

**KAWAI**  
**DIGITAL PIANO**

*L1*

**OWNER'S MANUAL**

Thank you for choosing this Kawai L1 Digital Piano.  
 Your new L1 is a high-quality instrument offering the very latest in leading-edge music technology.  
 This manual contains valuable information that will help you make full use of your L1 piano's  
 many capabilities. Please read it carefully and keep it handy for further reference.

## TABLE OF CONTENTS

	Page
Important Safety Instructions .....	3
Assembling The Stand .....	6
Part Names .....	8
Getting Started .....	10
1. Basic Operations .....	10
2. Dual .....	10
3. Reverb .....	11
4. Demonstration Song .....	11
5. Concert Magic .....	12
6. Selecting A Touch Type .....	15
7. Transpose .....	16
8. Metronome .....	17
Using The Recorder .....	18
1. Easy Recording .....	18
2. Playing Back A Song .....	18
3. Deleting A Song .....	18
Function Mode .....	19
1. Tuning .....	20
2. MIDI Channel .....	20
3. MIDI Local Control On/Off .....	20
4. Turning Mult-Timbral Mode On/Off .....	21
5. Transmit MIDI Program Change On/Off .....	22
6. Concert Magic Mode 1/2 .....	22
MIDI .....	23
Concert Magic Song List .....	24
Demo Song List .....	25
Specifications .....	25
MIDI Implementation Chart .....	26

# Important Safety Instructions

## SAVE THESE INSTRUCTIONS

INSTRUCTIONS PERTAINING TO A RISK OF FIRE, ELECTRIC SHOCK, OR INJURY TO PERSONS

**CAUTION**

RISK OF ELECTRIC SHOCK  
DO NOT OPEN

**WARNING**

TO REDUCE THE RISK OF FIRE OR ELECTRIC SHOCK, DO NOT EXPOSE THIS PRODUCT TO RAIN OR MOISTURE.

**AVIS : RISQUE DE CHOC ELECTRIQUE - NE PAS OUVRIR.**

TO REDUCE THE RISK OF ELECTRIC SHOCK, DO NOT REMOVE COVER (OR BACK).  
NO USER-SERVICEABLE PARTS INSIDE. REFER SERVICING TO QUALIFIED SERVICE PERSONNEL.

The lightning flash with arrowhead symbol, within an equilateral triangle, is intended to alert the user to the presence of uninsulated "dangerous voltage" within the product's enclosure that may be of sufficient magnitude to constitute a risk of electric shock to persons.

The exclamation point within an equilateral triangle is intended to alert the user to the presence of important operating and maintenance (servicing) instructions in the literature accompanying the product.

**Examples of Picture Symbols**

	denotes that care should be taken. The example instructs the user to take care not to allow fingers to be trapped.
	denotes a prohibited operation. The example instructs that disassembly of the product is prohibited.
	denotes an operation that should be carried out. The example instructs the user to remove the power cord plug from the AC outlet.

**Read all the instructions before using the product.**

**WARNING - When using electric products, basic precautions should always be followed, including the following.**

**WARNING**

Indicates a potential hazard that could result in death or serious injury if the product is handled incorrectly.

**The product should be connected to an AC outlet of the specified voltage.**

120V

230V

240V

- Use the AC adapter supplied with the product or one recommended by Kawai.
- If you are going to use an AC power cord, make sure that its has the correct plug shape and conforms to the specified power voltage.
- Failure to do so may result in fire.

**Do not insert or disconnect the power cord plug with wet hands.**

Doing so may cause electric shock.

**When using the headphones, do not listen for long periods of time at high volume levels.**

Doing so may result in hearing problems.

Do not disassemble, repair or modify the product.



Doing so may result in product breakdown, electric shock or short-circuit.

When disconnecting the AC power cord's plug, always hold the plug and pull it to remove it.

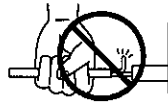

● Pulling the AC power cord itself may damage the cord, causing a fire, electric shock or short-circuit.

If the product will not be used for a long time, unplug the AC power cord from the AC outlet.



● Failure to do so may cause fire in case of lightning.  
● Failure to do so may over-heat the product, resulting in fire.

This product may be equipped with a polarized line plug (one blade wider than the other). This is a safety feature. If you are unable to insert the plug into the outlet, contact an electrician to replace your obsolete outlet. Do not defeat the safety purpose of the plug.

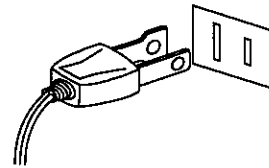

## CAUTION

Indicates a potential hazard that could result in injury or damage to the product or other

Do not use the product in the following areas.

- Areas, such as those near windows, where the product is exposed to direct sunlight
- Extremely hot areas, such as near a heater
- Extremely cold areas, such as outside
- Extremely humid areas
- Areas where a large amount of sand or dust is present
- Areas where the product is exposed to excessive vibrations

Using the product in such areas may result in product breakdown.

Before connecting cords, make sure that the power to this product and other devices is turned OFF.



Failure to do so may cause breakdown of this product and other devices.

Take care not to allow any foreign matter to enter the product.

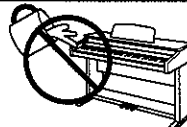

Entry of water, needles or hair pins may result in breakdown or short-circuit.

Do not drag the product on the floor. Take care not to drop the product.

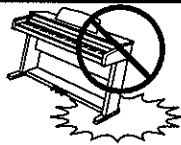

Please lift up the product when moving it. Please note that the product is heavy and must be carried by more than two persons. Dropping the product may result in breakdown.

Do not place the product near electrical appliances such as TVs and radios.

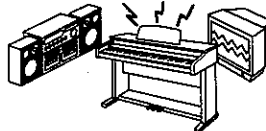

● Doing so may cause the product to generate noise.  
● If the product generates noise, move the product sufficiently away from the electrical appliance or connect it to another AC outlet.

When connecting the AC power cord and other cords, take care not to get them tangled.

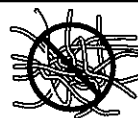

Failure to do so may damage them, resulting in fire, electric shock or short-circuit.

**Do not wipe the product with benzene or thinner.**



- Doing so may result in discoloration or deformation of the product.
- When cleaning the product, put a soft cloth in lukewarm water, squeeze it well, then wipe the product.

**Do not stand on the product or exert excessive force.**



- Doing so may cause the product to become deformed or fall over, resulting in breakdown or injury.

**The product should be located so that its location or position does not interfere with its proper ventilation.**

**The product should be serviced by qualified service personnel when:**

- The power supply cord or the plug has been damaged.
- Objects have fallen, or liquid has been spilled into the product.
- The product has been exposed to rain.
- The product does not appear to operate normally or exhibits a marked change in performance.
- The product has been dropped, or the enclosure damaged.

### **Notes on Repair**

Should an abnormality occur in the product, immediately turn the power OFF, disconnect the power cord plug, and then contact the shop from which the product was purchased.

- **This digital piano is for household use and is not intended for commercial use.**

### **CAUTION:**

To prevent electric shock, match wide blade of plug to wide slot, fully insert.

### **ATTENTION:**

Pour éviter les chocs électriques, introduire la lame la plus large de la fiche dans la borne correspondante de la prise et pousser jusqu'au fond.

### **Instruction for AC power cord (U.K.)**

Do not plug either terminal of the power cord to the ground of the AC outlet on the wall.

### **FCC Information**

This equipment has been tested and found to comply with the limits for a Class B digital device, pursuant to Part 15 of the FCC Rules. These limits are designed to provide reasonable protection against harmful interference in a residential installation. This equipment generates, uses and can radiate radio frequency energy and, if not installed and used in accordance with the instructions, may cause harmful interference to radio communications.

If this equipment does cause harmful interference to radio or television reception, which can be determined by turning the equipment off and on, the user is encouraged to try to correct the interference by one or more of the following measures:

- Reorient or relocate the receiving antenna.
- Increase the separation between the equipment and receiver.
- Connect the equipment into an outlet on a different electrical circuit from the receiver.
- Consult the dealer or an experienced radio/TV technician for help.

### **Canadian Radio Interference Regulations**

This instrument complies with the limits for a class B digital apparatus, pursuant to the Radio Interference Regulations, C.R.C., c. 1374.

# ASSEMBLING THE STAND

---

Be sure that all parts are included before starting to assemble your unit.

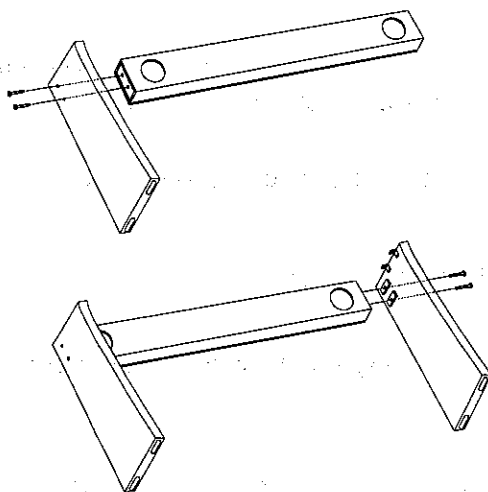
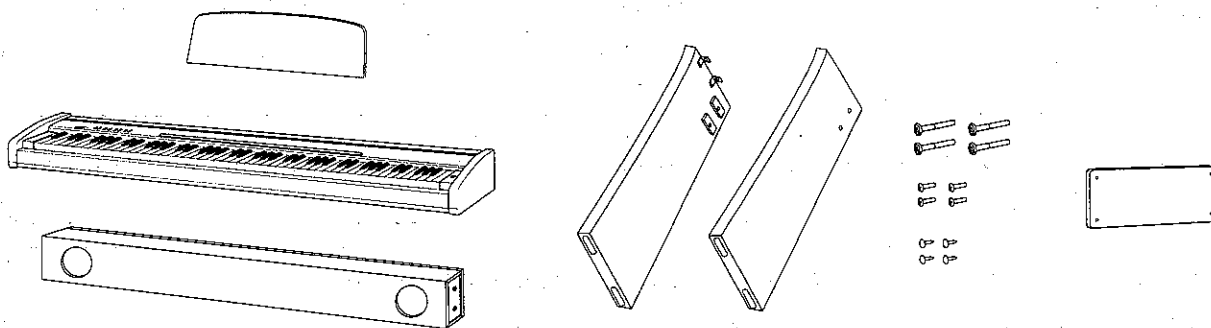

1. Fasten Side Boards and Speaker Box with four screws (long). It is recommended to assemble the stand so that the backside of the stand faces down.

2. Raise the stand up and make sure the screws are tight enough.

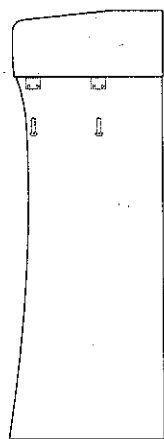

3. Put the piano on the stand carefully and fix with four screws (middle).

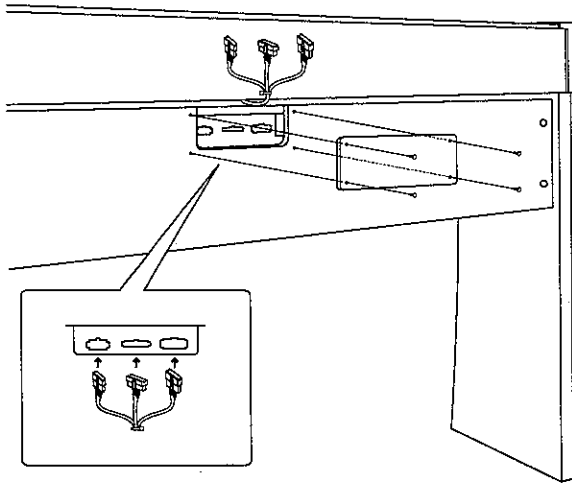

4. Connect the three cables to the connectors on the back of the speaker box. Make sure the connectors clicks in.

5. Put the Connector Cover with four screws (short).

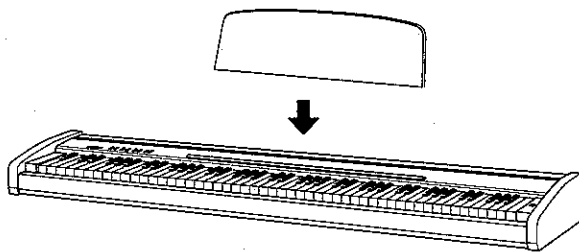

6. Insert the Music Rack in the slit on the top of the piano.

# PART NAMES

---

## VOLUME SLIDER (A)

Move the volume slider to the right to increase the instrument's volume. Move the slider to the left to decrease the volume.

## CONCERT MAGIC BUTTON (B)

Absolutely anyone can play a real music with Concert Magic... even if you've never taken a piano lesson in your life. All you have to do is to select a favorite song and tap any of the 88 keys. For more details, see page 12.

## DEMO BUTTON (C)

To listen to all the demos, simply press this button. The L1 piano will start the demo. Eight musical pieces will be played back until the DEMO button is pressed again to stop. To select a specific demo, see page 11. To stop the demo, press this button again.

## SOUND SELECT BUTTON (D)

Select the desired instrument by pressing this button repeatedly. You can also select a specific instrument directly by pressing one of the lowest eight white keys while holding down this button. For more details, see page 10.

## REVERB BUTTON (E)

This button adds REVERB to any sound which enhances the tonal quality and improves the acoustical realism. For more details, see page 11.

## RECORDER SECTION (F)

You can record your performance and play it back.

-PLAY/STOP button: Used to play back and stop a recorded song.

-RECORD button: Used to start recording a song.

## FUNCTION/METRONOME SECTION (G)

Use these buttons to select a touch type, transpose the keyboard, use the metronome, or control other features (including MIDI functions).

## FRONT PANEL

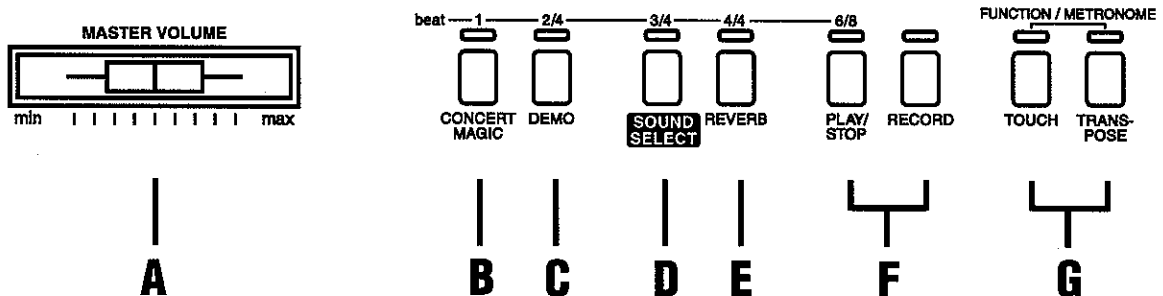



### DC IN JACK (H)

Connect the enclosed AC adaptor.

### LINE IN JACKS (I)

Connect a CD player or other sound source to play with.

### MIDI JACKS (J)

Use these jacks to connect the L1 piano with external MIDI devices.

### PEDAL JACK (K)

Connect the enclosed F-1r foot pedal. You can also connect an optional F-2r foot pedal which has soft pedal as well.

### HEADPHONES JACKS (L)

Used to connect up to two headphones to this digital piano.

### BOTTOM

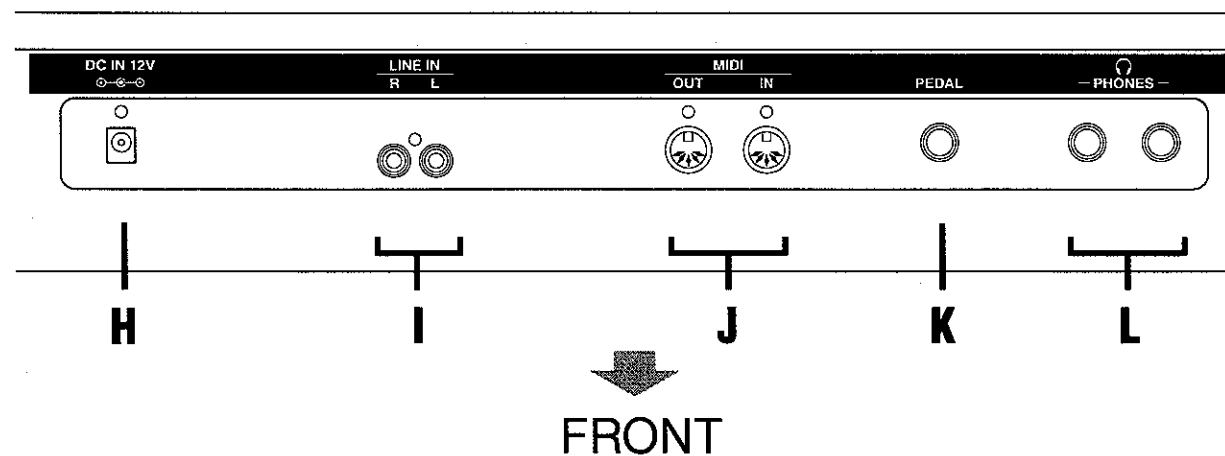

# GETTING STARTED

---

## 1. BASIC OPERATIONS



(1) Turn on the power.

(2) Adjust the volume.



Play a note on the keyboard and adjust the volume. (Moving the slider to the right raises the volume while moving to the left lowers it.)

(3) Choose a sound.



### Method 1

Pressing the SOUND SELECT button once will change the sound to the next. Press it repeatedly until the desired sound is selected.

### Method 2

While holding down the SOUND SELECT button, press one of the lowest 8 white keys to select a specific sound directly.

### Method 3

Press and hold the SOUND SELECT button more than one second to go back to Concert Grand.

### Note:

When a sound other than Classic Grand is selected, the LED indicator above the SOUND SELECT button will start flashing.

(4) Play.

Experiment by playing the different sounds.

### SOUND LIST

- 1 Classic Grand
- 2 Modern Piano
- 3 Electric Piano
- 4 Church Organ
- 5 Harpsichord
- 6 Vibraphone
- 7 Strings
- 8 Choir

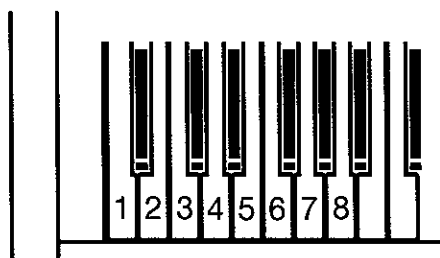

## 2. DUAL

With DUAL mode, you can layer two sounds together. To layer two

sounds, while holding down the SOUND SELECT button, press the desired two keys together at the lowest 8 white keys and the assigned two sounds will be layered.

### 3. REVERB

Reverb adds reverberation to the sound simulating the acoustic environment of a recital room, stage, or concert hall.



The Reverb is "ON" when the LED above the REVERB button is lit. Pressing the REVERB button once again turns the Reverb "OFF".

There are three types of Reverb in the L1. They are Room, Stage and Hall. To change the Reverb type, press one of the following buttons while holding down the REVERB button.

CONCERT MAGIC	Room
DEMO	Stage
SOUND SELECT	Hall

When the power is turned on, the REVERB function is automatically activated.

### 4. DEMONSTRATION SONG

The L1 piano has 8 built in demonstration songs for your listening enjoyment.



(1) Press the DEMO button and the demo song for Classic Grand will start. When the Classic Grand demo song is finished, the L1 piano will play all the other demo songs one at a time in random order.

(2) If you would like to listen to the demo for a particular sound, just press the desired key at the lowest 8 white keys while holding down the DEMO button.

(3) By pressing the SOUND SELECT button while the demo is playing, you can select the next sound's demo song.

(4) To stop the demo, press the DEMO button again at any time.

See page 25 for the list of demo songs.

## 5. CONCERT MAGIC

The great German composer Johann Sebastian Bach once said, "Playing the keyboard is simple. Just strike right keys at the right time." Many people wish it were that simple. The reality is very different of course. However, there is a way to make playing the keyboard very simple. You don't even have to strike right keys thanks to Concert Magic.

With Concert Magic, absolutely anyone can sit at the L1 piano and make real music... even if you've never taken a piano lesson in your life. To enjoy performing by yourself, you have only to select your favorite piece from 40 preprogrammed songs and tap any of the 88 keys with a steady rhythm and tempo. Concert Magic will provide the correct melody and accompaniment notes, regardless of which keys you press. Anybody, young or old, can enjoy Concert Magic from the moment they sit down at the L1 piano.

Now let's see how Concert Magic works.

### Selecting a Song

The 40 Concert Magic songs are assigned to each of the 40 white keys, classified in five groups by song category such as Children's Songs, American Classics, Christmas Songs.

All of the song titles are listed on page 24.

To select a song, press the key to which your desired song is assigned while holding down the CONCERT MAGIC button.

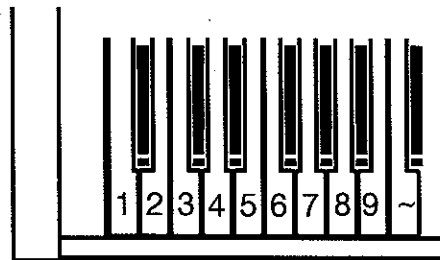

### Listening to the Song

If you have selected a song you are familiar with, you may want to play by yourself right away. However you may want to listen to the song first before playing it.

To listen, press the PLAY/STOP button. The L1 piano will start playing back the selected song.

If you want to listen to a different song, repeat the same procedure to select a song.

When you are finished listening to the song, press the PLAY/STOP button again to stop.

### **Performing a song**

Now you're ready to play yourself.

Tap out the rhythm of the selected song on any one of the 88 black or white keys on your piano keyboard. As you tap harder, the notes will get louder; as you tap softer, the notes will get quieter. As you tap faster, the notes speed up; as you tap slower, they will slow down correspondingly, just like regular piano playing.

Isn't it fun? You can sound like you've been playing for years just by pressing one key with one finger.

Concert Magic is a perfect method for small children to learn music, especially to develop a sense of rhythm. For older people who may think it is too late to learn the keyboard, Concert Magic is a good first step for them to begin with. With Concert Magic, your L1 piano can be enjoyed by anyone in the family, even those who have never touched a musical instrument in their life.

### **Concert Magic Song Arrangement Types**

After playing for a while with Concert Magic you may think that it's too easy and there is very little to learn.

While it is true that some of the songs are very easy to play, even for beginners, there are also some which will challenge you and require some practice to play beautifully. Each of the 40 Concert Magic songs falls into one of three different categories depending on the skill level required to perform them.

### **Easy Beat**

These are the easiest songs to play. To perform them, simply tap out a constant steady beat on any key on your piano keyboard.

Look at the following example, "Für Elise". Press the key with a steady sixteenth note rhythm.

Key on

x x x x x x x x x x x x x x x x x x



## Melody Play

These songs are also quite easy to play, especially if they are familiar to you. To perform them, tap out the rhythm of the melody on any one of the keys on your piano keyboard. Singing along as you tap the rhythm can be helpful.

Key on      x x x x x x x      x x x x x x x



Play “Twinkle, Twinkle, Little Star” for example. Follow the melody’s rhythm as shown.

When performing fast songs with Concert Magic, it is sometimes easier to tap two different keys with two fingers alternating. This allows you to play twice as fast as you can using only one finger on one key.

## Skillful

These songs range in difficulty from moderately difficult to difficult. To perform them, tap out the rhythm of both the melody and the accompaniment notes on any of the keys on your piano keyboard, like “Waltz of The Flowers” shown below.

Key on      x x x x x x x x x x x x



### **Concert Magic Song Demo**

There are three ways to listen to the Concert Magic songs in the DEMO mode.

#### **1. All Play**

Press the CONCERT MAGIC button and then press the PLAY/STOP button without selecting a song. The L1 piano will play back all the preset songs from one to another.

#### **2. Category Play**

Press the piano key to which the desired song is assigned while holding down the CONCERT MAGIC button. While still holding down the CONCERT MAGIC button, press the DEMO button. The L1 piano will play back the selected song and, then play the rest of songs in the same song category one after another.

#### **3. Random Play**

While holding down the CONCERT MAGIC button, press the DEMO button. The L1 piano will play back “Twinkle, Twinkle, Little Star” and, then play the rest of the songs in random order.

## **6. SELECTING A TOUCH TYPE**

When playing a piano, the volume of the sound produced increases in direct relation to how hard a key is struck. Your L1 piano lets you select from four different “Touch” types as follows:

### **NORMAL**

The standard setting which produces volume in direct proportion to your force on the keys. This setting is the most similar to an acoustic piano. The L1 piano automatically selects this Touch Type when the power is turned on.

### **LIGHT**

For those still developing finger strength, such as a child, a louder sound is produced even when the piano is played with a soft touch.

### **HEAVY**

Perfect for those with strong fingers or for practicing with a hard touch.

### **CONSTANT**

For tone colors like organ or harpsichord, and for playing some contemporary music with the piano sound, a constant loud sound is produced regardless of your force on the keys.



(1) To select the “LIGHT”, “HEAVY” or “CONSTANT” Touch Type, press one of the following keys on the keyboard while holding down the TOUCH button.

- Any C key: Selects the “LIGHT” Touch Type
- Any D key: Selects the “HEAVY” Touch Type
- Any E key: Selects the “CONSTANT” Touch Type

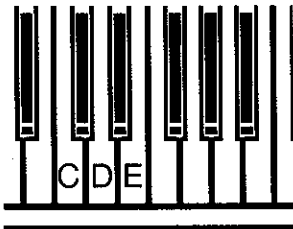

(2) Release both hands after selecting the Touch Type. When the TOUCH LED is off, the “NORMAL” Touch Type is automatically selected. When an alternative touch type is selected using the above procedure, the TOUCH LED will light. The TOUCH button is a toggle switch. Pressing the button turns on the LED. Pressing it a second time turns off the LED.

## 7. TRANSPOSE

The transpose function lets you raise or lower the piano’s key in half steps. This is especially useful when you have learned a song in one key and have to play it in another key. The transpose feature allows you to play the song in the original key, but hear it in another key.

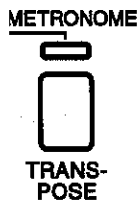

(1) While holding down the TRANSPOSE button, press any key on the L1 keyboard to select a new transposed key. The LED above the TRANSPOSE button will be lit. If the key of “C” is selected the TRANSPOSE button will not light. (When power is first turned “on”, the key is set to C.) When any key other than “C” is selected the TRANSPOSE LED will light. The piano can be transposed up to 5 half steps high (F) or 6 half steps lower (F#).

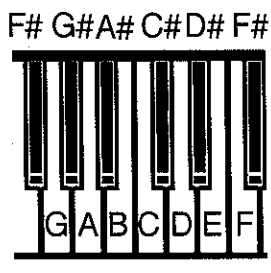

(2) To turn off the TRANSPOSE function, press the TRANSPOSE button again. The TRANSPOSE LED will go off and the key of the piano will return to C. Whenever the TRANSPOSE LED is on, the L1 piano will be transposed to your desired key.



## 8. METRONOME

The L1 piano's metronome function can help you practice the piano or record a song by providing a steady beat for you to play along with.

FUNCTION / METRONOME

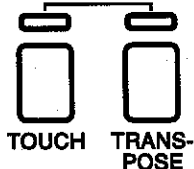

(1) To start the metronome, press the TOUCH and TRANSPOSE buttons at the same time.

(2) To turn off the metronome, press the TOUCH and TRANSPOSE buttons at the same time and the metronome will stop.

### Changing the Beat (Time Signature)

You can change the beat (time signature) of the metronome. The L1 piano has five beats (time signatures) to choose from, 1/4, 2/4, 3/4, 4/4, and 6/8. While holding down the TOUCH and TRANSPOSE buttons, select the desired beat (time signature) of the metronome by pressing the buttons assigned to that beat (time signature).

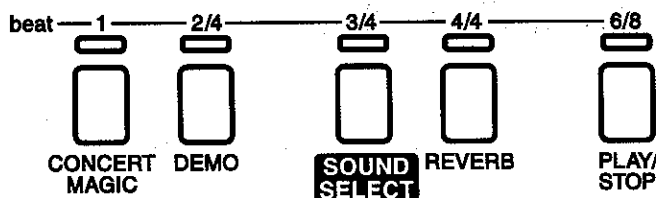

### Adjusting the Tempo

To adjust the tempo, use the lower white keys while holding down the TOUCH and TRANSPOSE buttons. You can directly enter the desired tempo in "Beats Per Minute" (BPM) or use the - or + keys to make it slower or faster. The tempo range is 30-300 beats per minute. Use the enclosed function label for your convenience.

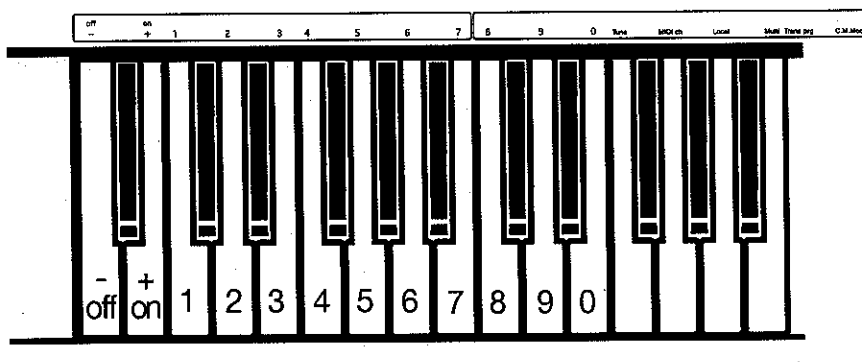

# USING THE RECORDER

---

## 1. EASY RECORDING

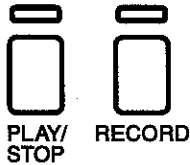

(1) Press the RECORD button. The LED indicator of the RECORD button starts blinking and the L1 piano will be ready for recording. To cancel the recording, press the RECORD button again.

(2) Begin playing some music on the piano. The LED indicators of the PLAY/STOP and RECORD buttons light and the L1 piano will automatically start recording with the first note you play. You can also start recording by pressing the PLAY/STOP button.

(3) Press the PLAY/STOP button when you have finished recording.

### NOTE:

Starting another recording will delete the song you previously recorded.

## 2. PLAYING BACK A SONG

(1) Press the PLAY/STOP button. The song will be played back using the same tone (sound) with which it was recorded.

(2) Press the PLAY/STOP button once again to stop the playback. If you do not press the PLAY/STOP button, playback will automatically stop when the song is finished.

## 3. DELETING A SONG

(1) Turn the power off.

(2) Turn the power back on again while holding down both the PLAY/STOP and RECORD buttons.

### NOTE:

The total memory capacity of the recorder is approximately 1,800 notes. When the recorder reaches its maximum capacity, the L1 piano will stop recording at this point. Any data recorded before the interruption will be retained.

The recorder memory will be saved after turning off the power. However, memory may be lost if the power remains off for more than 10 days.

# FUNCTION MODE

The Function Mode gives you access to many other useful features on your Ll piano.

The following functions can be selected in the Function Mode by pressing the appropriate key:

<b><u>Function</u></b>	<b><u>Default</u></b>
TUNING	A4=440.0Hz
MIDI CHANNEL SELECT	1 ch
MIDI LOCAL CONTROL ON/OFF	On
MULTI TIMBRAL MODE ON/OFF	Off
TRANSMIT MIDI PROGRAM CHANGE ON/OFF	On
CONCERT MAGIC MODE 1/2	Mode 1

When the power is turned on, these functions are always set to the default settings.

## OPERATION

(1) Press the key assigned for the function you want to edit while holding down the TOUCH and TRANSPOSE buttons simultaneously.

(2) While still holding down the TOUCH and TRANSPOSE buttons, use the number keys or - (off) / + (on) keys to change the value for the selected function.

(3) You can also select other functions and change the values successively.

(4) Release both the TOUCH and TRANSPOSE buttons to exit.

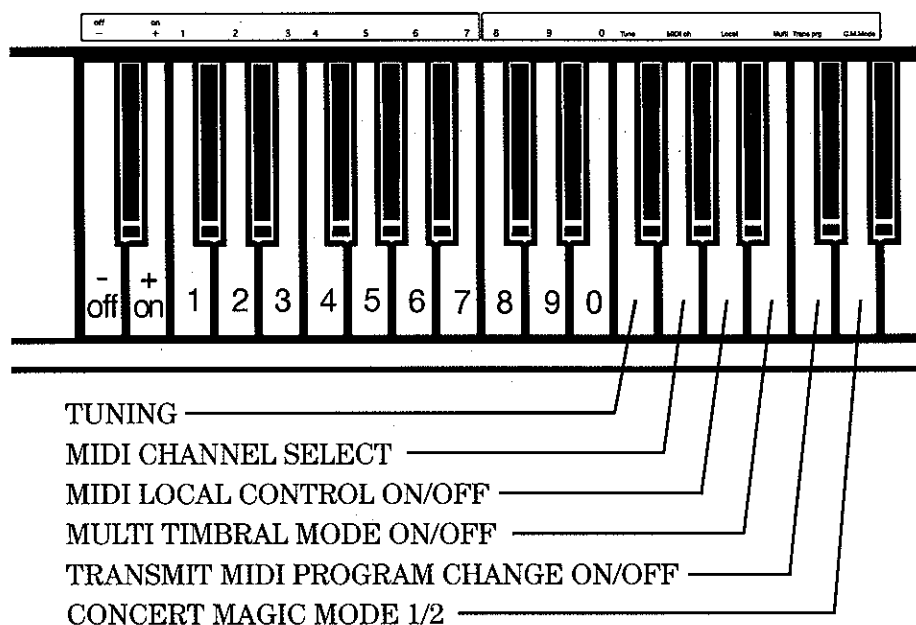

# 1. TUNING

This function allows you to adjust the piano's pitch to match recordings or other instruments in an ensemble.

(1) Press the "Tuning" key while holding down the TOUCH and TRANSPOSE buttons.

(2) While still holding down the TOUCH and TRANSPOSE buttons, use the +/- keys to lower/raise the pitch by 0.5Hz. Or you can directly enter the center A pitch as a three digit number by using the number keys. (EX: 440)

# 2. MIDI CHANNEL SELECT

In order to exchange MIDI information with another MIDI instrument, you must first set the two connected instruments to the same channel.

(1) Press the "MIDI ch" key while holding down the TOUCH and TRANSPOSE buttons.

(2) While still holding down the TOUCH and TRANSPOSE buttons, use the +/- keys to lower/raise the MIDI channel number. Or you can directly enter the MIDI channel number as a two digit number by using the number keys.

EX: For CH 1 press the 0 key then the 1 key.

For CH 12 press the 1 key then the 2 key.

# 3. MIDI LOCAL CONTROL ON/OFF

This function is used to control whether or not the sound from the piano will be heard when you play the keyboard. When MIDI LOCAL CONTROL is set to on you will hear the L1 piano when you play. When MIDI LOCAL CONTROL is set to off you will not hear any sound from the L1 piano when you play but the L1 piano's keyboard data will be transmitted through the MIDI jacks to an external MIDI device.

(1) Press the "Local" key while holding down the TOUCH and TRANSPOSE buttons.

(2) While still holding down the TOUCH and TRANSPOSE buttons, pressing the “off” key sets the Local Control to “off”. If you press the “on” key, this function returns to “on”.

## 4. TURNING MULTI-TIMBRAL MODE ON/OFF

Normally, the procedure described in the MIDI CHANNEL SELECT section is used to transmit or receive data on only one MIDI channel (any one of 1 through 16). But by turning the Multi-Timbral function “on”, you can receive data on more than one MIDI channel and simultaneously play a different sound on each channel. With this feature, you can connect the L1 piano to an external MIDI recorder or personal computer to create performances with a variety of timbres. The term “Multi-Timbral” is derived from the ability to play multiple timbres simultaneously.

### NOTE:

You can assign any sound of the L1 piano to any channel in the way you like by sending the correct Program Change Number to the L1 piano from an external MIDI device. Please refer to the list below for assignment of sound and program number.

(1) Press the “Multi” key while holding down the TOUCH and TRANSPOSE buttons.

(2) While still holding down the TOUCH and TRANSPOSE buttons, pressing the “off” key sets the Multi-Timbral mode to “off”. If you press the “on” key, this function returns to “on”.

<u>Sound</u>	<u>Program Number</u>	
	<u>Multi-Timbre “on”</u>	<u>Multi-Timbre “off”</u>
Classic Grand	1	1
Modern Piano	2	2
Electric Piano	5	3
Church Organ	20	4
Harpsichord	7	5
Vibraphone	12	6
Strings	49	7
Choir	53	8

## 5. TRANSMIT MIDI PROGRAM CHANGE ON/OFF

You can set the L1 piano if it should transmit Program Change Numbers via MIDI when the sound is changed on the control panel. Please refer to the list on page 21 for assignment of sound and program number.

(1) Press the “Trans prg” key while holding down the TOUCH and TRANSPOSE buttons.

(2) While still holding down the TOUCH and TRANSPOSE buttons, pressing the “off” key sets the L1 piano not to transmit the program change data corresponding to the sound selected on the panel. If you press the “on” key, this function returns to “on” and selecting a sound will transmit the data.

(3) You can also transmit the desired program change number directly by entering the number as a three digit number by using the number keys while holding down the TOUCH and TRANSPOSE buttons.

## 6. CONCERT MAGIC MODE 1/2

The L1 piano offers two ways to enjoy Concert Magic.

### Mode 1

Each of the 40 Concert Magic songs falls into one of three different categories depending on the skill level required to perform them. They are Easy Beat, Melody Play and Skillful. See page 13 for details.

### Mode 2

Regardless of which arrangement type a Concert Magic song is, with Mode 2 you can play any Concert Magic song by simply tapping any key with a constant steady beat.

(1) Press the “C.M.Mode” key while holding down the TOUCH and TRANSPOSE buttons.

(2) While still holding down the TOUCH and TRANSPOSE buttons, pressing the “+” key sets the Concert Magic mode to Mode 2. If you press the “-” key, the Concert Magic mode returns to Mode 1.

# MIDI

The term MIDI is an acronym for Musical Instrument Digital Interface, an international standard for connecting synthesizers, sequencers (MIDI recorders) and other electronic instruments so that they can exchange performance data.

The L1 is equipped with two MIDI jacks for exchanging data: MIDI IN and MIDI OUT. Each uses a special cable with a DIN connector.

MIDI IN : For receiving note, program change and other data.

MIDI OUT : For sending note, program change and other data.

## MIDI EXAMPLES

### (1) Connection to another MIDI compatible keyboard or sound generator module

When connected as shown in the illustration, data on how the digital piano is played (which keys are struck) can be sent to another MIDI instrument. Plus, the sound from the L1 can be layered over the sound of the other instrument.



### (2) Connection to an external sequencer

When connected as shown in the illustration, you can record songs played on the L1 with a MIDI recorder, and use the L1's tones (such as piano, harpsichord and vibraphone, etc.) controlled by the L1's MULTI-TIMBRAL MODE function to create a multi-layer MIDI recording.

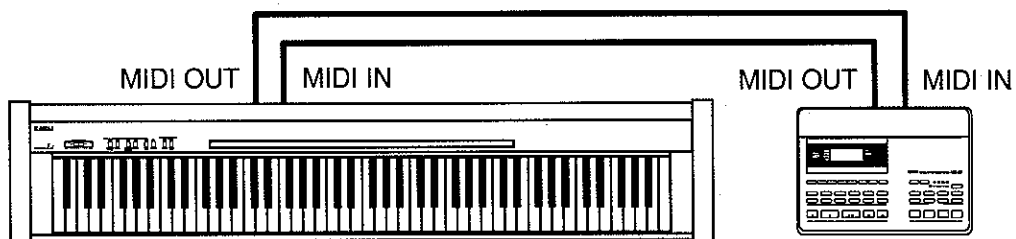

# CONCERT MAGIC SONG LIST

---

Category	#	Song Title	Arrangement Type
Children's Songs	1	Twinkle, Twinkle, Little Star	MP
	2	I'm A Little Teapot	MP
	3	Mary Had A Little Lamb	MP
	4	London Bridge	MP
	5	Row, Row, Row Your Boat	MP
	6	Frère Jaques	MP
	7	Old MacDonald Had A Farm	MP
Christmas Songs	8	Hark The Herald Angels Sing	MP
	9	Jingle Bells	MP
	10	Deck The Halls	MP
	11	O Come All Ye Faithful	MP
	12	Joy To The World	MP
	13	Silent Night	MP
	14	We Wish You A Merry Christmas	MP
American Classics	15	Battle Hymn Of The Republic	MP
	16	Yankee Doodle	MP
	17	Danny Boy	EB
	18	Clementine	MP
	19	Auld Lang Syne	MP
	20	Oh Susanna	SK
	21	Camptown Races	MP
	22	When The Saints Go Marching In	EB
	23	The Entertainer	SK
	Classical Selections	24	William Tell Overture
25		Andante (Haydn)	MP
26		Für Elise	EB
27		Clair De Lune	SK
28		Skater's Waltz	SK
29		Blue Danube Waltz	SK
30		Gavotte (Gossec)	SK
31		Waltz Of The Flowers	SK
Special Occations	32	Bridal Chorus	MP
	33	Wedding March	SK
	34	Pomp And Circumstance	SK
International Songs	35	When Irish Eyes Are Smiling	EB
	36	Hava Nagilah	EB
	37	Ich Bin Ein Musikant	SK
	38	Funicli Funicla	SK
	39	La Marseillaise	MP
	40	La Bamba	SK



# DEMO SONG LIST

---

Classic Grand	Rhapsodie No.2 / Brahms
Modern Piano	KAWAI original
Electric Piano	KAWAI original
Church Organ	Toccata / Eugene Gigout
Harpichord	French Suite No.6 / Bach
Vibraphone	KAWAI original
Strings	Le quattoro stagioni "La Primavera" / Vivaldi
Choir	KAWAI original

# SPECIFICATIONS

---

Keyboard	88 Weighted Keys with Advanced Hammer Action II
Touch Type	4 Types (Normal, Light, Heavy, Constant)
Max Polyphony	32 Notes
Tones	8 Tones (Classic Grand, Modern Piano, Electric Piano, Church Organ, Harpichord, Vibraphone, Strings, Choir)
Reverb	Room, Stage, Hall
Recorder	Approximately 1,800 Notes
Metronome	Beat: 1/4, 2/4, 3/4, 4/4, 6/8    Tempo: 30-300 BPM
Other Functions	Dual, Transpose, Tuning, Concert Magic (40 Songs), Touch Curves (Normal, Light, Heavy, Constant), MIDI Functions, 8 Demo Songs
Pedals	F-1r Foot Switch (Damper Pedal)
Jacks	Headphones x 2, Pedal, MIDI IN/OUT, LINE IN (L, R), DC IN
Speakers	12 cm x 2 (4 3/4"), 7 W x 2
Dimensions	136 x 27 x 76 (cm), 53 1/2" x 10 3/4" x 29 3/4"
Weight	30.0 kg ( 66 lbs.)

Specifications are subject to change without notice.

**KAWAI**