

# TASCAM

D01258820B

# DP-24SD

## Digital Portastudio

### OWNER'S MANUAL

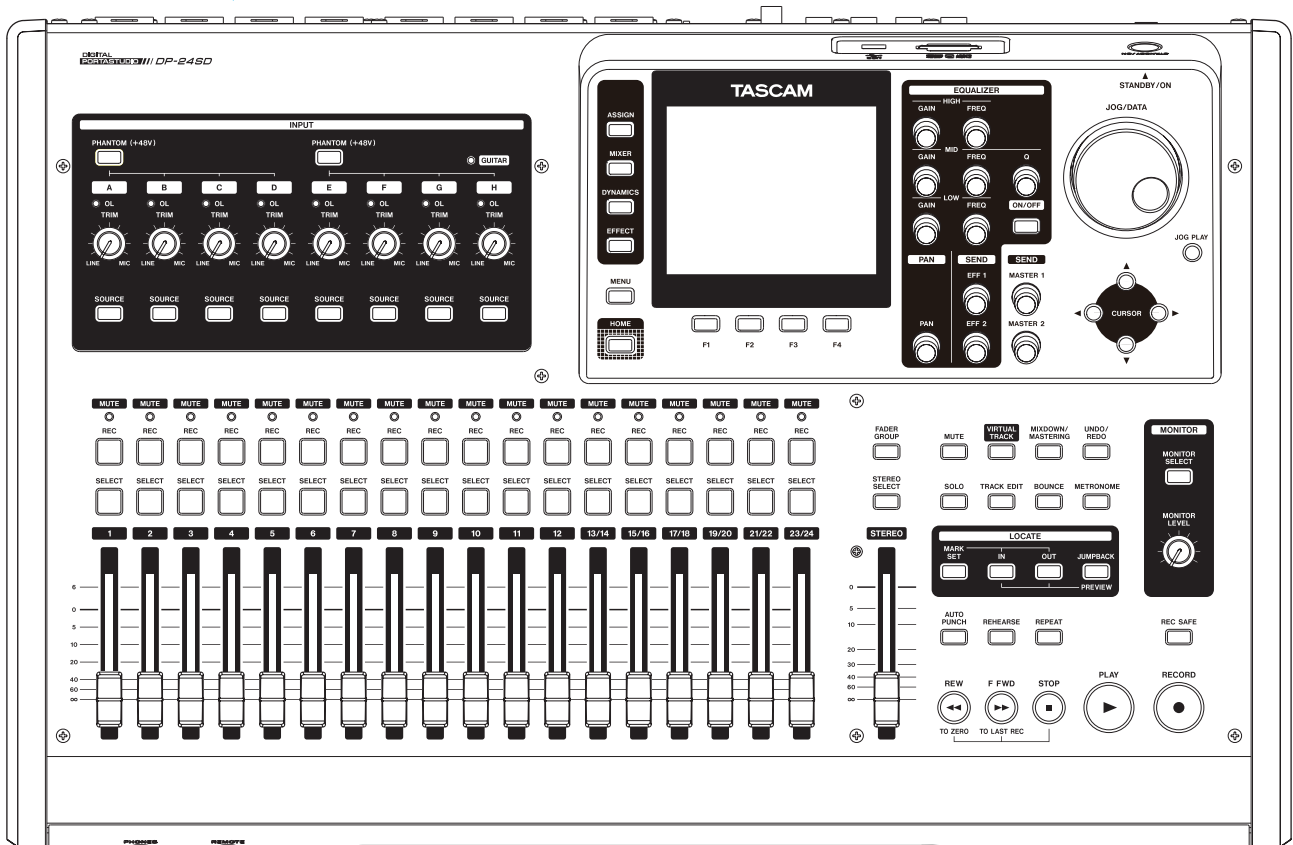

# IMPORTANT SAFETY PRECAUTIONS

**WARNING: TO PREVENT FIRE OR SHOCK HAZARD, DO NOT EXPOSE THIS APPLIANCE TO RAIN OR MOISTURE.**

— For U.S.A. —

## INFORMATION TO THE USER

This equipment has been tested and found to comply with the limits for a Class B digital device, pursuant to Part 15 of the FCC Rules. These limits are designed to provide reasonable protection against harmful interference in a residential installation. This equipment generates, uses, and can radiate radio frequency energy and, if not installed and used in accordance with the instruction manual, may cause harmful interference to radio communications. However, there is no guarantee that interference will not occur in a particular installation. If this equipment does cause harmful interference to radio or television reception, which can be determined by turning the equipment off and on, the user is encouraged to try to correct the interference by one or more of the following measures.

- a) Reorient or relocate the receiving antenna.
- b) Increase the separation between the equipment and receiver.
- c) Connect the equipment into an outlet on a circuit different from that to which the receiver is connected.
- d) Consult the dealer or an experienced radio/TV technician for help.

## CAUTION

Changes or modifications to this equipment not expressly approved by TEAC CORPORATION for compliance could void the user's authority to operate this equipment.

## For Canada

THIS CLASS B DIGITAL APPARATUS COMPLIES WITH CANADIAN ICES-003.

CET APPAREIL NUMERIQUE DE LA CLASSE B EST CONFORME A LA NORME NMB-003 DU CANADA.

## Declaration of Conformity

Responsible party: TEAC AMERICA, INC.

Address: 1834 Gage Road, Montebello,  
California, U.S.A.



Telephone number: 1-323-726-0303

This device complies with Part 15 of the FCC Rules. Operation is subject to the following two conditions: (1) this device may not cause harmful interference, and (2) this device must accept any interference received, including interference that may cause undesired operation.



This product complies with the European Directives request and the other Commission Regulations.

# IMPORTANT SAFETY INSTRUCTIONS

- 1 Read these instructions.
- 2 Keep these instructions.
- 3 Heed all warnings.
- 4 Follow all instructions.
- 5 Do not use this apparatus near water.
- 6 Clean only with dry cloth.
- 7 Do not block any ventilation openings. Install in accordance with the manufacturer's instructions.
- 8 Do not install near any heat sources such as radiators, heat registers, stoves, or other apparatus (including amplifiers) that produce heat.
- 9 Do not defeat the safety purpose of the polarized or grounding-type plug. A polarized plug has two blades with one wider than the other. A grounding type plug has two blades and a third grounding prong. The wide blade or the third prong are provided for your safety. If the provided plug does not fit into your outlet, consult an electrician for replacement of the obsolete outlet.
- 10 Protect the power cord from being walked on or pinched particularly at plugs, convenience receptacles, and the point where they exit from the apparatus.
- 11 Only use attachments/accessories specified by the manufacturer.
- 12 Use only with the cart, stand, tripod, bracket, or table specified by the manufacturer, or sold with the apparatus. When a cart is used, use caution when moving the cart/apparatus combination to avoid injury from tip-over.



- 13 Unplug this apparatus during lightning storms or when unused for long periods of time.
- 14 Refer all servicing to qualified service personnel. Servicing is required when the apparatus has been damaged in any way, such as power-supply cord or plug is damaged, liquid has been spilled or objects have fallen into the apparatus, the apparatus has been exposed to rain or moisture, does not operate normally, or has been dropped.

- The apparatus draws nominal non-operating power from the AC outlet with its POWER or STANDBY/ON switch not in the ON position.
- The mains plug is used as the disconnect device, the disconnect device shall remain readily operable.
- Caution should be taken when using earphones or headphones with the product because excessive sound pressure (volume) from earphones or headphones can cause hearing loss.
- If you are experiencing problems with this product, contact TEAC for a service referral. Do not use the product until it has been repaired.

## CAUTION

- Do not expose this apparatus to drips or splashes.
- Do not place any objects filled with liquids, such as vases, on the apparatus.
- Do not install this apparatus in a confined space such as a book case or similar unit.
- The apparatus should be located close enough to the AC outlet so that you can easily grasp the power cord plug at any time.
- If the product uses batteries (including a battery pack or installed batteries), they should not be exposed to sunshine, fire or excessive heat.
- CAUTION for products that use replaceable lithium batteries: there is danger of explosion if a battery is replaced with an incorrect type of battery. Replace only with the same or equivalent type.

## WARNING

- Products with Class I construction are equipped with a power supply cord that has a grounding plug. The cord of such a product must be plugged into an AC outlet that has a protective grounding connection.

# Safety Information

## ■ For European Customers

### Disposal of electrical and electronic equipment

- (a) All electrical and electronic equipment should be disposed of separately from the municipal waste stream via designated collection facilities appointed by the government or the local authorities.
- (b) By disposing of the electrical and electronic equipment correctly, you will help save valuable resources and prevent any potential negative effects on human health and the environment.
- (c) Improper disposal of waste equipment can have serious effects on the environment and human health as a result of the presence of hazardous substances in electrical and electronic equipment.
- (d) The crossed out wheeled dust bin symbol indicates that electrical and electronic equipment must be collected and disposed of separately from household waste.



- (e) The return and collection systems are available to the end users. For more detailed information about disposal of old electrical and electronic equipment, please contact your city office, waste disposal service or the shop where you purchased the equipment.

<b>1 – Introduction .....</b>	<b>8</b>	Connecting other equipment .....	28
Features .....	8	Front panel .....	28
Items included with the product .....	8	Rear panel .....	29
Conventions used in this manual .....	8	Adjusting the contrast.....	29
Trademarks.....	9	<b>5 - Song Management .....</b>	<b>30</b>
Precautions for placement and use.....	9	Editing names.....	30
Beware of condensation.....	9	Loading a song .....	30
Cleaning the unit.....	9	Creating a new song .....	31
About SD cards .....	9	Saving a song .....	31
Precautions for use .....	9	Viewing song information .....	32
Using the TEAC Global Site.....	9	Copying songs .....	32
User registration.....	9	Erasing songs.....	32
<b>2 - Quick Guide.....</b>	<b>10</b>	Protecting songs.....	33
Playback and mixing.....	10	Deleting unnecessary audio data from a song.....	33
Preparation.....	10	Changing a song name.....	34
Listening to the demo song .....	10	<b>6 - Basic Recording.....</b>	<b>35</b>
Recording and mastering .....	11	Selecting the input sources.....	35
Creating a new song .....	12	Assigning inputs.....	35
Connecting and setting the input sources.....	12	Assigning to a mono track .....	35
Setting the guitar as the recording source for		Assigning to a stereo track .....	35
TRACK 1.....	13	Assigning to a stereo bus.....	35
Adjusting and monitoring the input level .....	13	Checking the assignment .....	35
Recording a guitar to TRACK 1 .....	13	Canceling an assignment.....	35
Playing back the recording.....	14	Using phantom power .....	36
Recording a guitar to TRACK 2 .....	14	Monitoring.....	36
Recording a vocal to TRACK 3.....	15	Monitor selection.....	36
Mixing the tracks.....	16	OL indicators and level meters .....	36
Mastering a recording .....	16	Peak hold display .....	37
Shutting down .....	18	Setting the Mixer screen .....	37
<b>3 – Names and Functions of Parts .....</b>	<b>19</b>	Using the input equalizer.....	37
Top panel .....	19	DIGITAL TRIM setting (Track only).....	38
Front panel.....	22	Sending signals to internal/external effects ....	38
Rear panel.....	23	Enabling insert effects .....	38
Home screen.....	23	Setting the stereo position.....	38
Menu structure .....	24	Changing the signal phase.....	38
Screen operations.....	25	Checking the fader level.....	39
<b>4 – Preparation.....</b>	<b>26</b>	Solo .....	39
Inserting and removing SD cards.....	26	Muting tracks.....	39
Inserting an SD card .....	26	Rehearsing the recording .....	39
Removing the card .....	26	Making the first recording .....	39
About write-protected SD cards .....	26	Multitrack recording .....	40
Powering the unit .....	26	Setting the tracks for recording.....	40
Changing the outlet plug.....	26	Setting track pan and level.....	40
Start-up & Shutdown .....	27	Input selection and assignment .....	40
Starting up the unit.....	27	Setting input levels.....	40
Shutting down .....	27	Recording.....	40
Setting the date and time .....	27	Undoing an operation.....	40
Preparing an SD card for use .....	28	Undo feature settings.....	40
Recorder modes .....	28	Undoing the last operation (single undo).....	41
		Undoing older operations (multiple undo) .....	41

# Contents

<b>7 - Recorder Functions.....</b>	<b>42</b>	Inserting a dynamic effect.....	53
Punching in and out.....	42	Editing a dynamic effect.....	53
Using a foot switch to punch in/out.....	42	Guitar effects.....	53
Setting the foot switch.....	42	Inserting a guitar effect.....	53
Bouncing tracks.....	43	Editing guitar effects.....	53
Performing the track bouncing.....	43	Calling effects from the guitar effect library.....	54
Checking the result.....	43	Saving guitar effects in the library.....	54
Direct Location Function.....	43	Send effects.....	54
Locating directly a specified time.....	44	Using send effects.....	54
Locating directly a specified measure/beat.....	44	Editing send effects.....	54
Location marks.....	44	Calling the send effect library.....	54
Setting a location mark.....	44	Saving send effects in the library.....	54
Skipping to location marks.....	44		
Deleting a location mark.....	44	<b>10 - Mixing Down and Mastering Tracks.....</b>	<b>55</b>
Returning to zero or the last recording position.....	44	Mixing down tracks.....	55
Fast forwarding and rewinding.....	45	Levels and balance.....	55
Cueing with the JOG/DATA dial.....	45	Fader group.....	55
Jogging while viewing a waveform.....	45	Stereo position (panning).....	55
Jogging while listening to audio.....	45	Track equalizer.....	55
Repeat playback.....	45	Send effects.....	56
Setting IN/OUT points.....	45	Creating a master file.....	56
Using repeat playback.....	46	Setting the start and end points.....	56
Jumpback playback.....	46	Creating a master file.....	57
Checking cueing points (preview).....	46	Exiting Mixdown mode.....	57
Automatic punching in and out.....	46	Checking the master file.....	57
Setting punch-in/out points.....	47	Ending master file checking.....	57
Checking punch-in/out points.....	47	Finishing up a master file (mastering).....	58
Rehearsing with automatic punching.....	47	Mastering procedures.....	58
Recording with automatic punching.....	48	Using the mastering equalizer.....	59
Checking a take.....	48	Using mastering compression.....	59
Virtual tracks.....	48	Using normalize.....	60
Recording to virtual tracks.....	48	Exiting Mastering mode.....	60
Assigning virtual tracks.....	48		
		<b>11 - Various Other Functions.....</b>	<b>61</b>
<b>8 - Track Editing.....</b>	<b>49</b>	Metronome.....	61
Overview of track editing.....	49	Tuner function.....	62
Editing points.....	49	Setup (PREFERENCE).....	62
Basic editing procedures.....	49	Setting automatic power saving.....	63
Explanation of items.....	49	Setting automatic monitoring.....	63
COPY/PASTE.....	50	Setting the song name format.....	63
COPY/INSERT.....	50	Restoring the initial preference settings.....	63
MOVE/PASTE.....	51	Viewing information.....	64
MOVE/INSERT.....	51		
OPEN (Insert Silence).....	51	<b>12 - SD Card Management.....</b>	<b>65</b>
CUT (Remove Part).....	51	Quick formatting an SD card.....	65
SILENCE (Erase Part).....	52	Full formatting an SD card.....	66
CLONE TRACK (Track Duplication).....	52		
CLEAN OUT (Delete Track).....	52	<b>13 - Exchanging Data with a Computer.....</b>	<b>67</b>
		Operating system requirements.....	67
<b>9 - Using Built-In Effects.....</b>	<b>53</b>	Connecting to a computer.....	67
Dynamic effects.....	53	Disconnecting.....	68
		Track import and export.....	68

Importing tracks .....	68
Exporting tracks .....	69
Deleting files from the AudioDepot folder .....	70
<b>14 – Troubleshooting.....</b>	<b>71</b>
<b>15 – Messages .....</b>	<b>72</b>
General messages.....	72
<b>16 – Specifications .....</b>	<b>75</b>
Ratings .....	75
Input/output ratings.....	75
Analog audio input/output ratings .....	75
Control input/output ratings .....	75
Audio performance .....	75
Operating requirements .....	75
General .....	76
Dimensional drawings .....	76
Block diagram.....	77
Level diagram.....	78

# 1 – Introduction

Thank you very much for purchasing the TASCAM DP-24SD Digital Portastudio.

Before connecting and using the unit, please take time to read this manual thoroughly to ensure you understand how to properly set up and connect the unit, as well as the operation of its many useful and convenient functions. After you have finished reading this manual, please keep it in a safe place for future reference.

You can also download the Owner's Manual from the TEAC Global Site (<http://teac-global.com/>).

---

## Features

---

This unit uses SD cards for multitrack recording of up to 8 tracks and playback of up to 24 tracks simultaneously. Multiple tracks can be mixed down to stereo to create a master file by using the built-in mixer functions.

Master files can be transferred to a computer that is connected via USB. Moreover, since transferring data between the unit and a computer is possible, you can copy tracks and master files, and back up song files to a computer.

- 24-track Digital Multitrack Recorder that uses SD cards as recording media
- Supports SDHC standards for large capacity SD cards of up to 32GB
- Multitrack recorder functions include simultaneous 8 track recording + 24 track playback (44.1/48kHz, 16/24bit)
- 18+1 45mm faders (for track and master level adjustment)
- Each track has independent SELECT button and REC button
- +48V Phantom power supported mic input
- Eight balanced mic/line inputs (XLR/TRS combo jacks)
- High-impedance guitar input supported (INPUT H only: 6.3mm (1/4") TS phone jack)
- 3.5-inch large TFT color LCD display
- Independent 3-band equalizers for each input and playback track
- Mixing down to a dedicated master file possible
- Included mastering effects can be used on mix downs of master files
- Includes Reverb and various other effects that can be independently adjusted for each playback track
- Auto punch in/out function
- Track bounce function
- Track editing functions include COPY INSERT, COPY PASTE, MOVE INSERT, MOVE PASTE, OPEN, CUT, SILENCE, CLONE TRACK, and CLEAN OUT
- Undo and redo functions, including history level setting
- Locate Mark function
- Tuner and metronome functions
- Song data and WAVE files can be copied and backed up to a computer connected via USB2.0
- Punch in/out and other functions can be assigned to and controlled by a foot switch (TASCAM RC-3F, sold separately)

---

## Items included with the product

---

The DP-24SD package contains the following items.

Take care when opening the package to avoid damaging the items. Keep the packing materials for transportation in the future.

Please contact the store where you purchased this unit if any of these items are missing or have been damaged during transportation.

- Main unit .....x1
- AC adapter (PS-P1220E) .....x1
- SD memory card (inserted into the unit) .....x1
- Owner's Manual (this manual) .....x1

The warranty is included at the end of this manual.

### CAUTION

*Always use the included PS-P1220E AC adapter with this unit. Moreover, do not use the included AC adapter with other equipment. Doing so could cause malfunction, fire or electric shock.*

### NOTE

*The included AC adapter (PS-P1220E) is shipped with exchangeable outlet plugs. For details about changing the outlet plug, see "Changing the outlet plug" on page 26.*

---

## Conventions used in this manual

---

The following conventions are used in this manual.

- Buttons, connectors and other physical parts of this unit are written using a bold font like this: **MENU** button.
- Text displayed on the display of the unit appears like this: MENU.
- The four buttons beneath the LCD display (**F1** to **F4**) are function buttons. The functions displayed at the bottom of each screen are sometimes shown after the button names in parentheses. Example: **F1** (TIME LINE) button, **F4** (▶) button.
- SD and SDHC memory cards are called "SD cards".
- Text displayed on a computer monitor appears like this: OK.
- Additional information is provided as necessary in tips, notes and cautions

### TIP

*These are tips about how to use the unit.*

### NOTE

*These include additional explanations and special cases.*

### CAUTION

*Failure to follow these instructions could result in injury, equipment damage or lost data, for example.*



---

## Trademarks

---

- TASCAM and PORTASTUDIO are trademarks of TEAC Corporation, registered in the U.S. and other countries.
- SDHC Logo is a trademark of SD-3C, LLC.



- Windows, Windows XP, Windows Vista, Windows 7 and Windows 8 are either registered trademarks or trademarks of Microsoft Corporation in the United States and/or other countries.
- iMac, Mac OS and OS X are trademarks of Apple Inc.
- Pentium and Intel are trademarks of Intel Corporation in the U.S. and/or other countries.
- Other company names, product names and logos in this document are the trademarks or registered trademarks of their respective owners.

Any data, including, but not limited to information, described herein are intended only as illustrations of such data and/or information and not as the specifications for such data and/or information. TEAC Corporation disclaims any warranty that any use of such data and/or information shall be free from infringement of any third party's intellectual property rights or other proprietary rights, and further, assumes no liability of whatsoever nature in the event of any such infringement, or arising from or connected with or related to the use of such data and/or information.

This product is designed to help you record and reproduce sound works to which you own the copyright, or where you have obtained permission from the copyright holder or the rightful licensor. Please use the product appropriately. Under no circumstances will TEAC Corporation be responsible for the consequences of any illegal copying performed using the recorder.

---

## Precautions for placement and use

---

- The operating temperature should be between 5°C and 35°C (41°F and 95°F).
- Do not install in the following types of places. Doing so could degrade the sound quality and/or cause malfunctions.
  - Places with significant vibrations or that are otherwise unstable
  - Near windows or other places exposed to direct sunlight
  - Near heaters or other extremely hot places
  - Extremely cold places
  - Places with bad ventilation or high humidity
  - Very dusty locations
- Make sure that the unit is mounted in a level position for correct operation.
- Do not place any object on the unit for heat dissipation.
- Avoid installing this unit on top of any heat-generating electrical device such as a power amplifier.

---

## Beware of condensation

---

If the unit is moved from a cold to a warm place, or used after a sudden temperature change, there is a danger of condensation; vapor in the air could condense on the internal mechanism, making correct operation impossible. To prevent this, or if this occurs, let the unit sit for one or two hours at the new room temperature before using.

---

## Cleaning the unit

---

To clean the unit, wipe it gently with a soft dry cloth. Do not wipe the unit with chemical cleaning cloths, paint thinner, alcohol or other chemical agents because they could damage its surface or cause discoloration.

---

## About SD cards

---

This unit uses SD cards for recording and playback.

SD and SDHC cards that are at least 512 MB in size can be used.

A list of SD cards that have been confirmed for use with this unit can be found on our web site. Please access to a product page of this product from the TEAC Global Site (<http://teac-global.com>) to find the list or contact the TASCAM customer support service.

---

## Precautions for use

---

SD cards are delicate media. In order to avoid damaging a card or the card slot, please take the following precautions when handling them.

- Do not leave them in extremely hot or cold places.
- Do not leave them in extremely humid places.
- Do not let them get wet.
- Do not put things on top of them or twist them.
- Do not hit them.
- Do not remove or insert an SD card when the power is ON.

---

## Using the TEAC Global Site

---

You can download updates for this unit from the TEAC Global Site: <http://teac-global.com/>

In the TASCAM Downloads section, select the desired language to open the Downloads website page for that language.

---

## Product registration

---

Customers in the USA, please visit the following TASCAM website to register your TASCAM product online.

<http://tascam.com/>

# 2 - Quick Guide

## Playback and mixing

In this section, we will play back the demo song on the included SD card.

When this unit is purchased new, the SD card with the demo song on it is already installed in the unit, but we will start by explaining how to insert an SD card using the procedures below.

### Preparation

1. Insert the included SD card into the SD card slot on the rear panel. Be careful not to forcibly insert the card in the wrong direction. Doing so could damage the SD card slot or the SD card.

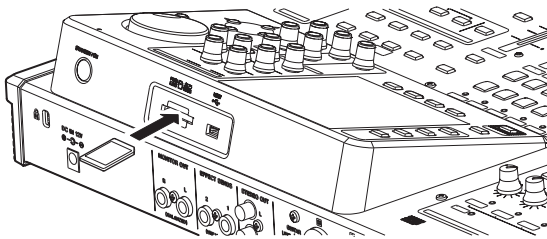

2. Connect the supplied AC adapter (PS-P1220E) to the DC IN 12V jack on the rear panel.

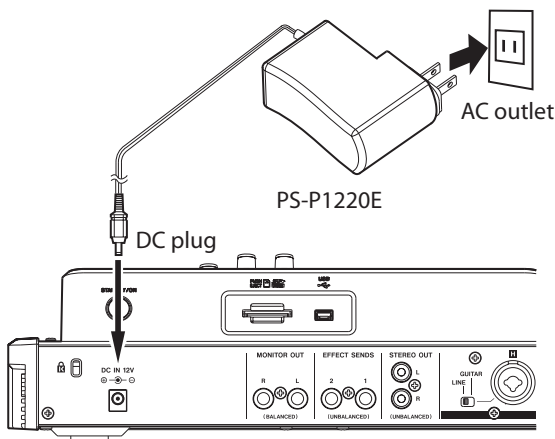

### CAUTION

Always use the included PS-P1220E AC adapter. Use of a different adapter could cause malfunction, fire or electric shock.

3. Connect headphones to the **PHONES** jack on the front panel.

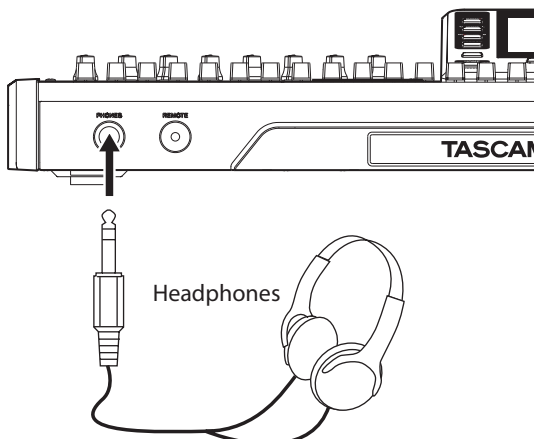

4. Press and hold the **STANDBY/ON** button for a few seconds on the rear panel to turn the power ON. When the unit starts, the Home screen appears on the display.

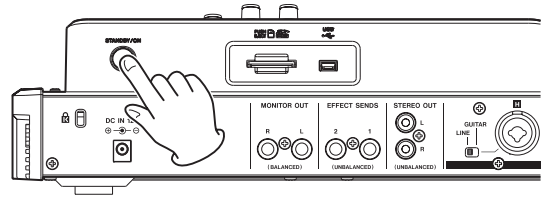

Start-up screen

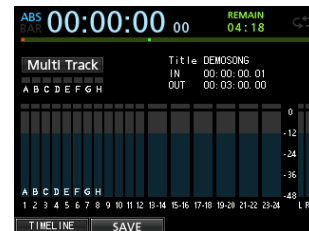

Home screen

### CAUTION

- Do not remove or insert an SD card when the power is ON. Always turn the power OFF (standby) before removing or inserting an SD card.
- When the power is on, do not cut the power to the unit by, for example disconnecting the power cord. All settings made since the last time you saved will not be saved. If you cut the power while an SD card is being accessed, all recorded songs and data may be damaged and cannot be recovered.
- Before turning the power ON, minimize the headphones volume and the volume on any monitoring system connected to this unit.

### TIP

If an amplifier or powered speakers are connected to the **MONITOR OUT** jacks, you can monitor using speakers.

## Listening to the demo song

The included SD card in the unit contains a demo song. We will use this demo song to practice listening to and mixing a recording.

1. Press the **HOME** button to open the Home screen.

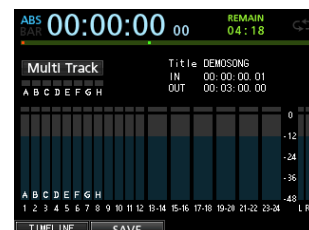

- When the recorder is stopped, press the **MENU** button to open the **MENU** screen.



- Use the **JOG/DATA** dial or the **CURSOR** (**▲/▼/◀/▶**) buttons to select (green highlight) **SONG**, and then press the **F4** (**▶**) button.

The **SONG LIST** screen appears.

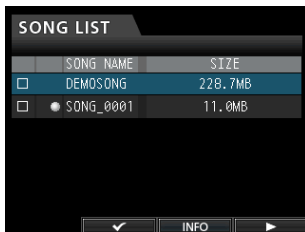

- Use the **JOG/DATA** dial or the **CURSOR** (**▲/▼**) buttons to select **DEMO SONG**, and then press the **F4** (**▶**) button to open a sub-menu.



- Use the **JOG/DATA** dial or the **CURSOR** (**▲/▼**) buttons to select **LOAD**, and then press the **F4** (**▶**) button.

The **SONG LOAD** pop-up window appears.

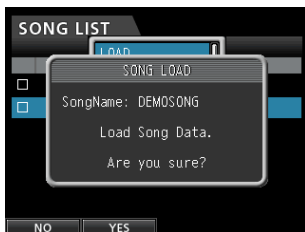

- Press the **F2** (**YES**) button to load the demo song. The demo song is loaded and the display returns to the **SONG LIST** screen.

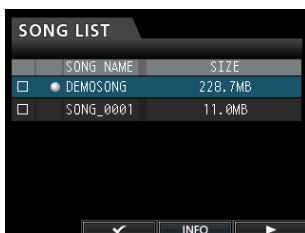

- Press the **HOME** button to return to the Home screen.
- Press the **PLAY** (**▶**) button, and raise the **TRACK 1** to 23/24 faders, the **STEREO** fader and the **MONITOR LEVEL** knob to listen to the demo song.

The **STEREO** fader adjusts the overall volume of **TRACK 1** to 23/24. The standard position of the **STEREO** fader is 0dB.

Use **TRACK 1** to 23/24 faders to adjust the balance of the tracks.

Use the **MONITOR LEVEL** knob to adjust the final monitoring volume.

- Press the **MIXER** button to open the **Mixer** screen.

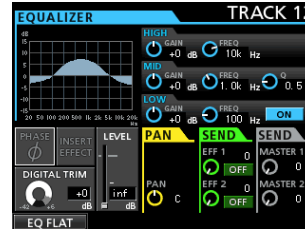

- Press the **SOURCE** button to select **INPUT A** to **H**, or press the **SELECT** button to select a track to be set, and then use the **PAN** knob to set the stereo signal position of each track.

### TIP

- Press the **STOP** (**■**) and **REW** (**◀◀**) (**TO ZERO**) buttons at the same time to return to the beginning of the song (**ZERO point**) (**TO ZERO function**).
- If you press the wrong button and open a different screen, press the **HOME** button to return to the Home screen at any time.

## Recording and mastering

In this section we will practice multitrack recording.

Here we will explain how to connect an electric guitar and rhythm guitar to **INPUT H**, and an external microphone to **INPUT B**.

In the following example, we will explain how to record a rhythm guitar part with an electric guitar to track 1 and a lead guitar part to track 2. Then, we will use the external microphone to record vocals to track 3. Finally, we will mix down the tracks to stereo.

We will assume that you have already followed the instructions in the previous section, and that you have connected the monitoring equipment, started the unit and inserted the **SD** card.

## 2 - Quick Guide

### Creating a new song

1. When the recorder is stopped, press the **MENU** button to open the MENU screen.



2. Use the **JOG/DATA** dial or the **CURSOR** (▲/▼/◀/▶) buttons to select (green highlight) **SONG**, and then press the **F4** (▶) button.

The **SONG LIST** screen appears.

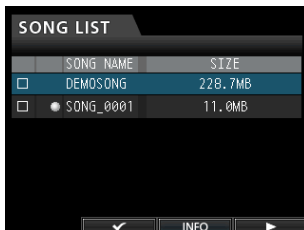

3. Press the **F4** (▶) button to open the sub-menu and then use the **JOG/DATA** dial or the **CURSOR** (▲/▼) buttons to select **CREATE**.

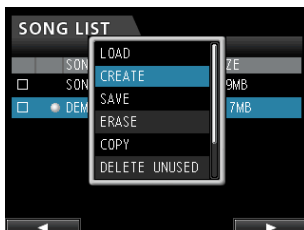

4. Press the **F4** (▶) button to open the **SONG CREATE** pop-up window.

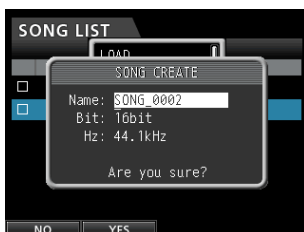

The created song is given the name **SONG\_0002**.

5. Change the name (title) of the song as necessary in the item **Name**. (See "Editing names" on page 30.)
6. Use the **CURSOR** (▲/▼) buttons to move the cursor (blue highlight) to select **Bit** (Bit rate), **Hz** (Sampling frequency), and then use the **JOG/DATA** dial to set.

7. Press the **F2** (YES) button.

The currently loaded song is saved and a new song is created.

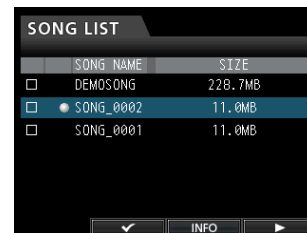

8. Press the **HOME** button to return to the Home screen.

### Connecting and setting the input sources

1. Connect an electric guitar to the **MIC/LINE INPUTS H** jack on the rear panel.

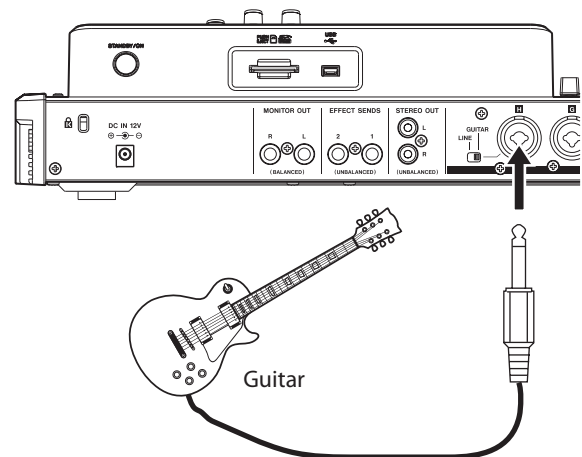

2. Set the **LINE-GUITAR** switch to **GUITAR** on the rear panel.

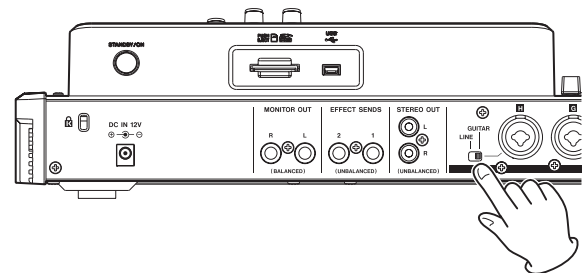

The **GUITAR** indicator lights.

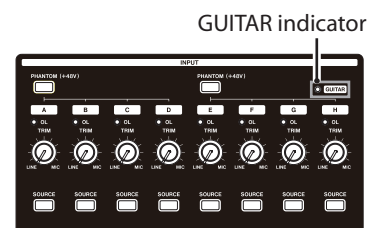

Now the guitar becomes the input source for **INPUT H**.

#### TIP

*When connecting an electric-acoustic guitar with a built-in preamp or an active-type electric guitar, or when using an effects pedal, for example, between the guitar and this unit, set the **LINE-GUITAR** switch to **LINE** on the rear panel.*

## Setting the guitar as the recording source for TRACK 1

When you press the **ASSIGN** button to open the Assign screen, the default screen setting for the recording source is **H** (INPUT A) for TRACK 1, **B** (INPUT B) for TRACK 2, **C** (INPUT C) for TRACK 3, and so on for **D** to **H** (INPUT D to H) for TRACK 4 to 8. (See "Assigning inputs" on page 35.)

Since initially the input source of the INPUT H is set as the recording source of the TRACK 8, you must change the recording source to TRACK 1.

Follow the procedure below to change the recording source of the TRACK 1.

1. Press the **ASSIGN** button to open the Assign screen.

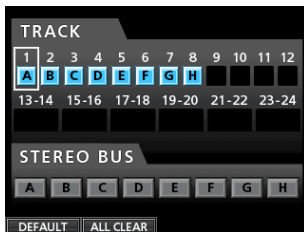

2. Use the **CURSOR** (**▲**/**▼**/**◀**/**▶**) buttons or press the **SELECT** button for TRACK 1 and align the cursor (frame) on the Assign screen with TRACK 1.
3. Use the **JOG/DATA** dial or the **SOURCE** button for INPUT H to set the recording source of TRACK 1 to H.

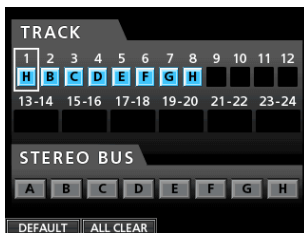

## Adjusting and monitoring the input level

1. Press the **HOME** button to return to the Home screen.

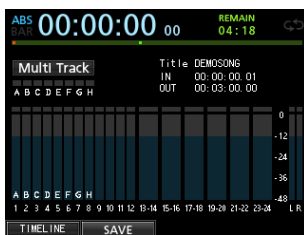

2. Press the **REC** button for TRACK 1.  
The **REC** button flashes and the unit enters recording standby.

3. Use the **TRIM** knob for INPUT H to adjust the guitar input level. Set the **TRIM** knob so that the **OL** indicator for INPUT H does not light even when the loudest sound to be recorded is input.

If the **OL** indicator continues to light even when the **TRIM** knob is turned down, the guitar signal itself is too loud. In this case, lower the output level on the guitar.

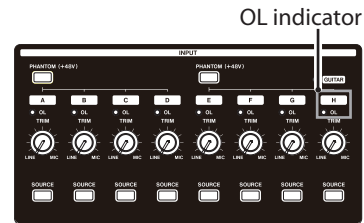

When you play the guitar, the input level is shown by the level meter for **1** (TRACK 1) on the display.

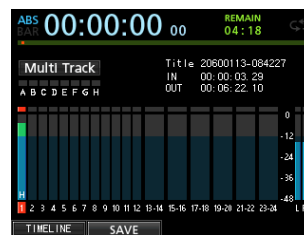

When you raise the fader for TRACK 1, the **STEREO** fader and the **MONITOR LEVEL** knob, you can hear the sound of the guitar through the headphones, and the **L** and **R** level meters move.

### NOTE

- You can use the **PAN** knob for TRACK 1 on the Mixer screen to set the stereo position for monitoring.
- When the **REC** button for TRACK 1 is unlit, you cannot hear the guitar sound that is being input.

## Recording a guitar to TRACK 1

1. Press the **RECORD** (**●**) button to start recording and play the guitar.  
The **REC** button for TRACK 1 stops flashing and lights steadily.
2. After you finish your performance, press the **STOP** (**■**) button to stop recording.  
The recorded file is saved in the folder of the currently loaded song.
3. Press the **REC** button for TRACK 1 so the **REC** button becomes unlit.

## 2 - Quick Guide

### Playing back the recording

1. To return to the beginning of the song (ZERO point), press and hold the **STOP** (■) button and press the **REW** (◀◀) (**TO ZERO**) button (TO ZERO function).
2. Press the **PLAY** (▶) button to play back the recording on TRACK 1.
3. Use the fader for TRACK 1 and the **STEREO** fader to adjust the playback monitoring level. Use the **MONITOR LEVEL** knob to adjust the final monitoring volume.

#### TIP

Use the **PAN** knob for TRACK 1 on the Mixer screen to set the stereo position of the track signal.

### Recording a guitar to TRACK 2

Now you should listen to the rhythm guitar on TRACK 1 and play the lead guitar on TRACK 2.

Follow the procedure below to change the recording source of the TRACK 2.

1. Press the **ASSIGN** button to open the Assign screen.

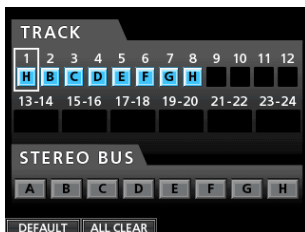

Record the lead guitar sound from INPUT H to TRACK 2. By default, INPUT B is assigned to TRACK 2.

2. Use the **CURSOR** (▲/▼/◀/▶) buttons or press the **SELECT** button for TRACK 2 and align the cursor (frame) on the Assign screen with TRACK 2.

Use the **JOG/DATA** dial or press the **SOURCE** button for INPUT H to set the recording source of the TRACK 2 to H.

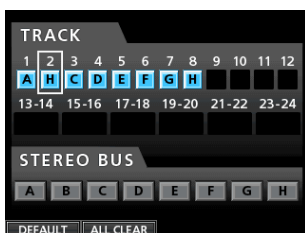

3. Press the **HOME** button to return to the Home screen.

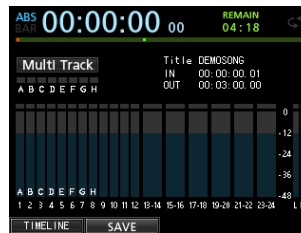

4. Press the **REC** button for TRACK 2.

Its **REC** indicator blinks and the unit enters record standby. When you play the guitar, the input level is shown by the level meter for 2 (TRACK 2).

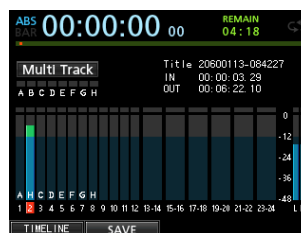

5. Return to the beginning of the song (ZERO point) and start playback of the recorded rhythm guitar to play the lead guitar part along with the recording.  
Raise the fader for TRACK 2 to hear both the playback of TRACK 1 and input guitar signal through your headphones.
6. As necessary, use the faders for TRACK 1 and 2, **PAN** knobs, **STEREO** fader and **MONITOR LEVEL** knob to adjust the monitoring level and balance.
7. Return to the beginning of the song, press the **RECORD** (●) button to start recording, and play the lead guitar part.  
The **RECORD** (●) button lights red, and the **REC** indicator for TRACK 2 stops flashing and becomes lit.
8. After you finish your performance, press the **STOP** (■) button to stop recording.  
The recorded file is saved in the folder of the currently loaded song.
9. Press the **REC** button for TRACK 2 so the **REC** button becomes unlit.

## Recording a vocal to TRACK 3

1. Press the **ASSIGN** button to open the Assign screen.

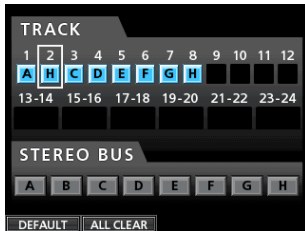

2. Use the **CURSOR** (▲/▼/◀/▶) buttons or press the **SELECT** button for TRACK 3 and align the cursor (frame) on the Assign screen with TRACK 3.

Use the **JOG/DATA** dial or press the **SOURCE** button for INPUT B to set the recording source of the TRACK 3 to B.

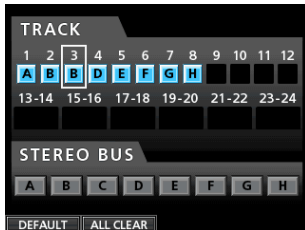

3. Press the **HOME** button to return to the Home screen.

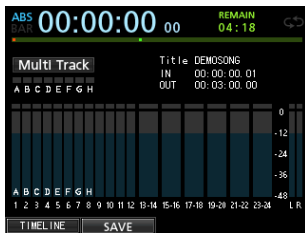

4. Press the **REC** button for TRACK 3.  
The **REC** indicator blinks and the unit enters record standby.
5. Use the TRIM knob for INPUT B to adjust the input level suitably for the mic. Set the TRIM knob so that the OL indicator for INPUT B does not light even when the loudest sound to be recorded is input.

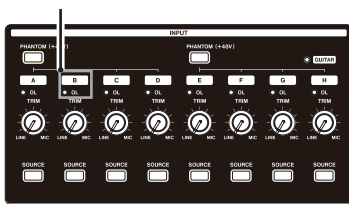

When you input a sound through an external microphone, the input level is shown by the **3** level meter.

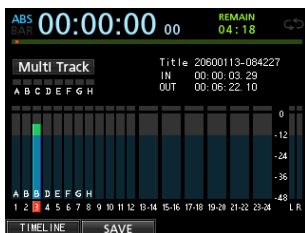

When you raise the fader for TRACK 3, the **STEREO** fader and the **MONITOR LEVEL** knob, you can hear the sound of the mic input through the headphones.

### NOTE

*If the OL indicator continues to light even when the TRIM knob is turned down, the mic signal itself is too loud. In this case, move the mic further away from the sound source or lower the volume of the sound source.*

6. Return to the beginning of the song, start playback of the recorded rhythm guitar and lead guitar parts, and sing along with the recording.  
You can hear the playback of the recorded guitar parts on tracks 1 and 2 along with the vocal on your headphones.
7. As necessary, use the faders for TRACK 1 and 2, **PAN** knobs, **STEREO** fader and **MONITOR LEVEL** knob to adjust the monitoring level and balance.
8. Return to the beginning of the song, press the **RECORD** (●) button to start recording, and then sing along with the recording.  
The **RECORD** (●) button lights red, and the **REC** indicator for TRACK 3 stops flashing and lights steadily.
9. After you finish your performance, press the **STOP** (■) button to stop recording.  
The recorded file is saved in the folder of the currently loaded song.
10. Press the **REC** button for TRACK 3 so that the **REC** button becomes unlit.

## 2 - Quick Guide

### Mixing the tracks

Once you have finished your recording, you are ready to mix down and create a master file.

1. Use the faders for TRACK 1 to 3 to adjust their balance of levels. Use the **STEREO** fader to adjust the overall level.
2. Press the **MIXER** button to open the Mixer screen.

Press the **SELECT** buttons for TRACK 1 to 3 to select the track to be set and then use the **PAN** knob to set its stereo position.

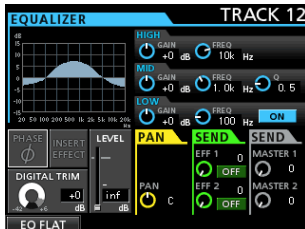

3. Set the IN point.  
The interval from the IN point to the OUT point will be used for the master file.  
Play back the song, press and hold the **MARK SET** button and press the **IN** button at the point where you want to start the master file.  
The position where you pressed the button is set as the IN point, which is where the mix down will start.

4. Set the OUT point.  
Play back the song, press and hold the **MARK SET** button and press the **OUT** button where you want to end the master file.  
The position where you pressed the button is set as the OUT point, which is where the mix down will end.

#### TIP

You can also press and hold the **MARK SET** button and press the **IN** or **OUT** button to set the IN and OUT points when playback is stopped.

5. Press the **MIXDOWN/MASTERING** button.  
The Recorder mode switches to Mixdown mode and the display returns to the Home screen.

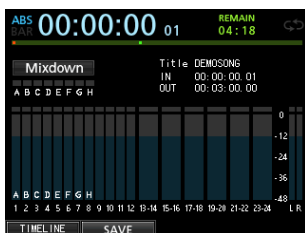

#### NOTE

In Mixdown mode, Mixdown appears on the upper left corner of the Home screen.

6. Press the **RECORD** (●) button.  
The master file recording starts.  
Recording stops automatically when the OUT point is reached.

#### NOTE

- The IN and OUT points must be at least 4 seconds apart. If the interval is shorter than 4 seconds, the message **I/O Too Short** will appear and the Recorder mode cannot switch to Mixdown mode.

- During recording, you can use the track faders to adjust the levels of the tracks and the overall level.
- You can also use the equalizer or reverb effect while recording a master file. (See "Track equalizer" on page 55 and "Send effects" on page 54.)
- You can mute unwanted tracks so that they are not recorded to the master file. (See "Muting tracks" on page 39.)

### Mastering a recording

You can adjust the master file to tailor the sound to your preference. This process is called mastering.

#### ■ Checking the master file

1. When Recorder mode is Mixdown mode, press the **MIXDOWN/MASTERING** button to open the **MASTERING** screen.

The Recorder mode switches to Mastering mode and the display returns to the Home screen.



#### NOTE

- In Mastering mode, Mastering appears on the upper left corner of the Home screen.
  - When a master file does not exist, the Recorder mode cannot switch to Mastering mode.
  - If Recorder mode is Multi Track mode, you can press the **MIXDOWN/MASTERING** button to switch to the Mixdown mode, and then press the **MIXDOWN/MASTERING** button again to switch to the Mastering mode.
2. In this mode, press the **PLAY** (▶) button to listen to the master file that you have created.

#### NOTE

- Confirm that both the EQ and COMP items are set to OFF. If either is set to ON, the sound heard will be affected by the equalizer and/or compressor. (See "Using the mastering equalizer" on page 59 and "Using mastering compression" on page 59.)
- In Mastering mode, the **STEREO** fader cannot be used to adjust the level.



### ■ Applying equalization

In this example, we will use the equalizer on the master file to reduce high frequencies and increase low frequencies slightly.

1. When Recorder mode is Mastering mode, press the **F1** (EQ) button to open the EQUALIZER screen.

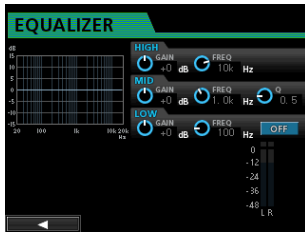

2. Turn the EQ HIGH knob to the left to lower the GAIN knob for HIGH shown on the screen. Set to "-2 dB". This reduces the high frequencies.
3. Next turn the EQ MID knob to the left to lower the GAIN for MID. Set to "-2 dB". This reduces the mid frequencies.
4. Next, turn the EQ LOW knob to the right to raise the GAIN knob for LOW shown on the screen. Set to "+6 dB". This increase the low frequencies.
5. Press the ON/OFF button on the right of the LOW knob to turn the equalizer on.

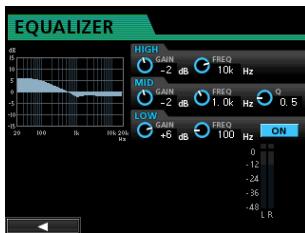

6. Press the **F1** (◀) button to return to the Mastering screen.
7. Now you can press the **PLAY** (▶) button to listen to the master file with equalization.

### ■ Applying compression

Use the compressor on the master file to adjust the impact of the entire song.

1. When Recorder mode is Mastering mode, press the **F2** (COMP) button to open the COMP MULTI screen.



2. Press the **F3** (LIBRARY) button to open the library list.



3. Use the **JOG/DATA** dial to select (blue highlight) an item from the list and then press the **F4** (▶) button to load the appropriate setting from the library.  
The library list closes.

#### TIP

*You can also adjust the parameters on the COMP MULTI screen using the CURSOR buttons and JOG/DATA dial.*

4. Press the **F4** (ON) button to turn the compressor on.  
The indication OFF changes to ON.



5. Press the **F1** (◀) button to return to the Mastering screen.
6. Press the **PLAY** (▶) button on the Mastering screen to listen to the master file with compression.

#### NOTE

*If the EQ item is set to ON on the EQUALIZER screen, the effect of the equalizer on the sound will also be heard.*

## 2 - Quick Guide

### ■ Normalizing

Normalizing maximizes the volume of the master file.

1. When Recorder mode is **Mastering** mode, press the **F4** (**NORM**) button to open the **NORMALIZE** screen.

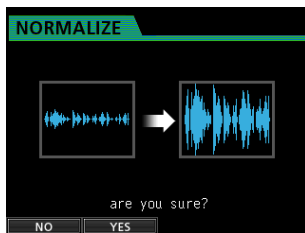

2. Press the **F2** (**YES**) button to perform the normalization.
3. Once the process is completed, the display returns to the Mastering screen.

### ■ Re-recording the master file

Re-record the master file with equalization and compression applied to create a new master file.

1. When Recorder mode is **Mastering** mode, press the **RECORD** (●) button.
2. This will record over the master file and create a new master file with equalization and compression applied.

## Shutting down

Turn the unit off when you are done using it.

1. Press the **HOME** button to open the Home screen.

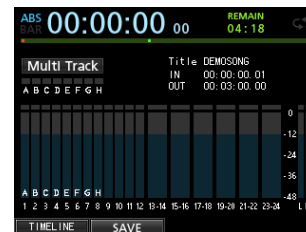

2. Press and hold the **STANDBY/ON** button on the rear panel until **PORTASTUDIO** appears on the display.

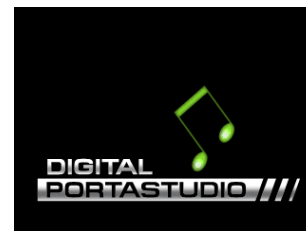

When the unit completes its automatic shutdown procedure, which includes recording various information about the operations that have been performed until now, the power turns off (standby).

Always use the procedure above to turn the power off properly.

### CAUTION

*When the power is on, do not cut the power to the unit by, for example disconnecting the power cord. All settings made since the last time you saved will not be saved. If you cut the power while an SD card is being accessed, all recorded songs and data may be damaged and cannot be recovered.*

# 3 – Names and Functions of Parts

## Top panel

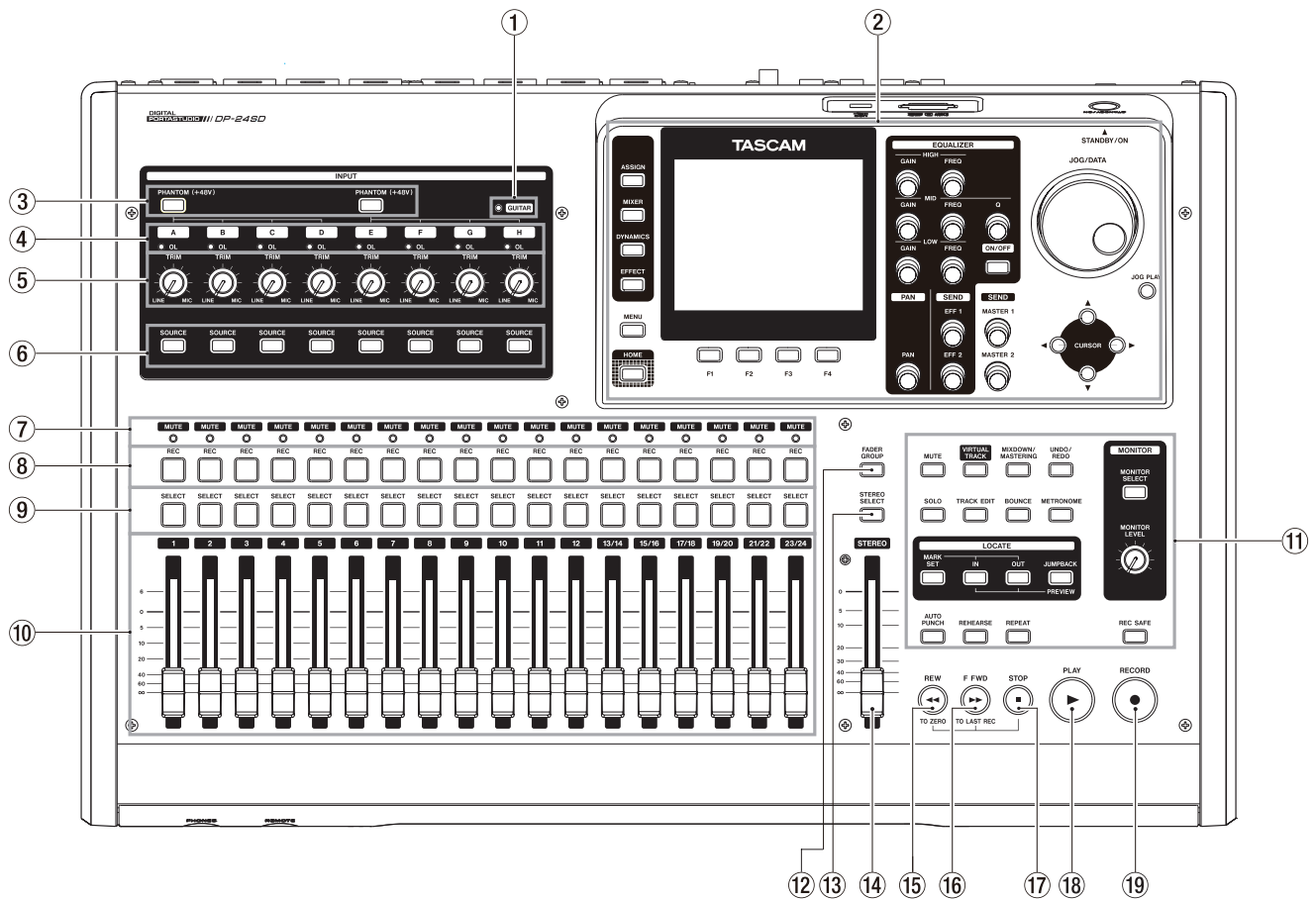

### 1 GUITAR indicator

This indicator lights when the **LINE-GUITAR** switch on the rear panel is set to **GUITAR**.

### 2 Display

Use the **JOG/DATA** dial or the **CURSOR** (▲/▼/◀/▶) buttons to return to the Home screen, to open the **MENU** screen, to assign input signals to tracks, to change parameters for each input or track, and to perform many other operations.

### 3 PHANTOM (+48V) button/indicator

Use this button to turn the phantom power on/off for the **MIC/LINE INPUT A-D** and **E-H** jacks on the rear panel.

The **PHANTOM** indicator lights when phantom power is turned on.

When the **GUITAR** indicator is lit, even if phantom (+48V) power is **ON** (indicator lit) for **E-H**, INPUT **H** will not receive phantom power.

## CAUTION

- Use the **STEREO** fader and **MONITOR LEVEL** knob to lower the output volume of the unit before turning phantom power on or off. Depending on the microphone, a loud noise could occur, damaging equipment and harming people's hearing.
- Do not connect or disconnect a microphone when phantom power is turned on. Doing so could cause a loud noise and might damage this unit and connected equipment.
- Turn phantom power on only when using a condenser microphone that requires phantom power. Turning phantom power on when a dynamic mic or other mic that

does not require it is connected could damage this unit and connected equipment.

- When using condenser mics that require phantom power and dynamic mics together, be sure to use balanced dynamic mics. Unbalanced dynamic mics cannot be used when phantom power is enabled.
  - Supplying phantom power to some ribbon mics will break them. If you are unsure, do not supply phantom power to a ribbon mic.
- ### 4 OL indicators (A-H)
- These indicators light when the input source signal is too loud.
- ### 5 TRIM knobs (A-H)
- Use these knobs to adjust the input levels. (See "Making the first recording" on page 39.)
- ### 6 SOURCE buttons/indicators
- When you press one of these buttons, the corresponding input (**INPUT A** to **H**) is selected (its button lights) as the input source.
- The mixer and other functions are applied to the selected input.
- These buttons are also used to assign an input source to a track (see "Assigning inputs" on page 35).
- ### 7 MUTE/SOLO indicators
- These indicators light when a track is muted or in Solo mode. When the **SOLO** button is not lit, it indicates the track is in Mute mode. When the **SOLO** button is lit, it indicates the track is in Solo mode.

## 3 – Names and Functions of Parts

### 8 REC buttons/indicators

Use these buttons to turn recording on/off for each track.

To monitor a track's input sound through headphones or a monitoring system, press the **REC** button for the corresponding track.

When the **REC** button is turned on, the **REC** button flashes when the recorder is stopped, and lights during recording.

### 9 SELECT buttons/indicators

When you press one of these buttons, the corresponding track (1 to 23/24) is selected (its button lights) as the current channel.

The mixer and other functions are applied to the current channel.

These buttons are also used for the following purposes.

- To assign an input source to a track (See "Assigning inputs" on page 35.)
- To assign effects to an input (See "Inserting a guitar effect" on page 53.)
- To select the group for FADER GROUP

### 10 TRACK faders (TRACK 1 to TRACK 23/24)

Use these faders to adjust the monitoring level of a track's playback signal or the input signal assigned to the track. (See "Levels and balance" on page 55.)

### 11 Operation buttons for various functions

Use these buttons to activate/deactivate functions or to perform the operation set to them.

### 12 FADER GROUP button/indicator

Press this button to set a fader group.

The button becomes lit. (See "Fader group" on page 55.)

### 13 STEREO SELECT button/indicator

When the Assign screen is displayed, you can press this button to move the cursor from the **TRACK** display to the **STEREO BUS** display, and set the input for the stereo bus. (See "Assigning to a stereo bus" on page 35.)

### 14 STEREO fader

Use this fader to adjust the stereo signal level output from the **STEREO OUT** jacks and **PHONES** jack. Use this fader also to adjust the recording level when bouncing or mixing down tracks.

### 15 REW (◀◀) (TO ZERO) button

When stopped or during playback, press and hold this button to rewind. Rewind is performed at a fixed 10x speed. Press briefly to jump to the previous mark.

Press and hold the **STOP (■)** button and press this button to locate the beginning of the song (00:00:00:00 = ZERO point). (See "Returning to zero or the last recording position" on page 44.)

### 16 F FWD (▶▶) (TO LAST REC) button

When stopped or during playback, press and hold this button to fast-forward. Fast-forward is performed at a fixed 10x speed.

Press briefly to jump to the next mark.

Press and hold the **STOP (■)** button and press this button to locate the last recording position (LAST REC point). (See "Returning to zero or the last recording position" on page 44.)

### 17 STOP (■) button

Use this button to stop playback, recording and fast-forward/rewind. Press at the same time as you press the **REW (◀◀) (TO ZERO)** button or **F FWD (▶▶) (TO LAST REC)** button to locate the beginning of the song

(00:00:00:00 = ZERO point) or the last recording position (LAST REC point). (See "Returning to zero or the last recording position" on page 44.)

### 18 PLAY (▶) button/indicator

Press this button to start playback.

During recording, press this button to stop recording and start playback (punch out).

During playback or recording, the **PLAY (▶)** button becomes lit.

### 19 RECORD (●) button/indicator

Press this button to start recording.

This button becomes lit during recording. During playback, if you press this button when a track **REC** button is flashing, recording to that track will begin (punch in). (See "Automatic punching in and out" on page 46.)

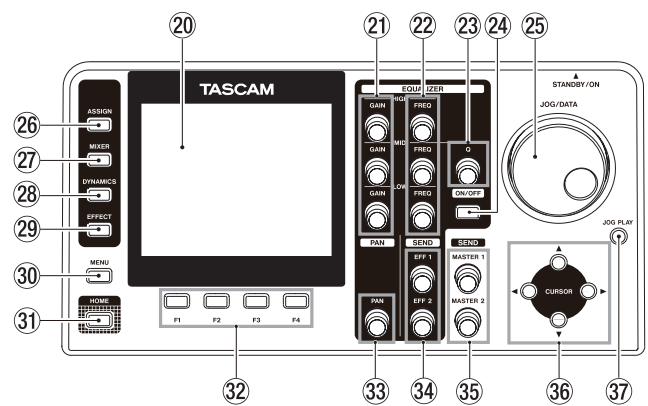

### 20 Color display

3.5-inch TFT LCD display with a resolution of 320x240 dots.

This display shows various types of information.

#### NOTE

*The display is produced with extremely high-precision manufacturing technologies. More than 99.99% of the pixels operate to specification. Less than 0.01% of the pixels may occasionally misfire or appear as red or black dots. This does not constitute a malfunction.*

### 21 GAIN (HIGH/MID/LOW) knobs

Use these knobs to adjust the equalizer gain. (See "Using the input equalizer" on page 37.)

### 22 FREQ (HIGH/MID/LOW) knobs

Use these knobs to adjust the center frequency of the equalizer. (See "Using the input equalizer" on page 37.)

### 23 Q knob

Use this knob to adjust the MID bandwidth of the equalizer. (See "Using the input equalizer" on page 37.)

### 24 EQUALIZER ON/OFF button

Use this button to turn the equalizer on and off. (See "Using the input equalizer" on page 37.)

### 25 JOG/DATA dial

When the Home screen is displayed, you can use this dial to perform transport jog operations. (See "Cueing with the JOG/DATA dial" on page 45.)

Use this dial to change parameter values and select items when using menus.

## 3 – Names and Functions of Parts

### 26 **ASSIGN button/indicator**

Use this button to set (assign) the input (INPUT A to H) for each track. When you press this button, the Assign screen opens. The input signal of the assigned input source becomes the recording source. (See “Assigning inputs” on page 35.)

### 27 **MIXER button/indicator**

Press this button to open the Mixer screen.

On this screen, you can adjust the settings for the inputs (INPUT A to H) or tracks (including GROUP) that are selected. (See “Bouncing tracks” on page 43.)

### 28 **DYNAMICS button/indicator**

Pressing this button opens a screen to adjust the settings for the effects applied to the inputs (INPUT A to H). (See “Dynamic effects” on page 53.)

### 29 **EFFECT button/indicator**

Pressing this button opens a screen to make adjustments in the effects. (See “Guitar effects” on page 53 and “Send effects” on page 54.)

### 30 **MENU button**

Press this button to open the MENU screen. (See “Menu structure” on page 24.)

### 31 **HOME button**

Press this button to open the Home screen. (See “Home screen” on page 23.)

### 32 **F1 to F4 (Function) buttons**

The functions of these buttons depend on the screen currently displayed. The functions currently assigned to the **F1** to **F4** buttons are shown at the bottom of the screen.

### 33 **PAN knob**

Use this knob to adjust the stereo position of the track's playback signal or the input signal assigned to that track. (See “Stereo position (panning)” on page 55.)

### 34 **SEND EFF 1/EFF 2 knobs**

Use these knobs to adjust the output of the **EFFECT SENDS** jacks.

You can also use the **SEND EFF 1** knob to adjust the internal effects. (See “Sending signals to internal/external effects” on page 38.)

### 35 **SEND MASTER 1/MASTER 2 knobs**

Use these knobs to adjust the output of the **EFFECT SENDS** jacks.

You can also use the **SEND MASTER 1** knob to adjust the internal effects. (See “Sending signals to internal/external effects” on page 38.)

### 36 **CURSOR (▲/▼/◀/▶) buttons**

Use these buttons to move the cursor on the screen.

### 37 **JOG PLAY button**

Press this button to switch to the Search mode.

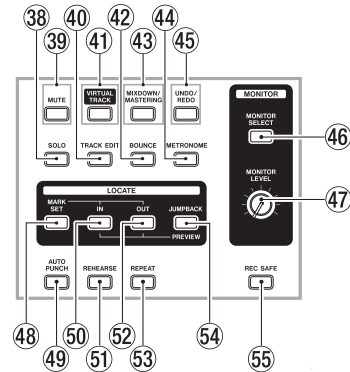

### 38 **SOLO button/indicator**

Press this button to switch to the Solo mode (the button lights). (See “Solo” on page 39.)

### 39 **MUTE button/indicator**

Press this button to switch to the Mute mode (the button lights). (See “Muting tracks” on page 39.)

### 40 **TRACK EDIT button**

Press this button to open the TRACK EDIT screen. (See “8 - Track Editing” on page 49.)

### 41 **VIRTUAL TRACK button/indicator**

The VIRTUAL TRACK screen appears. (See “Virtual tracks” on page 48.)

### 42 **BOUNCE button/indicator**

Press this button to switch to the Bounce mode (the button lights). (See “Bouncing tracks” on page 43.)

### 43 **MIXDOWN/MASTERING button/indicator**

Press this button to switch the Recorder mode among Multi Track, Mixdown and Mastering modes.

- In Multi Track mode, press this button to switch to the Mixdown mode.
- In Mixdown mode, press this button to switch to the Mastering mode when there is a master file, or press it to return to the Multi Track mode when there is no master file.
- In Mastering mode, press this button to return to the Multi Track mode.

### **NOTE**

*The current mode is displayed on the Home screen.*

### 44 **METRONOME button/indicator**

Press this button to set the metronome.

The button flashes according to the set tempo/beat. (See “Metronome” on page 61.)

### 45 **UNDO/REDO button/indicator**

Press this button to undo the immediately previous action (single undo) or cancel a single undo (redo). (See “Undoing an operation” on page 40.)

After a single undo or multi-undo, the **UNDO/REDO** button becomes lit, showing that an operation has been undone.

### 46 **MONITOR SELECT button**

Press this button to open the MONITOR SELECT pop-up window on the Home screen. (See “Monitor selection” on page 36.)

## 3 – Names and Functions of Parts

- ④⑦ **MONITOR LEVEL knob**  
Use this knob to adjust the output level of the output signals.
- ④⑧ **MARK SET button**  
During recording or playback, press this button to set a mark manually. (See “Location marks” on page 44.)
- ④⑨ **AUTO PUNCH button/indicator**  
Press this button to turn the auto punch mode on and off. When auto punch mode is turned on, **Auto Punch** is displayed on the Home screen. (See “Automatic punching in and out” on page 46.)
- ⑤⑩ **IN button**  
Press this button to locate the IN point.  
Press and hold the **MARK SET** button and press this button to set the IN point.  
Press and hold the **JUMPBACK (PREVIEW)** button and press this button to perform the pre-roll playback up to the current position and stop. (See “Checking cueing points (preview)” on page 46.)
- ⑤① **REHEARSE button/indicator**  
Use this button to turn the Rehearse mode on and off. In addition to auto punch in/out, you can also use the Rehearse mode for ordinary recording. (See “Rehearsing the recording” on page 39.)
- ⑤② **OUT button**  
Press this button to locate the OUT point.  
Press and hold the **MARK SET** button and press this button to set the OUT point.  
Press and hold the **JUMPBACK (PREVIEW)** button and press this button to perform the post-roll playback from the current position, return and stop. (See “Checking cueing points (preview)” on page 46.)
- ⑤③ **REPEAT button/indicator**  
Press to this button to turn Repeat Playback mode on and off. (See “Using repeat playback” on page 46.)
- ⑤④ **JUMPBACK (PREVIEW) button**  
Press this button to rewind the specified number of seconds from the current position and start playback. (See “Jumpback playback” on page 46.)
- ⑤⑤ **REC SAFE button**  
Press to disable recording on all tracks.

### Front panel

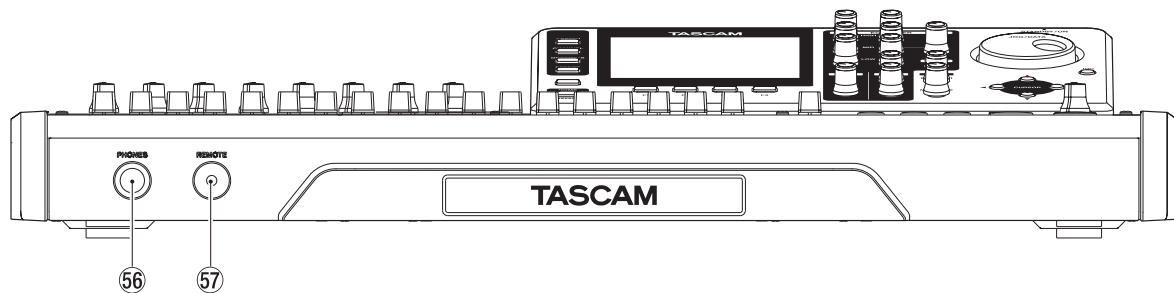

- ⑤⑥ **PHONES jack**  
Use this stereo standard jack to connect stereo headphones.  
Use the **MONITOR LEVEL** knob on the top panel to adjust the volume.

#### CAUTION

*Before connecting headphones, use the **MONITOR LEVEL** knob on the top panel to set to the volume to minimum. A loud noise could occur, resulting in damages to equipment and people's hearing.*

- ⑤⑦ **REMOTE jack (2.5mm dia. TRS jack)**  
Connect the TASCAM RC-3F foot switch (sold separately). This allows you to remotely control a variety of operations, including punch in/out (start and stop recording).

## 3 – Names and Functions of Parts

### Rear panel

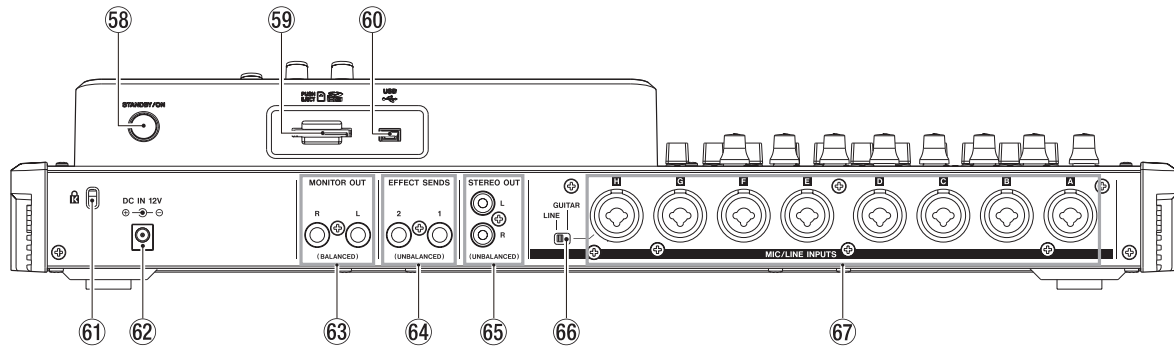

- 58 STANDBY/ON button**  
When the power is OFF (standby), press and hold this button to turn the power on. When power is ON, press and hold this button to turn the power off (standby). (See “Start-up & Shutdown” on page 27.)
- 59 SD card slot**  
Insert the SD card into this slot.
- 60 USB port**  
Use a commercially-available USB cable to connect with a computer USB port. (See “Connecting to a computer” on page 67.)

#### CAUTION

*Always connect the unit directly to a computer. Do not use a USB hub.*

- 61 Kensington lock attachment hole**
- 62 DC IN 12V jack**  
Connect the supplied PS-P1220E AC adapter.
- 63 MONITOR OUT jacks (standard balanced TRS jacks)**  
These jacks output the signal selected in the monitor section of the top panel. These are standard balanced phone jacks.
- 64 EFFECT SENDS jacks (standard unbalanced TS jacks)**  
These jacks output the signal from effect sends 1 and 2.
- 65 STEREO OUT jacks (unbalanced RCA jacks)**  
These jacks output the stereo bus signal.
- 66 LINE-GUITAR switch**  
You must set this switch according to the input source of the **MIC/LINE INPUTS H**. When connecting directly an electric guitar, electric bass or other similar instrument, set this switch to **GUITAR**. When connecting a digital instrument or an audio equipment, set it to **LINE**.
- 67 MIC/LINE INPUTS A-H jacks (balanced)**  
These are balanced analog XLR/TRS combo jacks for microphone and line inputs.
- XLR (1: GND, 2: HOT, 3: COLD)
  - TRS (Tip: HOT, Ring: COLD, Sleeve: GND)

### Home screen

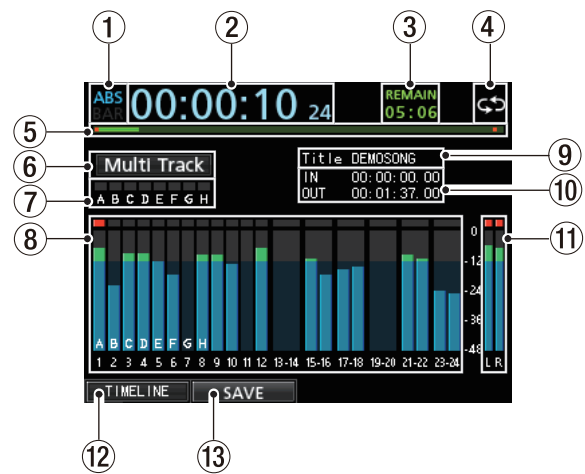

Home screen and track level meter display

- 1 Counter mode display**  
Displays the currently selected time counter mode: **ABS** or **BAR**.
- 2 Recorder time counter display**  
Displays the elapsed time from the start of the song.
- 3 REMAIN time display**  
Displays the remaining recordable time (Hours : Minutes) of the SD card.
- 4 Repeat playback**  
When the unit is in Repeat Playback mode, the icon appears.
- 5 Playback position display**  
Displays the current Playback position.
- 6 Recorder mode display**  
Displays the current Recorder mode.
- |             |                  |
|-------------|------------------|
| Multi Track | Multi Track mode |
| Bounce      | Bounce mode      |
| Mixdown     | Mixdown mode     |
| Mastering   | Mastering mode   |
- The following items are also displayed: Rehearsal, Auto Punch and Search.
- 7 INPUT A to H overload indicators**  
If the input signal of any **INPUT A to H** source is too loud, the corresponding indicators light.

## 3 – Names and Functions of Parts

- ⑧ **Track level meter**  
Displays input signal levels during recording and playback signal levels during playback.
- ⑨ **Song name display**  
Displays the song name during playback.
- ⑩ **IN/OUT point time display**  
Press and hold the **MARK SET** button and press the **IN** or **OUT** button to display the set IN or OUT point.
- ⑪ **Stereo level meter**  
Displays the signal level output from the **STEREO OUT** jacks.
- ⑫ **TIMELINE/METER display**  
When the level meter is displayed on the recorder track section of the Home screen, press the **F1 (TIMELINE)** button to change from level meter display to time line display.  
When the time line is displayed on the recorder track section of the Home screen, press the **F1 (METER)** to change from time line display to level meter display.

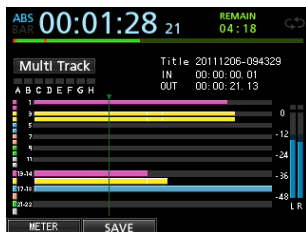

Timeline display on the Home screen

- ⑬ **SAVE display**  
Press the **F2 (SAVE)** button to open the **SONG SAVE** (Saving a song) pop-up window.

## Menu structure

Press the **MENU** button to open the **MENU** screen.  
The menu contains the following items.

Menu item	Function	Reference page
SONG	Performs song loading, saving and creation, and other song-related operations.	page 32
AUDIO DEPOT	Performs import and export of WAV files.	page 68
INFORMATION	Provides information about a song, file, and system.	page 64
TUNER	Performs the tuning of musical instruments.	page 62
USB	Performs USB settings.	page 67
FORMAT	Formats SD cards.	page 65
PREFERENCE	Setting the date and time	page 27
	Adjusting the contrast	page 29
	Peak hold display	page 37
	Using a foot switch to punch in/out	page 42
	jumpback playback	page 46
	Setting automatic power saving	page 63
	Setting automatic monitoring	page 63

You can also use dedicated buttons to open specific setting screens.

The menu contains the following items.

Button	Function	Reference page
<b>ASSIGN</b>	Assigns track sources to INPUT A to H.	page 35
<b>MIXER</b>	Displays the Mixer screen to make equalizer settings for tracks and inputs.	page 37, page 55
<b>DYNAMICS</b>	Assigns dynamic type effects such as compressor, etc., and makes parameters settings.	page 53
<b>EFFECT</b>	Assigns each type of effect and makes parameter settings.	page 53
<b>BOUNCE</b>	Performs track bouncing.	page 43
<b>MIXDOWN/MASTERING</b>	Creates and adjusts master files.	page 57
<b>METRONOME</b>	Sets the metronome.	page 61



# 3 – Names and Functions of Parts

## Screen operations

Use the **MENU** button and dedicated buttons to open screens, and then follow the guidelines below to use the functions on the screens.

These examples show basic operation procedures, but the actual assignments of the function buttons (**F1** to **F4** buttons) vary depending on the screen.

- Use the **JOG/DATA** dial or the **CURSOR** (▲/▼/◀/▶) buttons to select (green highlight) the desired item.



This example shows the **MENU** screen.  
The **SONG** menu item is selected on this screen.

### NOTE

#### About function buttons

The assignments of the function buttons (**F1** to **F4**) are shown at the bottom of the screen above the buttons themselves.

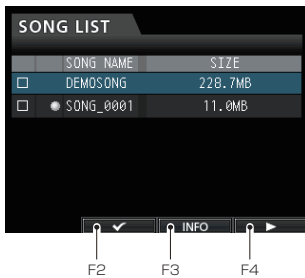

"✓" above the **F2** button shows that "✓" is assigned to the **F2** button when using this screen.

In this manual, the function assigned to a function button is described as **F2 (✓)** button, for example.

In this way, "INFO" is assigned to the **F3** button, and "▶" is assigned to the **F4** button.

- When an item has a sub-menu, "▶" appears on its right side, and the **F4** (▶) button is used to open it.
- On the sub-menu, you can press the **F1** (◀) button to return to the previous screen.



This example shows the **LOAD** screen.

On the sub-menu, use the **JOG/DATA** dial or the **CURSOR** (▲/▼) buttons to select **LOAD**, and then press the **F4** (▶) button to load the song.

- When the cursor (blue highlight) is on a setting value, use the **JOG/DATA** dial to change the value.  
To select an item, use the **CURSOR** (▲/▼) buttons.

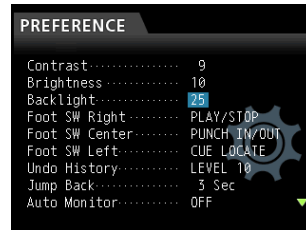

This example shows the **PREFERENCE** screen.

Use the **JOG/DATA** dial to change the value.

Move the cursor (blue highlight) up or down.

- When you have to move left or right, use the **CURSOR** (◀/▶) buttons.

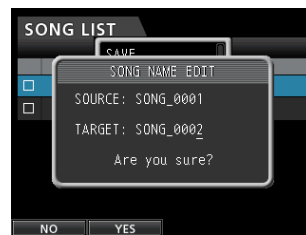

- Press the **HOME** button to return to the Home Screen.

# 4 – Preparation

## Inserting and removing SD cards

### Inserting an SD card

Insert the SD card into the SD card slot on the rear panel as shown in the illustration until it clicks into place.

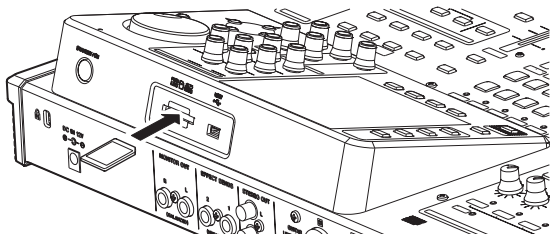

#### NOTE

An SD card is installed in the SD card slot when the unit is shipped from the factory. If you want to use this card to record and play tracks, there is no need to reinstall it.

### Removing the card

Push the loaded card in gently to eject it.

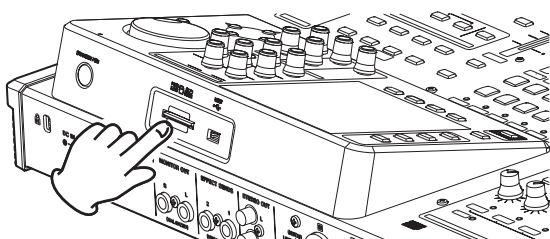

#### CAUTION

- Always turn the power off (standby) before removing an SD card. If you remove or insert an SD card when the power is on, recorded data may be lost and cannot be recovered.
- SD and SDHC cards that are at least 512 MB in size can be used.
- A list of SD cards that have been confirmed to work with this unit can be found on the TEAC Global Site (<http://teac-global.com/>).

## About write-protected SD cards

SD cards have write-protect (lock) switches.

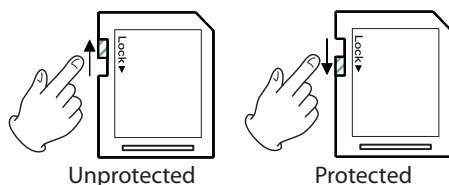

When the protect switch is in the LOCK position, files cannot be recorded or edited on the card. Slide the switch away from the LOCK position if you want to record, erase or otherwise change files on a card.

## Powering the unit

As shown in the illustration, connect the included PS-P1220E AC adapter to the DC IN 12V jack.

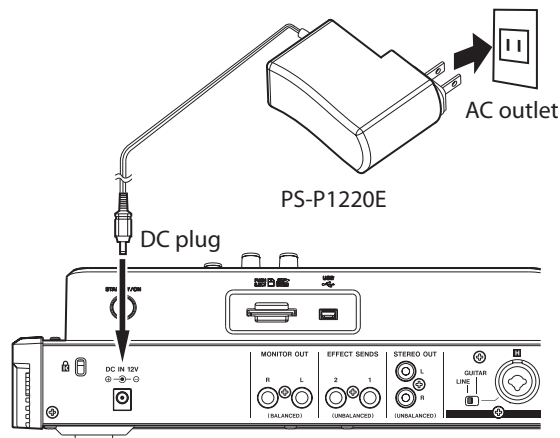

#### CAUTION

- Use only the included PS-P1220E AC adapter and power cord. Use of a different AC adapter could cause malfunction, fire or electric shock.
- Be sure to use the included PS-P1220E AC adapter to supply power to this unit. Power cannot be supplied to this unit via USB.

#### NOTE

The AC adapter for the unit includes two types of outlet plugs. Attach the type of plug that matches the power outlet that you are using.

## Changing the outlet plug

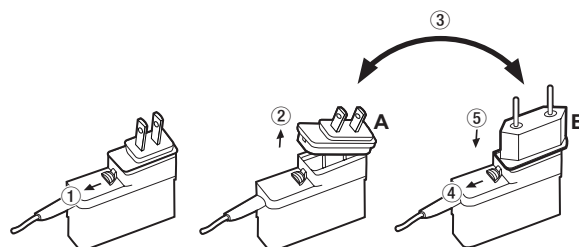

- ① Move the latch on the AC adapter in the direction of the arrow.
  - ② Pull off the outlet plug.
  - ③ Replace it with the other outlet plug (A or B).
  - ④ Move the latch on the AC adapter in the direction of the arrow again.
  - ⑤ Attach the outlet plug to the AC adapter.
- This completes changing the outlet plug.

After changing the outlet plug, confirm that it is not loose or crooked and that everything is normal before plugging it into an outlet.

#### CAUTION

Do not use the adapter if there is anything abnormal about the plug after changing it. Use when the plug is abnormal could cause fire or electric shock. Contact the store where you purchased this unit or a TASCAM customer support service to request repair.

## Start-up & Shutdown

### CAUTION

- Turn down the volume of the sound monitoring system connected to the unit before starting up or shutting down the unit.
- Do not use headphones when starting up or shutting down the unit. Otherwise, a large noise would cause damage to headphones or your ears.

### Starting up the unit

Press and hold the **STANDBY/ON** button on the rear panel for a few seconds.

When the unit starts, the startup screen appears briefly followed by the Home screen.



Start-up screen



Home screen

When the unit starts up, it defaults to Multi Track mode of the Recorder mode, regardless of the mode used last before shutting down.

### Shutting down

Make the following preparations before shutting down the unit.

- Stop the recorder. (The unit cannot be shut down during a recording and other procedures.)
- Return to the Home screen.
- If the unit is connected to a computer, disconnect the USB cable after performing the necessary procedure on the computer to disconnect the unit.

After making these preparations, press and hold the **STANDBY/ON** button on the rear panel until the following screen appears.



The power is turned off (standby) after the unit completes its shutdown process, including saving various information from your session.

### CAUTION

When the power is on, do not cut the power to the unit by, for example disconnecting the power cord. All settings made since the last time you saved will not be saved. If you cut the power while an SD card is being accessed, all recorded songs and data may be damaged and cannot be recovered.

### NOTE

When the power is turned off (standby), the currently loaded song is saved. When the power is turned on again, the last song used is reloaded in the same state it was when the power was turned off (standby). You can even undo and redo previous operations.

## Setting the date and time

Using its internal clock, this unit remembers the date and time when a song or file is recorded.

1. When the recorder is stopped, press the **MENU** button to open the MENU screen.
2. Use the **JOG/DATA** dial or the **CURSOR** (**▲/▼/◀/▶**) buttons to select (green highlight) **PREFERENCE**, and then press the **F4** (**▶**) button. The **PREFERENCE** screen appears.
3. Use the **CURSOR** (**▲/▼**) buttons to select (blue highlight) **Date/Time**, and then press the **F4** (**▶**) button.

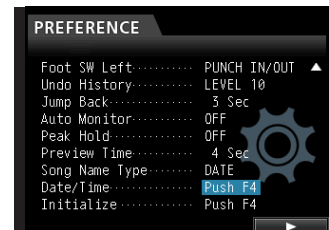

The **DATE/TIME** screen appears.

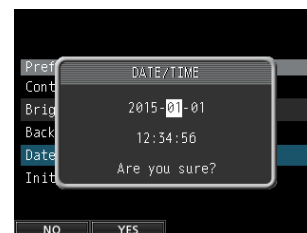

4. Use the **CURSOR** (**◀/▶**) buttons to move the cursor (blue highlight) to the desired item, and then use the **JOG/DATA** dial to change the value.
5. After making the settings, press the **F2** (**YES**) button to return to the Home screen.

### NOTE

- The time indication stops while time being set.
- You can automatically add the date you have set to file names by specifying **Song Name Type** on the **PREFERENCE** menu.

# 4 – Preparation

## Preparing an SD card for use

In order to use an SD card in this unit, you must format it first.

### CAUTION

*The included SD card is already formatted, so formatting it is not necessary. Formatting the supplied SD card erases the demo song previously stored.*

1. Confirm that the SD card is loaded and turn the power on.
2. A pop-up message "Invalid Card" appears when a new SD card or an SD card formatted for use with another device is installed in the unit.
3. You can also reformat a card in this unit at any time. (See "Quick formatting an SD card" on page 65 and "Full formatting an SD card" on page 66.)

To clear the pop-up message, press the **F1** button.

## Recorder modes

This unit has four recorder modes.

### Multi Track

Use this mode to operate the unit as a multitrack recorder.

### Bounce

Use this mode to perform track bouncing. (See "Bouncing tracks" on page 43.)

### Mixdown

Use this mode to mix down tracks to create a master file. (See "Mixing down tracks" on page 55 and "Creating a master file" on page 56.)

### Mastering

Use this mode to play back the master files that you have created and apply effects and tailor them to suit your preferences (mastering). (See "Checking the master file" on page 57 and "Finishing up a master file (mastering)" on page 58.)

When the unit starts up, it defaults to **Multi Track** mode of the Recorder mode, regardless of the mode used last before shutting down.

When Recorder mode is any mode other than **Multi Track** mode, many of the usual operations using the screen are unavailable.

In this manual, the **Multi Track** mode is the Recorder mode explained unless otherwise noted.

## Connecting other equipment

This section shows examples of how to connect other devices to this unit.

### Precautions before making connections

- Turn off (standby) this unit and all devices that you will connect beforehand.
- Supply power to all the devices from the same line. When using a power strip, for example, use one with a cable that has a high electric current capacity in order to minimize power voltage variations.

## Front panel

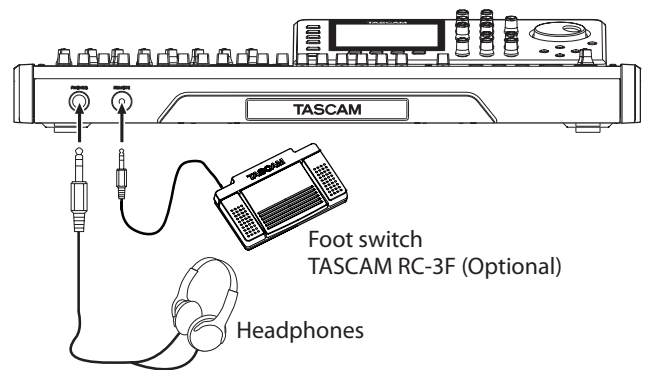

## Rear panel

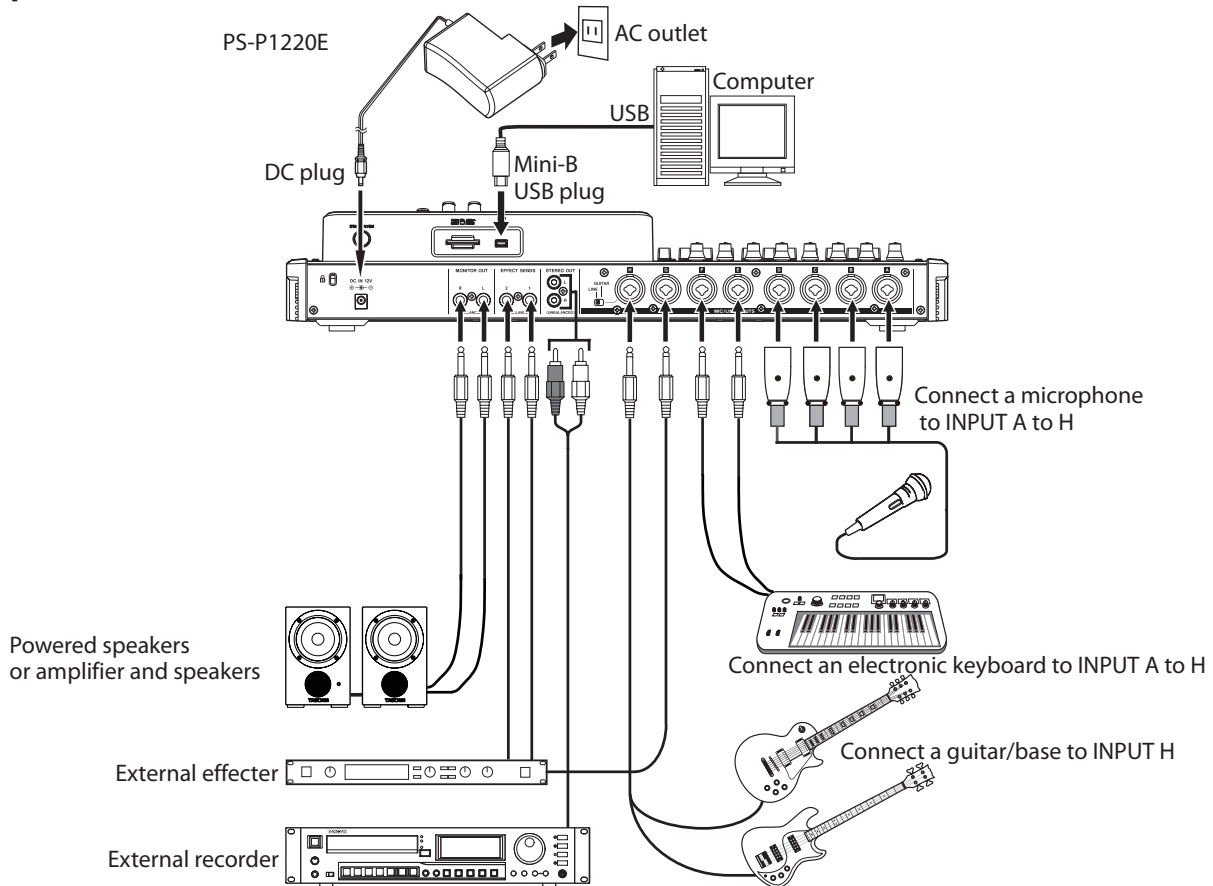

### CAUTION

- Use the **STEREO** fader and **MONITOR LEVEL** knob to lower the output volume of the unit before turning phantom power on or off. Depending on the microphone, a loud noise could occur, damaging equipment and harming people's hearing.
- Do not connect or disconnect a microphone when phantom power is turned on. Doing so could cause a loud noise and might damage this unit and connected equipment.
- Turn phantom power on only when using a condenser microphone that requires phantom power. Turning phantom power on when a dynamic mic or other mic that does not require it is connected could damage this unit and connected equipment.
- When using condenser mics that require phantom power and dynamic mics together, be sure to use balanced dynamic mics. Unbalanced dynamic mics cannot be used when phantom power is enabled.
- Supplying phantom power to some ribbon mics will break them. If you are unsure, do not supply phantom power to a ribbon mic.

### NOTE

- Before producing any sound, minimize the output volume using the **MONITOR LEVEL** knob and external monitoring system. A loud noise could occur, resulting in damages to equipment and people's hearing.
- Recorder functions cannot be used when the unit is connected to a computer via USB.

### TIP

When connecting an electric-acoustic guitar with a built-in preamp or an active-type electric guitar, or when using an

effects pedal, for example, between the guitar and this unit, set in the **LINE-GUITAR** switch on the rear panel to **LINE**.

## Adjusting the contrast

You can adjust the contrast of the display.

Follow the procedure below to adjust the contrast.

1. When the recorder is stopped, press the **MENU** button to open the **MENU** screen.
2. Use the **JOG/DATA** dial or the **CURSOR** (▲/▼/◀/▶) buttons to select (green highlight) **PREFERENCE**, and then press the **F4** (▶) button.

The **PREFERENCE** screen appears.

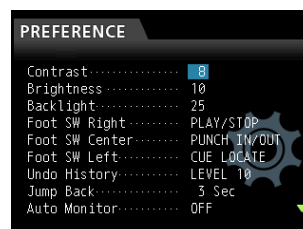

3. Use the **CURSOR** (▲/▼) buttons to select the items you want to adjust such as **Contrast**, **Brightness** and **Backlight**, and then use the **JOG/DATA** dial to make the adjustments.
4. After making the settings, press the **HOME** button to return to the Home screen.

# 5 - Song Management

This unit manages data in units called "songs". Ordinarily, each project should have its own "song" file. The first step is to load the song that you want to manage (load an existing song or create a new song).

In a song, the audio data for the recorded multitrack (TRACK 1 to 24) and the master file are saved.

This chapter covers basic operations, including procedures for loading songs and creating new songs, as well as explains various song management functions.

## Editing names

You can edit names on the following screens.

### When creating, saving or editing the name of a song

SONG CREATE pop-up window, SONG SAVE pop-up window, SONG NAME EDIT pop-up window, SONG COPY pop-up window

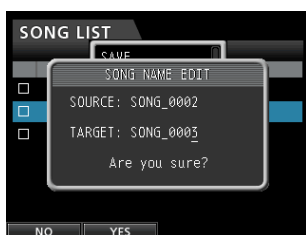

Follow the procedure below to edit names.

- Use the **CURSOR** (◀/▶) buttons to move the cursor (underline). The character at the cursor position (underline) is the one that can be edited.
- Use the **JOG/DATA** dial to change the characters at the cursor (underline) position. You can input a maximum of 15 characters, including ordinary symbols, numerals and English upper and lowercase letters.
- After inputting or editing, press the **F2** (YES) button to save the edited name.

## Loading a song

Follow the procedure below to load the song you want.

1. When the recorder is stopped, press the **MENU** button to open the MENU screen.
2. Use the **JOG/DATA** dial or the **CURSOR** (▲/▼/◀/▶) buttons to select (green highlight) **SONG**, and then press the **F4** (▶) button.

The **SONG LIST** screen appears.

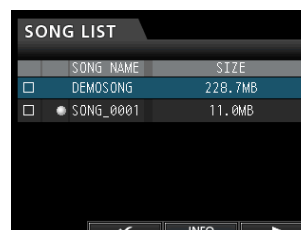

### NOTE

The ● icon appears next to the the currently loaded song. A lock icon 🔒 appears to the left of songs that are protected.

3. Use the **JOG/DATA** dial or the **CURSOR** (▲/▼) buttons to select the desired song, and then press the **F4** (▶) button to open the corresponding sub-menu.

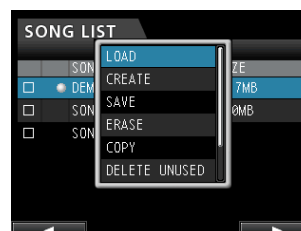

Use the **JOG/DATA** dial or the **CURSOR** (▲/▼) buttons to select **LOAD**, and then press the **F4** (▶) button again.

4. The **SONG LOAD** pop-up window appears.

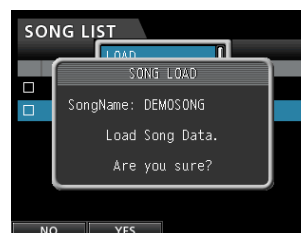

5. Press the **F2** (YES) button to load the selected song.

### NOTE

If you press the **F1** (NO) button, the pop-up window disappears and the display returns to the **SONG LIST** screen.

6. Once the song is loaded, the pop-up window disappears and the display returns to the **SONG LIST** screen.
7. Press the **HOME** button to return to the Home screen.

## Creating a new song

Follow the procedure below to create a new song.

1. When the recorder is stopped, press the **MENU** button to open the **MENU** screen.
2. Use the **JOG/DATA** dial or the **CURSOR** (**▲/▼/◀/▶**) buttons to select (green highlight) **SONG**, and then press the **F4** (**▶**) button.

The **SONG LIST** screen appears.

3. Press the **F4** (**▶**) button to open the corresponding sub-menu.

Use the **JOG/DATA** dial or the **CURSOR** (**▲/▼**) buttons to select **CREATE** from the sub-menu, and then press the **F4** (**▶**) button.



4. Press the **F4** (**▶**) button to open the **SONG CREATE** pop-up window.



The created song is given the name depending on the setting of **Song Name Type** on the **PREFERENCE** menu.

5. Change the song name in the **Name** item if you want. (See "Editing names" on page 30.)

### TIP

*You can edit the name of a song later selecting **NAME EDIT** from the **SONG** screen. You can also edit the song name when saving the song.*

6. Align the cursor with **Bit**, and turn the **JOG/DATA** dial to set the bit rate. (Default: 16bit)
7. Align the cursor with **Hz** and turn the **JOG/DATA** dial to set the sampling frequency. (Default: 44.1kHz)
8. Press the **F2** (**YES**) button to save the currently loaded song and create a new song.

### NOTE

*If you press the **F1** (**NO**) button, the pop-up window disappears and the display returns to the **SONG LIST** screen.*

9. Once the song is created, the pop-up window disappears and the display returns to the **SONG LIST** screen.
10. Press the **HOME** button to return to the Home screen.

## Saving a song

This unit automatically saves the current song during shutdown and when loading another song. You can also save a song at any time using the procedure below.

1. When the recorder is stopped, press the **MENU** button to open the **MENU** screen.
2. Use the **JOG/DATA** dial or the **CURSOR** (**▲/▼/◀/▶**) buttons to select (green highlight) **SONG**, and then press the **F4** (**▶**) button.

The **SONG LIST** screen appears.

3. Press the **F4** (**▶**) button to open the corresponding sub-menu.

Use the **JOG/DATA** dial or the **CURSOR** (**▲/▼**) buttons to select **SAVE** from the sub-menu, and then press the **F4** (**▶**) button.



4. Press the **F4** (**▶**) button to open the **SONG SAVE** pop-up window.

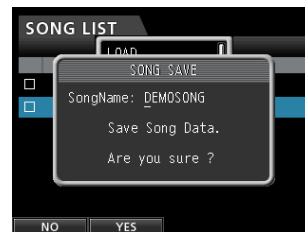

5. Change the song name in the **SongName** item if you want. (See "Editing names" on page 30.)

To save without changing the name, just press the **F2** (**YES**) button.

6. Once the song is saved, the pop-up window disappears and the display returns to the **SONG LIST** screen.
7. Press the **HOME** button to return to the Home screen.

### TIP

*The **SAVE** item, which is one of the **SONG LIST** sub-menus, can also be selected through the **F2** (**SAVE**) button on the Home screen.*

# 5 - Song Management

## Viewing song information

You can check the song file format, song name (title), time/date, and song size.

1. Press the **MENU** button to open the MENU screen.
2. Use the **JOG/DATA** dial or the **CURSOR** (**▲/▼/◀/▶**) buttons to select (green highlight) **SONG**, and then press the **F4** (**▶**) button.

The **SONG LIST** screen appears.

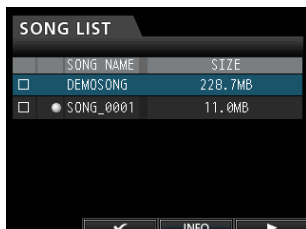

3. Press the **F3** (**INFO**) button to show a song information which appears in the following order: **SIZE**, **SAMPLE RATE**, **SAMPLE BIT**, and **DATE**.

## Copying songs

You can copy songs.

1. When the recorder is stopped, press the **MENU** button to open the MENU screen.
2. Use the **JOG/DATA** dial or the **CURSOR** (**▲/▼/◀/▶**) buttons to select (green highlight) **SONG**, and then press the **F4** (**▶**) button.

The **SONG LIST** screen appears.

3. Select (blue highlight) a song you want to copy.

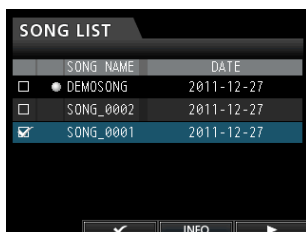

4. Next, press the **F4** (**▶**) button to open the corresponding sub-menu. Use the **JOG/DATA** dial or the **CURSOR** (**▲/▼**) buttons to select the item **COPY** from the sub-menu, and then press the **F4** (**▶**) button.

A pop-up message appears asking you to confirm the copy.

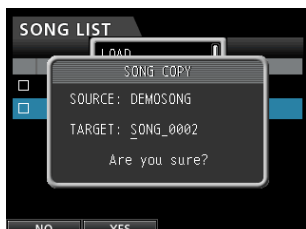

5. Change the song name as you want and press the **F2** (**YES**) button.

### NOTE

*To cancel the song copy operation, press the **F1** (**NO**) button instead of the **F2** (**YES**) button.*

6. When the song copy operation is completed, the pop-up window disappears and the display returns to the **SONG LIST** screen.

## Erasing songs

You can erase songs. You can also erase multiple songs at once. You might want to erase unneeded songs if the SD card starts to run out of space.

1. When the recorder is stopped, press the **MENU** button to open the MENU screen.
2. Use the **JOG/DATA** dial or the **CURSOR** (**▲/▼/◀/▶**) buttons to select (green highlight) **SONG**, and then press the **F4** (**▶**) button.

The **SONG LIST** screen appears.

3. Select (blue highlight) the song you want to erase and then press the **F2** (**✓**) button. To erase multiple songs, select all songs you want to erase.



### NOTE

*To remove the check mark ✓ from a check box, press the **F2** (**✓**) button again while the song is selected (blue highlight).*

4. Next, press the **F4** (**▶**) button to open the corresponding sub-menu. Use the **JOG/DATA** dial or the **CURSOR** (**▲/▼**) buttons to select the item **ERASE** from the sub-menu, and then press the **F4** (**▶**) button.

A pop-up message appears asking you to confirm the erase.

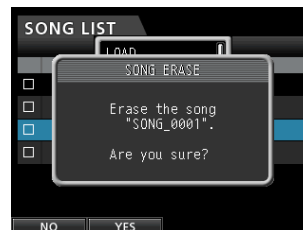

5. Press the **F2** (**YES**) button to perform the erase.

### NOTE

*To cancel the song erase operation, press the **F1** (**NO**) button instead of the **F2** (**YES**) button.*

6. When the song erase operation is completed, the pop-up window disappears and the display returns to the **SONG LIST** screen.

### NOTE

*The **MUSIC** folder must always have at least one song stored. Therefore, one song will be automatically created when you insert or format a card.*



## Protecting songs

If you protect a song, editing, recording and erasing of that song is prevented.

1. When the recorder is stopped, press the **MENU** button to open the **MENU** screen.
2. Use the **JOG/DATA** dial or the **CURSOR** (**▲/▼/◀/▶**) buttons to select (green highlight) **SONG**, and then press the **F4** (**▶**) button.

The **SONG LIST** screen appears.

3. Select the (blue highlight) song you want to protect and then press the **F2** (**✓**) button. To protect multiple songs, select all songs you want to protect.

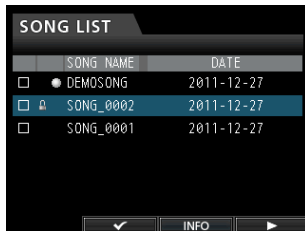

### NOTE

To remove the check mark **✓** from a check box, press the **F2** (**✓**) button again while the song is selected (blue highlight).

4. Next, press the **F4** (**▶**) button to open the corresponding sub-menu. Use the **JOG/DATA** dial or the **CURSOR** (**▲/▼**) buttons to select the **PROTECT** item from the sub-menu, and then press the **F4** (**▶**) button.

The song protect function is enabled for the selected song.

5. When the song protect operation is completed, the pop-up window disappears and the display returns to the **SONG LIST** screen.

### NOTE

- In a song list used to copy, erase or perform other functions, a lock icon **🔒** will appear next to protected songs.
- If you try to perform a prohibited operation (edit, record, erase) on a protected song, a Song Protected message will appear and the operation will be canceled.
- To remove the protection from a song, follow the same procedure above.

## Deleting unnecessary audio data from a song

In addition to audio data for a track, a song may also contain "unused" audio data.

When a track is overwritten in this unit, the overwritten audio data is not erased, but remains on the SD card. Audio data that has been completely overwritten is "unused" audio data.

You can delete such "unused" audio data by following the procedure below.

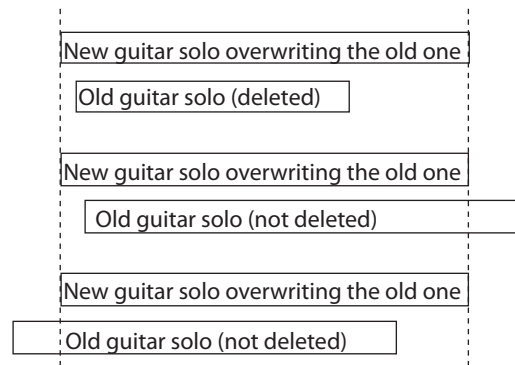

As shown in the illustration, if old audio data is not completely overwritten by new audio data, old audio data cannot be deleted.

"Unused" old audio data in any virtual track that has not been assigned to a physical track can also be deleted. (See "Virtual tracks" on page 48.)

Follow the procedure below to delete "unused" audio data and create room on the SD card for additional storage (this operation cannot be undone).

1. When the recorder is stopped, press the **MENU** button to open the **MENU** screen.
2. Use the **JOG/DATA** dial or the **CURSOR** (**▲/▼/◀/▶**) buttons to select (green highlight) **SONG**, and then press the **F4** (**▶**) button.  
The **SONG LIST** screen appears.
3. Select (blue highlight) the song which contains unnecessary audio data and then press the **F2** (**✓**) button. To erase multiple songs, select all songs you want to erase.

### NOTE

To remove the check mark **✓** from a check box, press the **F2** (**✓**) button again while the song is selected (blue highlight).

4. Next, press the **F4** (**▶**) button to open the corresponding sub-menu. Use the **JOG/DATA** dial or the **CURSOR** (**▲/▼**) buttons to select the item **DELETE UNUSED** from the sub-menu, and then press the **F4** (**▶**) button.

A confirmation message appears.

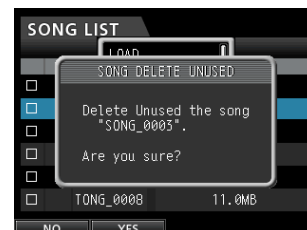

5. Press the **F2** (**YES**) button.

The unnecessary audio data is deleted from the song(s).

When the erase operation is completed, the pop-up window disappears and the display returns to the **SONG LIST** screen.

# 5 - Song Management

## NOTE

To cancel the unused audio data erase operation, press the **F1 (NO)** button instead of the **F2 (YES)** button.

## CAUTION

This operation deletes all unused audio data from the selected songs and cannot be undone. Therefore, if you think you use this audio data later, back up the data to a computer before executing the **DELETE UNUSED** item. (See "Connecting to a computer" on page 67.)

## Changing a song name

1. When the recorder is stopped, press the **MENU** button to open the **MENU** screen.
2. Use the **JOG/DATA** dial or the **CURSOR** (**▲/▼/◀/▶**) buttons to select (green highlight) **SONG**, and then press the **F4 (▶)** button.  
The **SONG LIST** screen appears.
3. Select (blue highlight) a song you want to change the name.

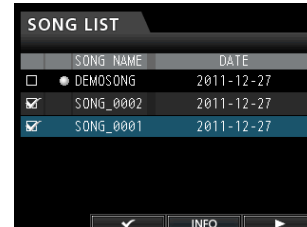

4. Next, press the **F4 (▶)** button to open the corresponding sub-menu. Use the **JOG/DATA** dial or the **CURSOR** (**▲/▼**) buttons to select the item **NAME EDIT** from the sub-menu, and then press the **F4 (▶)** button.  
Now you can change the song name.

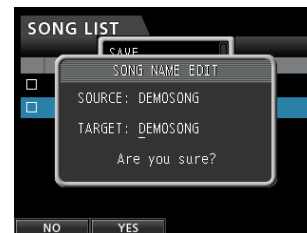

5. Change the song name as you want and press the **F2 (YES)** button.

## NOTE

To cancel the song name change, press the **F1 (NO)** button instead of the **F2 (YES)** button.

6. Once the song name is changed, the pop-up window disappears and the display returns to the **SONG LIST** screen.

# 6 - Basic Recording

## Selecting the input sources

This unit is equipped with eight inputs (**INPUT A** to **H**), and each of them has a standard XLR/TRS combo jack.

In addition to mic and line signals, you can connect a guitar to the **INPUT H** standard jack. When connecting a guitar, set the **LINE-GUITAR** switch on the rear panel to **GUITAR**.

### TIP

*When connecting an electric-acoustic guitar with a built-in preamp or an active-type electric guitar, or when using an effects pedal, for example, between the guitar and this unit, set the **LINE-GUITAR** switch on the rear panel to **LINE**.*

## Assigning inputs

When using this unit, "assigning inputs" means setting the recording source for each track to **INPUT A** to **H** on the Assign screen.

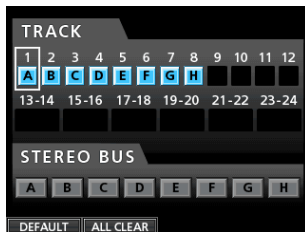

Assign screen

### NOTE

- In the initial settings, the recording sources of the track 1 to 8 are assigned to the inputs A to H (**INPUT A** to **H**), in that order.
- The assignment settings are saved when you save a song or turn the unit off. Likewise, the assignments settings are loaded when you load a song.

This unit can simultaneously record a maximum of eight tracks. You can assign one input source to multiple tracks simultaneously. However, you cannot assign multiple input sources to the same track. You can also assign an input source to a stereo bus.

## Assigning to a mono track

Tracks 1 to 12 are mono tracks.

1. When the recorder is stopped, press the **ASSIGN** button to open the Assign screen.
2. Use the **SELECT** button of each track or the **CURSOR** (**▲/▼/◀/▶**) buttons to move the cursor to the mono track you want to assign a recording source.
3. Press the **SOURCE** button of the desired input (INPUT A to H) or turn the **JOG/DATA** dial to set the input source of each mono track.
4. After making the settings, press the **ASSIGN** button or the **HOME** button to return to the Home screen.

## Assigning to a stereo track

Tracks **13/14** to **23/24** are stereo tracks.

Stereo tracks are always simultaneously recorded.

You cannot record to a single track of a stereo track pair.

1. When the recorder is stopped, press the **ASSIGN** button to open the Assign screen.

2. Use the **SELECT** button of each track or the **CURSOR** (**▲/▼/◀/▶**) buttons to move the cursor to the stereo track you want to assign a recording source.
3. Press the **SOURCE** button of the desired input (INPUT A to H) or turn the **JOG/DATA** dial to set the input source of each stereo track.

**Options:** A/A, A/B, B/B, C/C, C/D, D/D, E/E, E/F, F/F, G/G, G/H, and H/H

4. After making the settings, press the **ASSIGN** button or the **HOME** button to return to the Home screen.

### NOTE

- You can assign a single input source to multiple tracks by keeping the **SOURCE** button of the desired input (INPUT A to H) pressed and pressing the **SELECT** buttons of multiple tracks.
- However, you cannot assign multiple input sources to the same track.

## Assigning to a stereo bus

To use an external effect device, assign the inputs (**A** to **H**) that are connected to the outputs of the effect (EFFECT RETURN) to a stereo bus to return the effect signal to that stereo bus. You can also assign inputs to stereo buses during mixdown, allowing you to mix up to 8 input signals with the playback tracks.

1. When the recorder is stopped, press the **ASSIGN** button to open the Assign screen.
2. Use the **STEREO SELECT** button or the **CURSOR** (**▲/▼/◀/▶**) buttons to move the cursor to the **STEREO BUS** display area.
3. Use the **CURSOR** (**◀/▶**) buttons to move the cursor to the input source you want assign to the stereo bus.
4. Press the **SOURCE** button of the desired input (INPUT A to H) or turn the **JOG/DATA** dial to set the input source to the stereo bus.
5. After making the settings, press the **ASSIGN** button or the **HOME** button to return to the Home screen.

## Checking the assignment

You can check the current assignment on the Assign screen.

The assigned input source name (A to H) is displayed on the level meter display area of each track on the Home screen.

### NOTE

*When power is turned off (except when the song protection function is enabled), the current song is saved and all song-related settings are stored.*

*The next time you turn the power on, all stored settings will be restored.*

## Canceling an assignment

When the Assign screen is displayed, pressing the **F1** (**DEFAULT**) button restores the initial settings. Likewise, pressing the **F2** (**ALL CLEAR**) button clears all assignment settings.

# 6 - Basic Recording

## Using phantom power

When connecting a condenser microphone that requires phantom power, press the **PHANTOM (+48V)** for **INPUT A** to **D** or **INPUT E** to **H** when the recorder is stopped to turn the phantom power on or off.

When you turn the phantom power on, **PHANTOM (+48V)** button becomes lit and phantom power is supplied to the XLR jacks of **INPUT A** to **D** and/or **INPUT E** to **H**.

When the **GIUITAR** indicator is lit, however, **INPUT H** will not receive phantom power even if phantom (+48V) power is **ON** (indicator lit) for **E-H**.

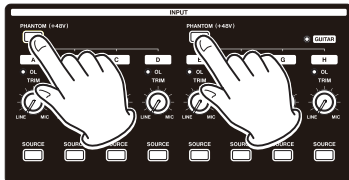

### CAUTION

- Use the **STEREO** fader and **MONITOR LEVEL** knob to lower the output volume of the unit before turning phantom power on or off. Depending on the microphone, a loud noise could occur, damaging equipment and harming people's hearing.
- Do not connect or disconnect a microphone when phantom power is turned on. Doing so could cause a loud noise and might damage this unit and connected equipment.
- Turn phantom power on only when using a condenser microphone that requires phantom power. Turning phantom power on when a dynamic mic or other mic that does not require it is connected could damage this unit and connected equipment.
- When using condenser mics that require phantom power and dynamic mics together, be sure to use balanced dynamic mics. Unbalanced dynamic mics cannot be used when phantom power is enabled.
- Supplying phantom power to some ribbon mics will break them. If you are unsure, do not supply phantom power to a ribbon mic.

## Monitoring

Monitoring is an important element of the recording and mastering process. You can use an external monitoring system (self-powered monitor speakers, amplifier equipped with speakers, etc.) or headphones to monitor the sound of this unit.

Use the **MONITOR LEVEL** knob to adjust the level of the monitoring system.

## Monitor selection

Besides the stereo bus, this unit allows you to monitor the bounce bus (see "Bouncing tracks" on page 43) or Effect Sends 1/2.

In the Effect Sends monitoring, you can monitor the signals being sent to the effects.

1. When the Home screen is displayed, press the **MONITOR SELECT** button to open the **MONITOR SELECT** pop-up window.



2. Use the **JOG/DATA** dial or the **CURSOR** (▲/▼) buttons to select the monitor destination.

### STEREO (default)

Select this to monitor the stereo signal of the stereo bus.

### BOUNCE

Select this to monitor the stereo signal of the bounce bus.

### EFFECT SEND 1

Select this to monitor the mono signal of the Effect Send 1.

### EFFECT SEND 2

Select this to monitor the mono signal of the Effect Send 2.

3. After selecting the monitor destination, press the **MONITOR SELECT** button to return to the Home screen.

## OL indicators and level meters

You can check the audio signal levels of this unit through the **OL** indicators for **INPUT A** to **H** and the level meters shown on the display.

The level meters allow the signal levels to be monitored, and they can also be used to confirm whether signals are being input into the unit. For example, if the level meters assigned to inputs **A** to **H** on the Home screen are moving, this means that signals are being input into the unit even if you cannot hear anything when monitoring.

As shown below, if a red line "■" appears at the top of a level meter, the level is too high (it stays on screen for a while before automatically disappearing). If the level is too loud, the sound might be distorted, so lower the level until the red line "■" stops appearing.

If an **OL** indicator lights, the signal from the input source might be too loud or the **TRIM** knob set too high.

If the **OL** indicator lights even though the **TRIM** knob is set to the **LINE** position, the input source signal is too loud, so lower the volume on the input source.

Overload indication

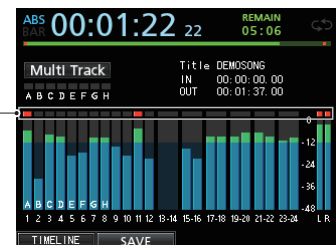

### ■ Overload indicators (A to H)

The overload indicators for inputs **A** to **H** on the display show the overload of the input level (**INPUT A** to **H**) of this unit.

Use the **TRIM** knobs of **INPUT A** to **H** or the output volume controls of the input sources to adjust the level.

## Track level meters (1 to 23/24)

These level meters show either the playback signal levels or the input signal levels of the corresponding tracks. The signal levels shown by the track level meters depend on the operating conditions as shown below.

REC button	Transport status	Level meter display contents
Unlit	Playback	Track playback signal
Flashing (recording standby)	Playback	Track playback signal (Auto Monitor ON) Track input signal + playback signal (Auto Monitor OFF)
Flashing (recording standby)	Stopped	Track input signal
Lit (recording)	Recording	Track input signal

### NOTE

*During playback signal display, since the level of the signal being recorded on the track is shown, the level cannot be changed.*

*During input signal display, you can change the levels with the TRIM knobs of INPUT A to H.*

## Stereo level meter (L, R)

This meter shows the output level of this unit's stereo bus. Adjust the output level with the **STEREO** fader.

## Peak hold display

Using the peak hold function, you can set how long peak levels are shown on the level meters on the Home Screen and other screens.

- When the recorder is stopped, press the **MENU** button to open the **MENU** screen.
- Use the **JOG/DATA** dial or the **CURSOR** (▲/▼/◀/▶) buttons to select **PREFERENCE**, and then press the **F4** (▶) button.

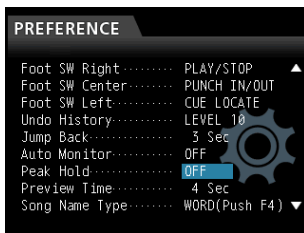

- Use the **CURSOR** (▲/▼) buttons to select the Peak Hold item, and then use the **JOG/DATA** dial to change the setting.

Option	Function
OFF (default value)	Peak value is not shown.
1Sec	Peak value is shown for about one second.
KEEP	In mastering mode, the peak value is cleared when you locate a new time. In all other modes, press the <b>F3</b> (PEAK CLEAR) button to clear the peak value.

- After making the settings, press the **HOME** button to return to the Home screen.

### TIP

*When you are unable to monitor the meters continuously (when playing, for example), use the **KEEP** setting to check the highest level so far.*

## Setting the Mixer screen

Press the **SOURCE** button for an input or press the **SELECT** button for a track to adjust its EQ and other settings.

## Using the input equalizer

**INPUT A** to **INPUT H** and track 1 to track 23/24 have independent 3-band EQs (equalizers).

### CAUTION

*The effect of the input equalizer will be recorded. If you plan to make EQ adjustments during mixdown, turn input equalizers OFF and turn track equalizers ON.*

Adjust the equalizer settings on the Mixer screen.

- Press the **MIXER** button to open the Mixer screen.

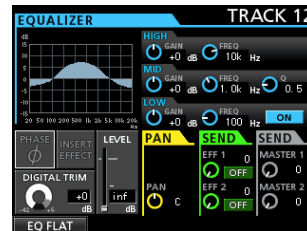

- Press the **SOURCE** button of INPUT A to H or the **SELECT** button of each track to open the Mixer screen to set the corresponding equalizer.
- Press the **EQUALIZER ON/OFF** button on the right side of the **LOW** knob to turn the equalizer on/off.

The equalizer parameters are as follows.

	GAIN	FREQ
<b>HIGH</b>	High gain Setting range: ±12dB (Default: 0dB)	High frequency Setting range: 1.7kHz to 18kHz (Default: 10kHz)
<b>MID</b>	Mid gain Setting range: ±12dB (Default: 0dB)	Mid frequency Setting range: 32Hz to 18kHz (Default: 1.0kHz)
<b>LOW</b>	Low gain Setting range: ±12dB (Default: 0dB)	Low frequency Setting range: 32Hz to 1.6kHz (Default: 100Hz)

Use the **SELECT** button of each track to select the desired track.

Press the **SOURCE** button of each **INPUT** to change the input.

Use the **HIGH**, **MID**, and **LOW GAIN** knobs to adjust the gain.

Use the **HIGH**, **MID**, and **LOW FREQ** knobs to adjust the frequency.

Use the **MID Q** knob to set the **MID FREQ** bandwidth.

**Setting range:** 0.25 to 16 (Default: 0.5)

Press the **EQUALIZER ON/OFF** button to turn the equalizer on or off.

# 6 - Basic Recording

## NOTE

- "Q" refers to the center frequency of the equalizer divided by the bandwidth. A high Q value reduces the cut and/or boost applied to the frequencies. Depending on the equalizer setting, the graph at the top of the screen changes.
  - If you press the **F1 (EQ FLAT)** button, all the settings on the open Mixer screen will be restored to their default values.
4. After making the settings, press the **HOME** button to return to the Home screen.

## DIGITAL TRIM setting (Track only)

Depending on the playback sound, EQ boosting could cause distortion (digital clipping). If this happens, use the DIGITAL TRIM to lower the playback level before the EQ.

1. Use the **CURSOR** (▲/▼/◀/▶) buttons to move the cursor to the **DIGITAL TRIM** display area.

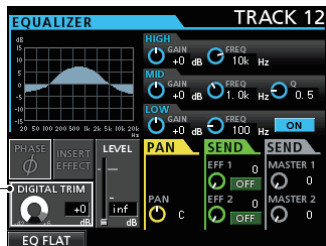

DIGITAL TRIM indication

2. Turn the **JOG/DATA** dial to set the value.  
**Setting range:** -42 dB to +6 dB (Default: 0 dB)

## Sending signals to internal/external effects

This unit has two external effect send systems (**EFF 1** and **EFF 2**) and a send for the internal effects (**INSERT EFFECT**).

You can adjust send levels for each track. For details about the built-in send effects, see "Send effects" on page 54.

1. Use the **CURSOR** (▲/▼/◀/▶) buttons to move the cursor to the **SEND EFF 1/EFF 2** area.

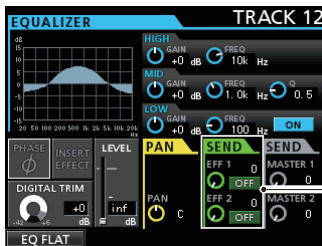

Effect send indication

2. Turn the **JOG/DATA** dial to enable the effect.  
**Options:** OFF (default), PRE, POST

### PRE

This sends the track pre-fader signal to the effect send bus. The effect send signal level is not affected by the track fader.

### POST

This sends the track post-fader signal to the effect send bus. The effect send signal level is affected by the track fader.

3. Use the **SEND EFF 1/EFF 2** knobs to adjust the external send levels.

**Setting range:** 0 to 127 (Default: 0)

4. Use the **SEND MASTER 1/MASTER 2** to adjust the send master level.

**Setting range:** 0 to 127 (Default: 0)

## Enabling insert effects

This unit has dynamic and guitar effects that can be used as insert effects.

1. Use the **CURSOR** (▲/▼/◀/▶) buttons to move the cursor to the **INSERT EFFECT** display area.

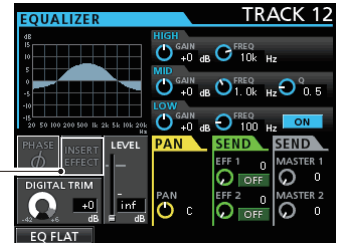

INSERT EFFECT indicator

2. Turn the **JOG/DATA** dial to set the insert effect.

### Options:

- OFF: INSERT EFFECT indicator unlit (default)
- ON: INSERT EFFECT indicator lit

## Setting the stereo position

Use the **PAN** parameter to set the stereo position.

The full left value is L63, and the full right value is R63. The center position is shown by C.

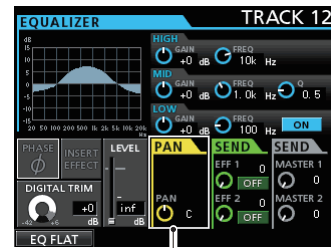

PAN indication

Turn the **PAN** knob to adjust the stereo position.

**Setting range:** L63 to C to R63 (Default: C)

## Changing the signal phase

When the phase is inverted due to the mic wiring or other reason, use the **PHASE 0** display area to correct the phase.

1. Use the **CURSOR** (▲/▼/◀/▶) buttons to move the cursor to the **PHASE 0** display area.



Phase

2. Turn the **JOG/DATA** dial to change the built-in signal phase.

### Options:

- PHASE 0 indicator unlit (default): Normal phase
- PHASE 0 indicator lit: Inverted phase

## Checking the fader level

Check the level on the **LEVEL** display area on the Mixer screen for each track. Operations cannot be made on this display. Operations for **LEVEL** on the Mixer screen for each input (INPUT A to H) are explained below.

1. Use the **CURSOR** (▲/▼/◀/▶) buttons to move the cursor to the **LEVEL** display area.

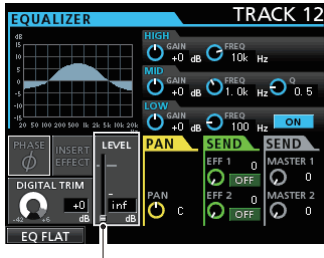

Fader level indication

2. Turn the **JOG/DATA** dial to adjust the level.

**Setting range:** inf to +6.0dB

When playing back a track, in the initial settings, the positions of the faders (physical faders) on the top panel and the actual level of the faders (internal faders) are always matched, but a fader group could make them to differ. Even in this case, when you move a physical fader, the internal fader matches the physical fader value, and thereafter the physical fader controls the level.

### CAUTION

*A sudden level change may occur.*

## Solo

Press the **SOLO** button to select the Solo mode. The **SOLO** button becomes lit.

In Solo mode, the **REC** button of each track works as a **SOLO** button, so you can monitor the signal of the desired track.

The Solo mode of this unit is a solo-in-place monitor, so all other tracks are muted except the one whose **REC** button was pressed.

1. When the Home screen is displayed, press the **SOLO** button to select the Solo mode.

In Solo mode, the **SOLO** button becomes lit.

2. Press the **REC** button for the track you want to turn soloing on/off.

When Solo mode is activated, the **MUTE/SOLO** indicator of the track whose **REC** button was pressed lights.

### ■ To cancel soloing

In Solo mode, press the **SOLO** button or the **REC** button to which track solo is enabled.

When Solo mode is deactivated, the **MUTE/SOLO** indicator of the track whose **REC** button was pressed goes off.

## Muting tracks

1. Press the **MUTE** button to enter Mute mode.  
In Mute mode, the **MUTE** button becomes lit.
2. Press the **REC** button for the track you want to turn muting on/off.

When muting is turned on, the **MUTE/SOLO** indicator of the track whose **REC** button was pressed lights.

### ■ To cancel muting

Press the **MUTE** button to enter the Mute mode.

Press the **REC** button of a muted track to cancel muting (its **MUTE/SOLO** indicator goes off).

### NOTE

*If you solo a muted track, you can hear its sound, but its muted status is retained. So, it will be muted again when you end soloing.*

## Rehearsing the recording

This unit has a recording rehearsal function, so you can rehearse without actually recording.

The rehearsal function is specially useful for the auto punch recording and other recording operations. (See "Automatic punching in and out" on page 46.)

In a rehearsal, monitoring and other recording operations are the same as for the actual recording, but the input signal is not recorded.

To rehearse, press the **REHEARSE** button so that the button becomes lit.

When you record in Rehearsal mode, the **RECORD** (●) button flashes instead of becoming lit.

After finishing your rehearsal, press the **REHEARSE** button to cancel the Rehearsal mode.

## Making the first recording

Before beginning the following recording procedures, connect a recording source (a microphone or guitar) to an input, assign that input as the recording source for a track, and prepare your monitoring equipment.

1. Press the **REC** button of the track that you want to record on.

The **REC** button flashes red and the unit enters recording standby.

A maximum of eight tracks can be recorded simultaneously.

When the **REC** buttons of eight tracks are flashing, the other **REC** buttons become inoperative.

2. Set the recording level.

Use the **TRIM** knobs of **INPUT A** to **H** to adjust the input level.

When doing this, adjust the level appropriately by checking the **OL** indicator on the upper left corner of the **TRIM** knob.

At the same time, confirm that the sound heard from the headphones or monitoring system is not distorted, and that an unintentional sound effect is not set up.

### NOTE

*The level meter of the track that has an input source assigned to it shows the input level after the application of INPUT equalizer.*

*The OL indicator lights if the input is too loud.*

*If the OL indicator stays lit even when you lower the TRIM knob for that input, lower the input source signal level.*

3. Press the **REHEARSE** button to select the Rehearsal mode.  
In Rehearsal mode, **Rehearsal** appears on the upper left corner of the Home screen.
4. Press the **RECORD** (●) button.

## 6 - Basic Recording

The recording rehearsal starts, the **RECORD (●)** button flashes, and the **PLAY (▶)** button becomes lit.

The **REC** button of the track that will be recorded stays flashing.

- After rehearsing your recording, press the **STOP (■)** button.
- Press the **REHEARSE** button to exit the Rehearsal mode. **Rehearsal** disappears from the upper left corner of the Home screen.
- Press the **RECORD (●)** button.  
The recording starts, the **RECORD (●)** button and the **PLAY (▶)** button become lit.  
The **REC** button of the recorded track stops flashing and becomes lit.
- After finishing your recording, press the **STOP (■)** button.
- If you want to check a part of the recording, use the **REW (◀◀)** (**TO ZERO**) button, for example, to move to it (locate).

### TIP

Use the **TO LAST REC** function to move to the last recording position and the **TO ZERO** function to return to the start of the song (00:00:00). For more information about the **rewind/fast-forward and locate** functions, see "Returning to zero or the last recording position" on page 44.

- 1 Press the **PLAY (▶)** button to play back the recorded track. Use the track faders and **STEREO** fader to adjust the playback level.  
Use the **MONITOR LEVEL** knob or the volume control on your monitoring system to set the final monitoring volume.  
Use the **PAN** knobs on the corresponding Mixer screen to set the stereo position of each track between the left and right speakers.

### NOTE

- The track **PAN** knobs on the Mixer screen of each track and the track faders control the recorded track's playback output signal or the monitoring sound of the input signal. They do not control the signal being recorded to the track.
- If you are not satisfied with the recorded sound, repeat the procedure above from the beginning.

## Multitrack recording

You can record new sounds to different tracks while playing back already recorded tracks.

### Setting the tracks for recording

- Press the **REC** buttons of the already recorded tracks to turn off the **REC** buttons.
- Press the **REC** buttons of the tracks that you want to record to put them into recording standby (the **REC** buttons start flashing).

### Setting track pan and level

Use the track faders and **PAN** knobs on the Mixer screen of the already recorded tracks to adjust the levels and stereo positions for monitoring the playback signals while making new recording.

## Input selection and assignment

Use the procedures described earlier in this chapter to assign input sources to the recording tracks.

## Setting input levels

After making the settings, press the **PLAY (▶)** button to start playback.

Just as though you were recording, you can monitor the sound of already recorded tracks playing back and the input sources on the tracks for recording, allowing you to check the monitoring balance and volume.

## Recording

Press the **RECORD (●)** button.

Now you can start recording to another track while monitoring the playback signal.

## Undoing an operation

This unit allows you to undo an operation or recording that was not successful or satisfactory. Many ordinary operations, including editing and recording, can be canceled (undone).

This unit has two types of undo functions. Single undo can be performed by a simple button press, while multi-undo allows you to return to a specific past operation and undo the operations that occurred after it.

You can use the undo function for the following operations.

- Track editing operations (functions described in this chapter)
- Recording operations (including track bouncing)
- Automatic punching in/out

All these operations are stored on the SD card as song information. Even when you turn the unit off (standby), the previous operations are stored and can be undone when you turn on the unit again.

When listening to a part that you replaced in your last recording, for example, you find that the previous take was better. In such a case, you can use the undo function to easily get your previous take back.

### NOTE

The **UNDO/REDO** button becomes lit when a single undo or multi-undo has been performed.

## Undo feature settings

- When the recorder is stopped, press the **MENU** button to open the **MENU** screen.
- Use the **JOG/DATA** dial or the **CURSOR (▲/▼/◀/▶)** buttons to select (green highlight) **PREFERENCE**, and then press the **F4 (▶)** button.



The **PREFERENCE** menu screen appears.

- Use the **CURSOR (▲/▼)** buttons to select (blue highlight) **Undo History**.



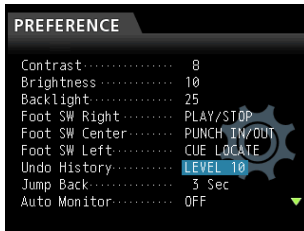

4. Set canceling (undo) operations.

### LEVEL 1 (Default)

HISTORY LIST is not displayed when you press the **UNDO/REDO** button. In other words, this returns the unit to the state before the last operation (single operation). (To cancel the undo, perform REDO.)

### LEVEL 10

When you press the **UNDO/REDO** button, HISTORY LIST appears and you can return to the state before up to 10 past operations.

### NOTE

*Even when you change from LEVEL 10 to LEVEL 1, the history for a maximum of 10 actions remains stored. The position of the cursor on the list shows the current position.*

## Undoing the last operation (single undo)

Press the **UNDO/REDO** button to return to the state before the last operation.

After doing this, the **UNDO/REDO** button lights, showing that redo (see below) is possible.

### ■ Canceling an undo operation (redo)

Press the **UNDO/REDO** button when it is lit.

The last action is enabled again, the unit returns to its newest state, and the **UNDO/REDO** button becomes unlit.

## Undoing older operations (multiple undo)

To perform the multi-undo, first you must set Undo History on the PREFERENCE menu to LEVEL 10. (See "Undo feature settings" on page 40.)

1. Set Undo History on the PREFERENCE menu to LEVEL 10.

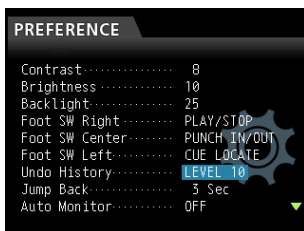

2. When the Home screen is displayed, press the **UNDO/REDO** button to display HISTORY LIST.

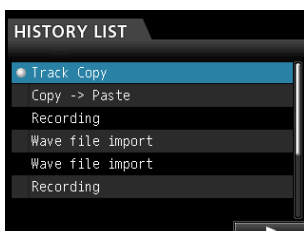

The maximum number for the undo history is 10. In other words, a maximum of 10 operations can be undone.

This operation is called "multi-undo" because it allows you to undo multiple events and return to an earlier state.

3. Use the **JOG/DATA** dial to select (blue highlight) the event that you want to return to (all events after the selected event will be undone).
4. Press the **F4** (▶) button.

The multi-undo is performed and the song is restored to the state just after the selected event was performed.



In this state, the **UNDO/REDO** button lights.

The event information undone through the above operation is not erased. The unit has simply been returned to a previous state.

On the HISTORY LIST screen, ● icon appears next to the last event after undoing. When the most recent event is selected on HISTORY LIST, pressing the **F4** (▶) button returns to the most recent operation.

### CAUTION

- When saving a song, a maximum of 10 operation history events can be saved with the song data. If the number of operation history events exceeds 10, the oldest events in the history are erased. These erased events cannot be restored.
- Since the history information is stored as the song information, even when the power is turned off (standby), the previous operation remains stored, so the undo operation is also possible next time the power is turned on.
- If you perform an operation that is added to the history when the **UNDO/REDO** button is lit after a multi-undo operation has been performed, the history after the multi-undo will be erased.

# 7 - Recorder Functions

## Punching in and out

Punching in/out is a technique to replace a part of an already recorded track.

Start playback and when you reach the part that you want to replace, switch to record (punch in), then switch back to playback (or stop) when you finish the part that you want to replace (punch out).

1. Decide what part of the track you plan to replace.  
Choose a point to begin where the new recording can sit well with the existing recording.
2. Press the **REC** buttons of the tracks that you want to replace to put them into recording standby (**REC** buttons start flashing).
3. Start playback before the part you want to replace.
4. When the part you want to replace is reached, press the **RECORD (●)** button and start your performance.  
The unit switches to recording (punch in).
5. When you finish the replacement recording, press the **PLAY (▶)** button.  
The unit switches to playback (punch out).

### TIP

You can also press the **STOP (■)** button to punch out at the end of the replacement recording.

## Using a foot switch to punch in/out

You can connect the dedicated foot switch (TASCAM RC-3F) to the **REMOTE** jack on the front panel and use it to punch in and out.

In step 4 above, step on the foot switch instead of pressing the **RECORD (●)** button, and in step 5, step on the foot switch again instead of pressing the **PLAY (▶)** button.

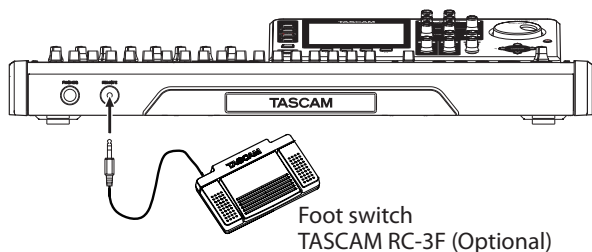

### NOTE

Step on the switch (pedal) that you have set to **PUNCH IN/OUT** in the foot switch settings. In the initial settings, the pedal C (center) is set to **PUNCH IN/OUT**. (See "Setting the foot switch" below.)

## Setting the foot switch

Set the foot switch on the **PREFERENCE** screen.

1. When the recorder is stopped, press the **MENU** button to open the **MENU** screen.
2. Use the **JOG/DATA** dial or the **CURSOR (▲/▼/◀/▶)** buttons to select (green highlight) **PREFERENCE**, and then press the **F4 (▶)** button.

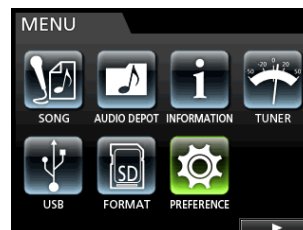

The **PREFERENCE** screen appears.

3. Use the **CURSOR (▲/▼)** buttons to select (blue highlight) **Foot SW Right**.

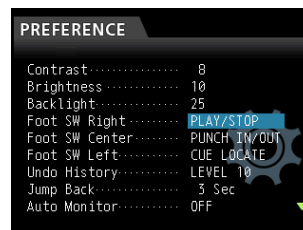

4. Use the **JOG/DATA** dial to select the function that you want to assign to the pedal R (right) of the TASCAM RC-3F foot switch.  
**Options:** **PLAY, REC, STOP, FF, REW, PUNCH IN/OUT, PLAY/STOP (Default: Pedal R), CUE LOCATE**
5. In the same way, set the functions for the pedal C (center) in **Foot SW Center**, and for the pedal L (left) in **Foot SW Left**.  
**Options:** **PLAY, REC, STOP, FF, REW, PUNCH IN/OUT (Default: Pedal C), PLAY/STOP, CUE LOCATE (Default: Pedal L)**
6. After making the settings, press the **HOME** button to return to the Home screen.

### ■ Foot switch function list

Function	Description
PLAY	Same as the unit's <b>PLAY (▶)</b> button
REC	Same as the unit's <b>RECORD (●)</b> button
STOP	Same as the unit's <b>STOP (■)</b> button
FF	Same as the unit's <b>F FWD (▶▶) (TO LAST REC)</b> button
REW	Same as the unit's <b>REW (◀◀) (TO ZERO)</b> button
PUNCH IN/OUT	Punches in when pressed during playback, punches out when pressed during recording.
PLAY/STOP	Starts playback when stopped, stops in other states.
CUE LOCATE	Locates the last point where playback started.

## Bouncing tracks

Like many multitrack recorders, this unit allows you to bounce tracks (ping-pong recording technique). Track bouncing allows you to collect signals of multiple tracks and use them to perform new mono or stereo recording. In this way, you can virtually record more than 24 tracks. Note, however, that the original tracks cannot be separated again.

In Bounce mode, the recording source track signals pass through the mixer tracks via the bounce bus, and they are sent to the bounce tracks.

If you make a mistake, you can use the undo function of this unit to undo the incorrect operation (see “Undoing an operation” on page 40).

## Performing the track bouncing

1. When Recorder mode is **Multi Track** mode and the recorder is stopped, press the **BOUNCE** button. The Recorder mode switches to **Bounce** mode.

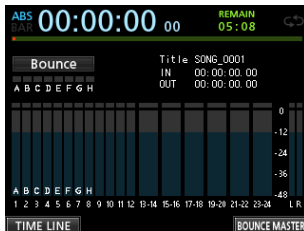

### NOTE

*In Bounce mode, Bounce appears on the upper left corner of the Home screen.*

2. Press the **REC** button of the track that you want to make the bounce destination, which will cause the **REC** button to flash.
 

When making a stereo bouncing, press two **REC** buttons for the tracks from 1 to 12, or press one **REC** button for a stereo track from 13/14 to 23/24, which will cause the button(s) to flash.

For a mono bouncing (single track bouncing), press one of the **REC** buttons for tracks from 1 to 12 so that its button starts flashing.

You should also set the fader of the bounce destination track to 0 dB.

### NOTE

*Though the track fader and STEREO fader settings of the bounce destination affect the monitor volume, they do not affect the recording level. If you want the monitoring level to be the same as the recording level, set the fader for the bounce destination track to 0 dB.*

3. Press the **SELECT** button to specify the bounce source.
 

Except for the bounce destination, you can select from all tracks and inputs as bounce sources. To set an input as a bounce source, assign it to a stereo bus and press its **SOURCE** button.

Use the track fader and the **PAN** knobs on the Mixer screen to adjust the track specified as the bounce destination.

For stereo bouncing, the lower numbered track becomes the left channel.

In the case of mono bounce, set the **PAN** knob on the Mixer screen of the track that will be the bounce source completely to the **L** side.

To adjust the bounce master level when in Bounce mode, press the **F4** (**BOUNCE MASTER**) button to show a fader. Use the **JOG/DATA** dial to adjust it.

### CAUTION

*If the bounce source is selected before selecting the destination, the audio signals of the bounce source are not output from the STEREO OUTPUT jack or monitor's STEREO until you select the bounce destination.*

4. Locate to the point where you want to start the bounce and press the **RECORD** (●) button to execute the track bounce. The track bouncing starts.
 

Press the **STOP** (■) button at the position where you want to end the bounce.

## Checking the result

Mute the bounce original tracks and play back the song. (See “Muting tracks” on page 39.)

If you are not satisfied with the result because you think the balance between the instruments or the pan setting is not good, for example, undo the operation. (See “Undoing an operation” on page 40.)

If you are satisfied with the result, press the **BOUNCE** button to return to the **Multi Track** mode of the Recorder mode.

Once the track bounce is completed, you can make new recordings over (overwrite) the other tracks, except for the bounced track.

### TIP

*If it is possible that you might need the original tracks at some time later, before bouncing tracks, copy or back up the song data to a computer. (See “Copying songs” on page 32 and “Connecting to a computer” on page 67.)*

### CAUTION

*To monitor the original sound recorded on the bounce track, set the monitor destination to BOUNCE so that you can monitor the bounce bus.*

## Direct Location Function

You can specify a time or measure/beat to be located without using marks. On the Home screen, use the **JOG/DATA** dial to specify the location point.

The Home screen counter has two display types: **ABS** (absolute time) and **BAR** (bar/beat).

The **BAR** display is based on the metronome setting.

In **BAR** mode, you can locate a position in beat units.

The current position of the recorder is shown as a time (measure-beat) at the top of the Home screen. The tempo is also displayed.

The **ABS** display is based on the absolute time. In **ABS** mode, you can locate a position in frame units. The current position of the recorder is shown as a time (hours : minutes : seconds) on the top of the Home screen (30 frames per second).

You can specify a time in this time display area and move the current position of the recorder.

# 7 - Recorder Functions

## Locating directly a specified time

In **ABS** mode, you can locate a specified time directly through the following two methods. This direct location cannot be performed by this method during recording.

1. Press the **HOME** button to open the Home screen.
2. **ABS** is displayed on the left side of the counter of the Home screen.

If it is not displayed, press the **METRONOME** button to open the **METRONOME** screen.

Use the **CURSOR** (**▲** / **▼**) buttons to select **BAR DISP** item of the **METRONOME** screen, and then use the **JOG/DATA** dial to set it to **OFF**, which will cause **ABS** to appear.

3. Turn the **JOG/DATA** dial to change the time (the time advance speed changes according to the speed of turning the dial).
4. After setting the desired time value, press the **PLAY** (**▶**) button which will cause the playback to start.

## Locating directly a specified measure/beat

Like the time specification location in **ABS** mode, you can locate a position by specifying a music point in **BAR** mode.

You can perform the direct location of a preset point through the procedure below.

This direct location cannot be performed by this procedure during recording.

1. Press the **HOME** button to open the Home screen.
2. **BAR** is displayed on the left side of the counter of the Home screen.

If it is not displayed, press the **METRONOME** button to open the **METRONOME** screen.

Use the **CURSOR** (**▲** / **▼**) buttons to select the **BAR DISP** item of the **METRONOME** screen, and then use the **JOG/DATA** dial to set it to **ON**, which will cause **BAR** to appear.

3. The value wraps automatically when it reaches the highest or lowest value in a field.

When set to 4/4 and the beat field exceeds 04, for example, the bar value will increase by one, and the beat field will return to 01.

In the same way, when you turn the **JOG/DATA** dial to lower a value and passes through 01, the bar value will decrease and the total value will change in succession. When set to 4/4, for example, if the value drops below 01 when the cursor is located under the beat field, the bar value will decrease by one, and the beat field will return to 04.

4. After setting the desired measure/beat, press the **PLAY** (**▶**) button which will cause the playback to start.

## Location marks

This unit allows you to set up to 99 location marks in each song. For example, you can mark the intro, vocal entry points, start of verses, etc.

## Setting a location mark

When stopped, during recording or playback, press the **MARK SET** button at the point where you want the location mark.

A mark number (**MARK xx**) appears on the Home screen (**xx** is the mark No.).

The displayed mark No. indicates the current position mark or the mark immediately before. A flag icon is also displayed above the timeline.

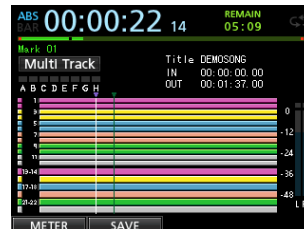

### NOTE

*The marks are numbered in the order you enter them. The marks do not appear according to their position in the song. Therefore, **MARK 05** can appear before **MARK 01** in a song.*

## Skipping to location marks

Press the **F FWD** (**▶▶**) (**TO LAST REC**) button or the **REW** (**◀◀**) (**TO ZERO**) button to skip to the next or previous mark.

## Deleting a location mark

You can delete marks when the recorder is stopped.

1. Press the **F FWD** (**▶▶**) (**TO LAST REC**) button or the **REW** (**◀◀**) (**TO ZERO**) button to move to the mark that you want to delete.
2. Press the **MARK SET** button to delete the location mark.

### NOTE

- *Marks are displayed in time order. They do not appear in the order of their numbers.*
- *This operation cannot be undone. Make sure you want to execute it.*

## Returning to zero or the last recording position

You can easily move to the beginning of the song (00:00:00:00 = ZERO point) or to the last recording position (LAST REC point) through a simple button operation.

To return to the beginning of the song (00:00:00:00 = ZERO point), press and hold the **STOP** (**■**) button and press the **REW** (**◀◀**) (**TO ZERO**) button (TO ZERO function).

To return to the last recording position (LAST REC point), press and hold the **STOP** (**■**) button and press the **F FWD** (**▶▶**) (**TO LAST REC**) button (TO LAST REC function).

This function is useful when you want to record again after finishing recording.

## Fast forwarding and rewinding

During playback or stop, press the **REW (◀◀) (TO ZERO)** button or the **F FWD (▶▶) (TO LAST REC)** button to rewind or fast-forward while the button is pressed. The rewind and fast-forward speed is fixed at 10 times.

## Cueing with the JOG/DATA dial

You can use the **JOG/DATA** dial to position a playback position precisely. There are two methods of positioning: viewing the track's waveform and listening to the track sounds.

### Jogging while viewing a waveform

1. Use the transport button or location function to move the playback position near a position where you want to cue.
2. Press the **JOG PLAY** button to enter the search mode.  
You can switch between the timeline display and waveform display by pressing the **F1** key. Select the waveform display screen.



3. Press the **SELECT** button of a track whose waveform you want to view.  
The waveform of the selected track appears.  
If a stereo track is selected, the displayed track (odd or even) changes each time the **SELECT** button is pressed, and only the displayed track can be monitored.
4. Use the **CURSOR (◀/▶)** buttons to scale up/down the display horizontally (time) as necessary.  
Press the **CURSOR (◀)** button to scale down horizontally (time), or the **CURSOR (▶)** button to scale up.  
Also, use the **CURSOR (▲/▼)** buttons to scale up/down the display vertically (audio level).  
Press the **CURSOR (▲)** button to scale up vertically (audio level), or the **CURSOR (▼)** button to scale down.  
Scaling up makes it easier to cue the position precisely.
5. Use the **JOG/DATA** dial to find a cue point.
6. When the cue point is determined, press the **JOG PLAY** button to return to the Home screen.

### Jogging while listening to audio

1. Use the transport button or location function to move the playback position near a position where you want to cue.
2. Press the **JOG PLAY** button to enter the search mode.  
You can switch between the timeline display and waveform display by pressing the **F1** key. Select the timeline display screen.
3. Use the **CURSOR (◀/▶)** buttons to scale up/down the display horizontally (time) as necessary.  
Press the **CURSOR (◀)** button to scale down horizontally (time), or the **CURSOR (▶)** button to scale up.  
Scaling up makes it easier to cue the position precisely.

Now, jog sounds can be heard. (Jog sound refers to a repeat playback sound of a short period.)

4. Use the **JOG/DATA** dial to find a cue point while changing the jog sound playback position.
5. When the cue point is determined, press the **JOG PLAY** button to return to the Home screen.

#### NOTE

*The transport button is available even in search mode. However, while the timeline is displayed, pressing the PLAY button switches between the normal playback and jog sound playback, and pressing the STOP button performs jog sound playback. When in jog mode, you can move in 1/10 frame (1/300 seconds) units. You can also set IN and OUT points with 1/10 frame precision.*

## Repeat playback

Use the repeat playback function to play the same part again and again.

The repeat playback interval is the section between the IN and OUT points.

### Setting IN/OUT points

In addition to setting the repeat playback interval, the IN and OUT points are also used to set track editing intervals and as the punch in and punch out points when automatically punching in and out. Moreover, these points are used as the start and end points of the mixdown master file when creating a master file.

You can set these points during recording, playback or when the unit is stopped.

#### NOTE

*The IN and OUT points cannot be set or edited in the following cases.*

- In Repeat Playback mode
- In Auto Punch mode
- In Mastering mode of the Recorder mode

#### ■ Adding IN/OUT points

Regardless of whether the unit is stopped, playing back or recording, when the recorder is at the desired position, press and hold the **MARK SET** button and press the **IN** or **OUT** button. The position where you pressed the **IN/OUT** button is set and the time is displayed on the Home screen.

#### ■ Locating IN/OUT points

When stopped or during playback, press the **IN** or **OUT** button.

# 7 - Recorder Functions

## Using repeat playback

1. Set the IN point and the OUT point you want to make the start and end points of the repeat playback interval, and then return to the Home screen.
2. Press the **REPEAT** button.  
The  icon appears on the Home screen, and repeat playback starts.

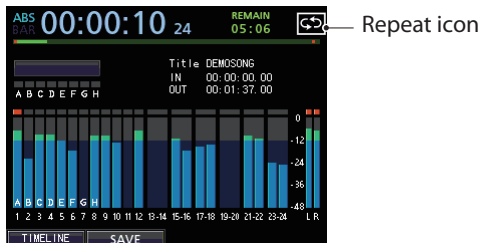

After the playback starts from the IN point and reaches the OUT point, it returns to the IN point and repeats. Playback continues to repeat between the IN and OUT points.

3. To cancel the repeat playback, press the **REPEAT** button, so that the  icon disappears from the Home screen.

## Jumpback playback

Press the **JUMPBACK (PREVIEW)** button during playback to move back a few seconds (adjustable) and restart playback (Jump back function).

If you want to hear a passage again during playback, press the **JUMPBACK (PREVIEW)** button to go back a few seconds and replay that passage.

1. When the recorder is stopped, press the **MENU** button to open the **MENU** screen.
2. Use the **JOG/DATA** dial or the **CURSOR (▲/▼/◀/▶)** buttons to select (green highlight) **PREFERENCE**, and then press the **F4 (▶)** button.



The **PREFERENCE** screen appears.

3. Use the **CURSOR (▲/▼)** buttons to select (blue highlight) **Jump Back**, then use the **JOG/DATA** dial to set the value for the jump back playback.

**Options: 1 Sec to 10 Sec, 20 Sec, 30 Sec (Default: 3 Sec)**

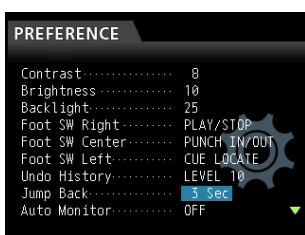

4. After making the settings, press the **HOME** button to return to the Home screen.

5. Press the **JUMPBACK** button during playback to move back by the time set in step 3.

## Checking cueing points (preview)

You can perform a playback to check whether the cueing is appropriately performed.

1. When the recorder is stopped, press the **MENU** button to open the **MENU** screen.
2. Use the **JOG/DATA** dial or the **CURSOR (▲/▼/◀/▶)** buttons to select (green highlight) **PREFERENCE**, and then press the **F4 (▶)** button.



The **PREFERENCE** screen appears.

3. Use the **CURSOR (▲/▼)** buttons to select (blue highlight) **Preview Time**, then use the **JOG/DATA** dial to set the value for the preview playback.

**Preview Time: 1 Sec to 10 Sec (1 sec increments) (Default: 4 Sec)**

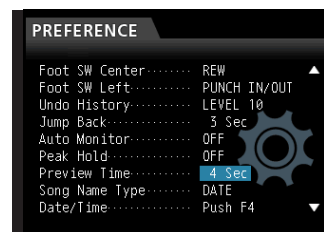

4. After making the settings, press the **HOME** button to return to the Home screen.
5. Perform preview playback using either of the following methods:

While playback is stopped, holding the **PREVIEW** button and pressing the **OUT** button plays from the current time by the preview time, returns, and then stops.

While playback is stopped, holding the **PREVIEW** button and pressing the **IN** button plays from the time returned by the preview time to the current time, and then stops.

## Automatic punching in and out

You can use the punch in/out function to perform an automatic record from the punch in to the punch out points you previously set.

When performing the auto punch in/out recording, the playback starts from the pre-roll point before the start recording point (punch in point) and when punch in point is reached, the record starts. After that, when the recording end point (punch out point) is reached, the unit switches to the playback of the post-roll part and stops.

In the auto punch in/out recording, the recording track monitor changes as follows.

- Pre-roll period: Track playback signal + input source signal
- Punch in–out interval: Input source signal
- Post-roll period: Track playback signal + input source signal

In the auto punch in/out function of this unit, the above monitoring changes occur not only during the actual recording, but also in the Rehearsal mode.

In Rehearsal mode, you can simulate the auto punch in/out recording. Therefore, you can rehearse your performance and also check whether the IN point and OUT point are appropriately set.

You can also use the punch in/out in combination with the repeat function. By using these functions in combination, you can repeatedly rehearse the punch in/out recording, or record the same section several times (multi-take), leaving the unit working automatically to you. When performing multitrack recording, you can choose the best from recorded takes.

## Setting punch-in/out points

There are two ways to set the punch-in/out points.

### LAST REC:

This option sets the start and end points of the last recording (or recording rehearsal) as the punch in/out points.

The display returns to the Home screen, and **Auto Punch** appears on the top of the screen.

### IN - OUT:

This option sets the IN point and the OUT point as the punch in/out points. The first of these points will be used as the punch in point, and the second as the punch out point.

The display returns to the Home screen, and **Auto Punch** appears on the top of the screen.

1. When the recorder is stopped, press the **HOME** button to open the Home screen.
2. Press the **REC** button for the track that you want to punch in/out automatically.
3. Press the **AUTO PUNCH** button to open the **AUTO PUNCH** screen.

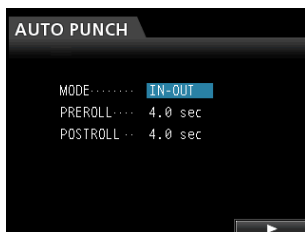

4. Use the **CURSOR** (▲/▼) buttons to select (blue highlight) **MODE**, **PREROLL** or **POSTROLL**, and then use the **JOG/DATA** dial to select the value.

MODE: LAST REC or IN-OUT  
 PREROLL: 1.0 to 9.9 sec  
 POSTROLL: 1.0 to 9.9 sec

After setting **MODE**, **PREROLL**, and **POSTROLL**, press the **F4** (▶) button.

You can press the **AUTO PUNCH** button to return to the Home screen without entering Auto Punch In/Out mode.

### NOTE

*You can press the **AUTO PUNCH** button before putting any tracks into recording standby. Press the **REC** button of any track to put it into recording standby after enabling automatic punching.*

## Checking punch-in/out points

When punch-in/out points are set, you can confirm the setting by pressing the **PLAY** (▶) button.

The playback starts from the pre-roll point and continues to the post-roll point. When the punch-in point is reached, on tracks armed for recording, already recorded audio will be muted and only input signals will be heard. When the punch-out point is reached, already recorded audio and input signals will both be heard.

If you want to change the punch-in/out points, locate the desired points and set them again.

If there are no problems with the punch-in/out points and pre-roll and post-roll times rehearse recording, as described below.

## Rehearsing with automatic punching

You can rehearse before performing punch in/out. In the rehearsal, the monitor operates the same way as for the actual recording, but the recording is not performed.

1. When the **AUTO PUNCH** button is lit and one of the tracks is in recording standby, press the **REHEARSE** button.  
The **REHEARSE** button becomes lit.
2. Press the **RECORD** (●) button.  
Auto punch in/out rehearsal starts.
  - Playback starts from the pre-roll point. You can monitor both the track playback signal and the input source signal.
  - When the punch in point is reached, the monitoring changes to input source signal only, and the **RECORD** (●) button starts flashing (to indicate this is a rehearsal).
  - When the punch out point is reached, the monitoring of both the track playback signal and input source signal starts, and the **RECORD** (●) button becomes unlit.
  - Playback continues until the post-roll point and stops.

Before starting your rehearsal, you can press the **REPEAT** button (so that all three **AUTO PUNCH**, **REHEARSE**, and **REPEAT** buttons become lit), to repeat the rehearsal operation until you press the **STOP** (■) button.

# 7 - Recorder Functions

## Recording with automatic punching

After rehearsing, record with auto punch in/out.

1. Press the **REHEARSE** button to turn off the **REHEARSE** button.
2. Press the **RECORD (●)** button.
  - Playback starts from the pre-roll point. You can monitor both the track playback signal and the input source signal.
  - When the punch in point is reached, the monitoring changes to input source signal only, and the **RECORD (●)** button lights.
  - When the punch out point is reached, the monitoring of both the track playback signal and input source signal starts, and the **RECORD (●)** button becomes unlit.
  - Playback continues until the post-roll point and stops.

Before starting the punch in/out recording, you can press the **REPEAT** button so that the **REPEAT** button becomes lit, and then, using the virtual track feature, repeat the punch in/out recording until 8 times (8 takes).

After the recording, you can choose your favorite take from one of the 8 takes recorded in the virtual tracks. (See "Checking a take" below.)

### NOTE

*You can undo auto punch in/out operations.*

## Checking a take

After recording a take, follow the procedure below to check the take.

Once the punch in/out recording is completed, the **VIRTUAL TRACK** screen appears as follows.

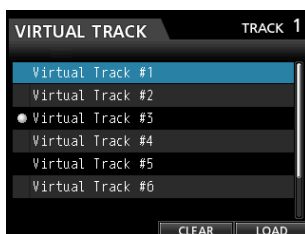

1. Use the **JOG/DATA** dial or the **CURSOR (▲/▼)** buttons to select (blue highlight) a take from the list.
2. Press the **F4 (LOAD)** to load, assign each virtual track to a physical track, and check the playback. Repeat steps **1** and **2** to check another take.
3. If you are satisfied with the result, press the **VIRTUAL TRACK** button to exit Virtual Track mode.

To exit from Auto Punch mode too, press the **AUTO PUNCH** button.

If you are not satisfied with the result, press the **RECORD (●)** button again and record another take.

## Virtual tracks

This unit allows 8 virtual tracks for each track.

Since there are 8 virtual tracks for each track, you can record multiple takes of lead vocals or improvised solos, and then choose the best takes afterwards.

After recording, assign a separate virtual track to a physical track, and then record another take. By repeating this process, you can use multiple virtual tracks to hold different takes.

## Recording to virtual tracks

Follow these procedures to record a virtual track.

1. Select the track.
2. Press the **VIRTUAL TRACK** button.
3. Select **UNUSED**.
4. Press the **F4 (LOAD)** button to assign the virtual track to be recorded to.
5. Once you have completed the setting, press the **HOME** button to return to the Home Screen.

## Assigning virtual tracks

Follow these procedures to assign a virtual track to a physical track.

1. Press the **SELECT** button of a track you want to assign a virtual track to when the Home screen is displayed, and then press the **VIRTUAL TRACK** button.

The **VIRTUAL TRACK** screen appears.

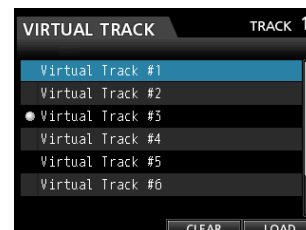

You can also press the **VIRTUAL TRACK** button first, then select a track on the **VIRTUAL TRACK** screen.

### NOTE

*When creating a song, the virtual track #1 is assigned to each physical track.*

*Recording, playback, and editing is only possible with virtual tracks assigned to physical tracks.*

*You can also assign an already recorded virtual track to a physical track and record over it.*

2. Use the **JOG/DATA** dial to select the virtual track that you want to assign.
3. Press the **F4 (LOAD)** button to assign the virtual track to a physical track.

The assignment to the physical track is shown by an icon on the screen.

### NOTE

- To delete a virtual track, press the **F3 (CLEAR)** button in step **3** above.
- A virtual track assigned to a physical track cannot be deleted.
- You can assign an unused virtual track. The track becomes an empty track.



# 8 - Track Editing

Editing on a conventional tape recorder in the past required advanced techniques, but with this unit editing tracks is easy and accurate.

Moreover, with a tape recorder, an editing error could not be undone, but this unit uses non-destructive editing, allowing you to edit without altering the original data. This means that the undo function can be used to correct an edit easily. (See "Undoing an operation" on page 40.)

## Overview of track editing

This unit has the following track editing functions.

- COPY/PASTE
- COPY/INSERT
- MOVE/PASTE
- MOVE/INSERT
- OPEN (Insert Silence)
- CUT (Remove Part)
- SILENCE (Erase Part)
- CLONE TRACK (Track Duplication)
- CLEAN OUT (Delete Track)

## Editing points

Among the track editing functions, COPY/PASTE, COPY/INSERT, MOVE/PASTE, and MOVE/INSERT use the IN/OUT/TO points as editing points.

OPEN, CUT, and SILENCE use IN/OUT points as editing points.

These IN/OUT points are the same IN and OUT points used during repeat playback.

### ■ IN point

The IN point is the start point for the part of the track subject to track editing.

Press and hold the **MARK SET** button and press the **IN** button to set the IN point at the current position.

### ■ OUT point

The OUT point is the end point for the part of the track subject to track editing.

Press and hold the **MARK SET** button and press the **OUT** button to set the OUT point at the current position.

### ■ TO point

- The TO point is the current position (current point).

### NOTE

*If you press the **JOG PLAY** button to enable jog mode, you can set IN and OUT points with subframe (1/10 frame) precision.*

## Basic editing procedures

1. When the recorder is stopped, press the **TRACK EDIT** button to open the **TRACK EDIT** screen.

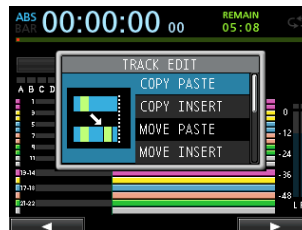

2. Use the **JOG/DATA** dial or the **CURSOR** (**▲**/**▼**) buttons to select (blue highlight) the desired track editing function, and then press the **F4** (**▶**) button.

The corresponding function screen appears.



COPY PASTE screen

3. Select the setting item value.  
If there are multiple setting items, use the **CURSOR** (**▲**/**▼**) buttons to select one, and then use the **JOG/DATA** dial to set the value.
4. Press the **F2** (**YES**) button to execute the function.

### NOTE

*Press the **F1** (**NO**) button to return to the **TRACK EDIT** screen without executing the function.*

## Explanation of items

### ■ SOURCE Track

This is the source editing track.

The choices available depend on the editing function.

- 1 to 12: Single track
- 13/14 to 23/24: Stereo track  
You can also use the **SELECT** buttons of the tracks.
- ALL: 1 to 24 tracks

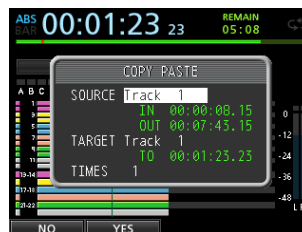

COPY PASTE screen

# 8 - Track Editing

## ■ IN/OUT/TO

To set the IN/OUT/TO points again, exit the **TRACK EDIT** screen, and set them again from the beginning.

## ■ TARGET Track

This is the target editing track. In the case of OPEN, CUT, SILENCE, and CLEAN OUT, it becomes the target track itself.

The choices depend on what you have already chosen for the **SOURCE Track**.

When a single track is specified as the **SOURCE Track**, the **TARGET Track** options are 1 to 12 (single tracks).

When a stereo track (e.g. 13/14) is specified as the **SOURCE Track**, the **TARGET Track** options are 13/14 to 23/24 (stereo track).

- You can also use the **SELECT** buttons of the tracks.

When **ALL** (all tracks) is specified as the **SOURCE Track**, the **TARGET Track** option is **ALL** (all tracks) only.

## ■ TIMES

Set the number of times that the copied section will be pasted. Set the number between 1 and 99.

---

## COPY/PASTE

---

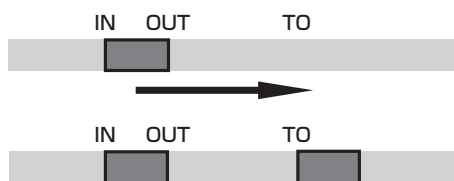

This function copies the audio data from between the IN and OUT points on the COPY source track, and pastes it on the COPY destination track starting from the TO point. This operation does not change the COPY source track.

This operation overwrites recorded data on the COPY destination track. Therefore, the length of the COPY destination track is not changed.

You can make multiple copies in a single operation.

In other words, you can overwrite the COPY destination track from the TO point with a designated number of repetitions of the COPY data.

The following parameters are used in this operation.

- **SOURCE Track** (1 to 12, 13/14 to 23/24, ALL)
- **IN/OUT/TO**
- **TARGET Track**
- **TIMES**

---

## COPY/INSERT

---

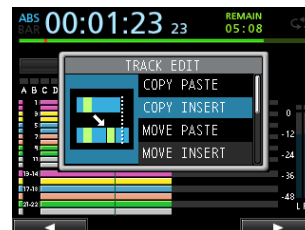
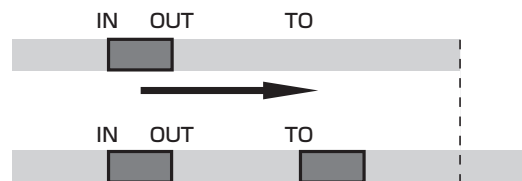

This function copies the audio data from between the IN and OUT points on the COPY source track, and inserts it on the COPY destination track starting from the TO point. This operation does not change the COPY source track.

This operation inserts recorded data into the COPY destination track. The recorded data on the COPY destination track after the TO point is offset by the amount of time used by the inserted audio data. Therefore, the COPY destination track becomes longer.

You can make multiple copies in a single operation. In other words, you can insert a designated number of repetitions of the COPY data into the COPY destination track from the TO point.

The following parameters are used in this operation.

- **SOURCE Track** (1 to 12, 13/14 to 23/24, ALL)
- **IN/OUT/TO**
- **TARGET Track**
- **TIMES**

## MOVE/PASTE

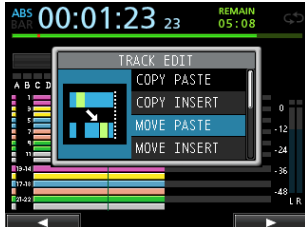
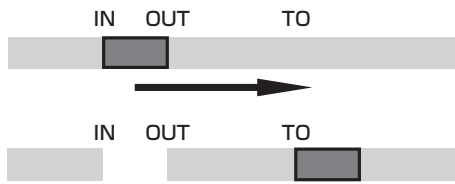

The audio data between the IN and OUT points on the MOVE source track is removed and pasted on the MOVE destination track starting from the TO point. This operation leaves a silence between the IN and OUT points on the MOVE source track.

This operation overwrites recorded data on the MOVE destination track. Therefore, the length of the MOVE destination track is not changed.

The following parameters are used in this operation.

- **SOURCE Track** (1 to 12, 13/14 to 23/24, ALL)
- **IN/OUT/TO**
- **TARGET Track**

## MOVE/INSERT

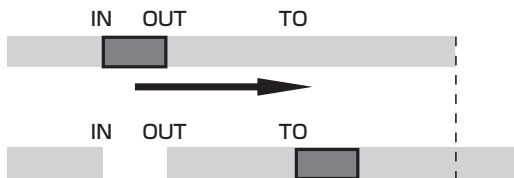

The audio data between the IN and OUT points on the MOVE source track is removed and inserted in the MOVE destination track starting from the TO point. This operation leaves a silence between the IN and OUT points on the MOVE source track.

This operation inserts recorded data into the MOVE destination track starting from the TO point. Therefore, the MOVE destination track becomes longer.

The following parameters are used in this operation.

- **SOURCE Track** (1 to 12, 13/14 to 23/24, ALL)
- **IN/OUT/TO**
- **TARGET Track**

## OPEN (Insert Silence)

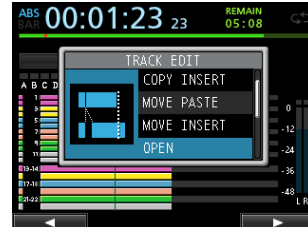
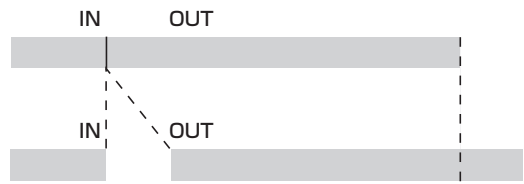

This function inserts silence between the IN and OUT points on the selected track.

This function splits the track at the IN point and shifts the recorded data after the IN point to after the OUT point. Therefore, the track becomes longer.

The following parameters are used in this operation.

- **TARGET Track** (1 to 12, 13/14 to 23/24, ALL)
- **IN/OUT**

## CUT (Remove Part)

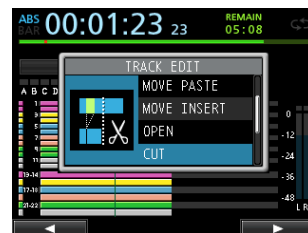
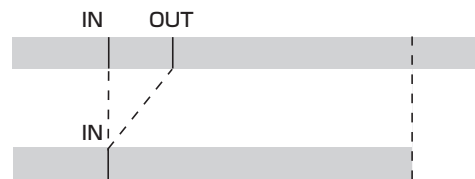

This function cuts (deletes) the audio data between the IN and OUT points on the selected track, and shifts the remaining recording after the OUT point forward to the IN point. Therefore, the track becomes shorter.

The following parameters are used in this operation.

- **TARGET Track** (1 to 12, 13/14 to 23/24, ALL)
- **IN/OUT**

# 8 - Track Editing

## SILENCE (Erase Part)

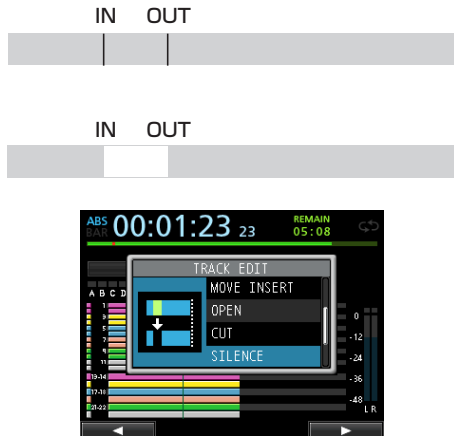

This function cuts (deletes) the audio data between the IN and OUT points on the selected track.

This is the same as leaving silence between the IN and OUT points, as though there had been no recording.

This operation does not change the length of the track.

The following parameters are used in this operation.

- **TARGET Track** (1 to 12, 13/14 to 23/24, ALL)
- **IN/OUT**

### TIP

*You can use this function to delete short noises, for example.*

## CLEAN OUT (Delete Track)

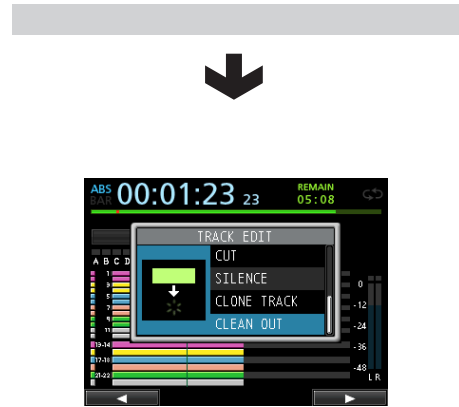

Use this function to completely erase the selected track.

This deletes the entire track, so IN/OUT/TO points have no effect.

The following parameters are used in this operation.

- **TARGET Track** (1 to 12, 13/14 to 23/24, ALL)

## CLONE TRACK (Track Duplication)

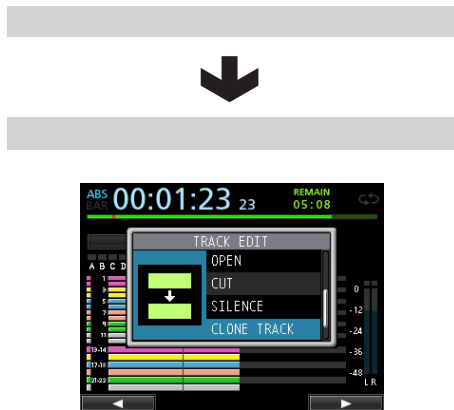

Use this function to duplicate a single track or a stereo track to a different track.

This copies the entire track, so the IN/OUT/TO points have no effect.

The following parameters are used in this operation.

- **SOURCE Track** (1 to 12, 13/14 to 23/24)
- **TARGET Track**

### NOTE

*If you choose the same track for both SOURCE Track and TARGET Track, Same Track appears and the operation cannot be executed.*

# 9 - Using Built-In Effects

This chapter explains the dynamic effects, guitar effects, and send effects that can be applied to individual mic and guitar inputs.

You can select one of the four types of dynamic effects (COMPRESSOR, NOISE SUPPRESSOR, DE-ESSER, EXCITER) to apply to all inputs (**INPUT A to H**).

The library data can also be used for other songs.

Even when the parameters are not stored in the library data, the effect assignments and parameters are always stored as part of a song.

## Dynamic effects

When you press the **DYNAMICS** button, the effect inserted in the last selected input (**INPUT A to H**) is displayed.

You can select one of the four types of effects (COMPRESSOR, NOISE SUPPRESSOR, DE-ESSER, EXCITER) and apply it to all inputs (**INPUT A to H**) (though the simultaneous application has some limitations).

You cannot use multiple types of effects simultaneously.

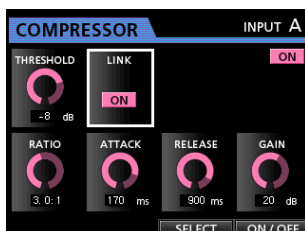

### CAUTION

*When using a guitar effect together with a dynamic effect, the dynamic effect can be only inserted into a maximum of 2 channels.*

*The selected input is displayed on the screen. (INPUT A to H)  
The on/off state is also displayed on the screen.*

## Inserting a dynamic effect

Press the **DYNAMICS** button to open the **DYNAMICS** screen. Press the **SOURCE** button to select the input (**INPUT A to H**) into which you want to insert the dynamic effect.

Press the **F3 (SELECT)** button to select the effect that you want to insert. Press the **F4 (ON/OFF)** button to set the selected effect to **ON** and insert it.

You can also align the cursor with **INSERT EFFECT** on the Mixer screen and use the **JOG/DATA** dial to turn the effect on/off.

## Editing a dynamic effect

You can edit the parameters of the selected dynamic effect. The editing parameters differ depending on the effect type.

Use the **CURSOR (▲/▼/◀/▶)** buttons to select the parameter that you want to change, and then use the **JOG/DATA** dial to select the value.

### NOTE

*There is no preset or storage functions available.*

## Guitar effects

This unit has multi-effects for guitar. You can insert these effects into the tracks for use.



## Inserting a guitar effect

Press the **EFFECT** button to open the **GUITAR EFFECT/SEND EFFECT** screen (the last displayed effect appears).

When the **SEND EFFECT** screen is displayed, press the **F1 (GUITAR)** button to open the **GUITAR EFFECT** screen. If there is any effect already inserted in a track, the **SELECT** button is lit and the track number appears on the upper right corner of the screen.

If there is no effect inserted, the **SELECT** button is unlit, and **TRACK --** appears on the upper right corner of the screen.

Press the **SELECT** button of the track which you want to insert the effect into, and the effect will be inserted.

You can also align the cursor with **INSERT EFFECT** on the Mixer screen and use the **JOG/DATA** dial to turn the effect on/off.

### CAUTION

*Guitar effects can be also inserted into stereo tracks. When inserting into a stereo track, though the stereo effect can be achieved depending on the effect used, since the input is monaural and the output is monaural/stereo, observe the following precautions.*

- *Since the effect input is monaural, when it is inserted into a stereo track, the odd numbered track input becomes active. Therefore, if you want to achieve the stereo effect when recording a stereo track inserted with an effect, set the input assignment to monaural.*

*Example: assigning H/H to 13/14 tracks*

## Editing guitar effects

You can edit the parameters of the selected guitar effect. The editing parameters differ depending on the effect type.

Press the **F3 (SELECT)** button to select the effect that you want to edit.

Use the **CURSOR (▲/▼/◀/▶)** buttons to select the parameter that you want to change, and then use the **JOG/DATA** dial to select the value.

Select whether you apply the effect during recording or during playback with the **POSITION** parameter on the Guitar Effect screen.

## 9 - Using Built-In Effects

### Calling effects from the guitar effect library

1. On the Guitar Effect screen, press the **F2** (LIBRARY) button to display the library list.
2. Use the **JOG/DATA** dial to select the effect setting that you want to call, and then press the **F4** (►) button.
3. The setting is called and the display returns to the Guitar Effect screen.

Press the **F1** (◀) button to return to the Guitar Effect screen without changing the parameter.

#### NOTE

*The preset data is stored in PRESET, and the user settings are stored in USER.*

### Saving guitar effects in the library

You can save an edited setting as a user setting in the library.

1. When the Guitar Effect screen is displayed, press the **F2** (LIBRARY) button to display the PRESET/USER library list. Use the **JOG/DATA** dial to select the USER area, and then press the **F3** (SAVE) button.

#### NOTE

*The library list contains a PRESET area and a USER area. PRESET area data cannot be overwritten.*

2. Enter a name, if necessary.  
Names of the PRESET library cannot be changed.

### Send effects

The send effects can be used to send signals to Send Effect 1.

You can select one among the 3 types of send effects (REVERB, DELAY, CHORUS) available. You cannot use multiple types of effects simultaneously.

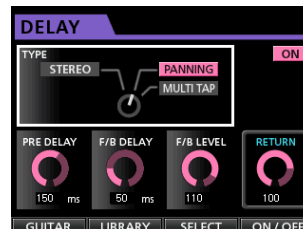

### Using send effects

You can send input channel or track signals to the send effects. Channel signal send levels and pre/post selection are performed on the Mixer screen. (See "Sending signals to internal/external effects" on page 38.)

The return from this effect is sent to the stereo bus. In Bounce mode, however, it is sent to the bounce bus. (See "Bouncing tracks" on page 43.)

### Editing send effects

The parameter editing is performed on the EFFECT screen.

Press the **EFFECT** button to open the EFFECT screen, and while the Guitar Effect is displayed, press the **F1** (SEND) button to switch to the Send Effect screen.

Press the **F3** (SELECT) button to select the effect type (REVERB, DELAY, CHORUS).

Use the **CURSOR** (▲/▼/◀/▶) buttons to select the parameter that you want to change, and then use the **JOG/DATA** dial to select the value.

### Calling the send effect library

1. On the Send Effect screen, press the **F2** (LIBRARY) button to display the library list.
2. Use the **JOG/DATA** dial to select the effect setting that you want to call, and then press the **F4** (►) button.
3. The setting is called and the display returns to the Send Effect screen.

Press the **F1** (◀) button to return to the Send Effect screen without changing the parameter.

### Saving send effects in the library

You can save an edited setting as a user setting in the library.

1. When the Send Effect screen is displayed, press the **F2** (LIBRARY) button to display the PRESET/USER library list. Use the **JOG/DATA** dial to select the USER area, and then press the **F3** (SAVE) button.

#### NOTE

*The library list contains a PRESET area and a USER area. PRESET area data cannot be overwritten.*

2. Enter a name if necessary.  
Names of the PRESET library cannot be changed.

# 10 - Mixing Down and Mastering Tracks

## Mixing down tracks

Mixing down tracks is the process of adjusting the volumes and stereo positions of each recorded track and mixing them into a well-balanced stereo track.

Including recorded tracks (24 maximum) and inputs (8 maximum), you can mix down up to 32 tracks in total.

## Levels and balance

Use the track faders to balance the relative levels of the tracks. Then, use the **STEREO** fader to adjust the overall level. Watching the stereo level meters on the display, adjust the level until it is suitable.

If the volume is too loud, the sound will be distorted.

### NOTE

*The track meters on the display show the recorded signal levels of the tracks. Therefore, these meters do not change when the **TRACK** faders are adjusted.*

### TIP

*You do not need to keep the entire song at the same volume. For example, you could gradually increase the volume during a guitar solo.*

## Fader group

You can control multiple faders simultaneously. Set or release a group while the **FADER GROUP** button is lit.

### ■ Grouping tracks

1. Press the **FADER GROUP** button.
2. Adjust the level and balance between tracks you want to control.
3. Press the **SELECT** buttons of tracks to control.

The lit **SELECT** button indicates a track with a group set.

The track fader with the smallest number will be the master fader, and faders with a group set can be controlled. While a fader other than the master fader is operated, the **SELECT** button of the master fader blinks.

This fader group retains the relative level difference from the master fader at the time of setting internally in dB. The physical fader interval is not retained.

### NOTE

*When a group has been set, it will not be cancelled even if you press the **FADER GROUP** button. (The **FADER GROUP** button blinks.)*

*In this case, if the master fader is operated, the **SELECT** buttons of tracks with a group set light during operation.*

*If another fader is operated, the **SELECT** button of the master fader blinks during operation.*

### ■ Ungrouping tracks

1. Press and turn off all the **SELECT** buttons of tracks with a group set.
2. Press the **FADER GROUP** button.

If you press the **FADER GROUP** button before turning off all the buttons (there is still a lit button), the **FADER GROUP** button blinks to indicate that the group setting is active.

### CAUTION

*After canceling the group setting, the positions of the physical faders and the actual fader levels (internal fader) may not match. In such a case, when you move a physical fader, the internal fader matches the physical fader value, and thereafter the physical fader controls the level. In this case, a sudden level change may occur.*

### NOTE

*After setting a group, if it is released or added to and the master fader is changed, the track level is reset to the physical fader value.*

## Stereo position (panning)

Use the **PAN** knobs on the Mixer screen of each track to set the stereo position of the track signal.

## Track equalizer

Each track has a 3-band equalizer.

The equalizer setting is made on the Mixer screen (TRACK 1 to TRACK 23/24).

For a stereo track, the adjustment is the balance (BAL).

1. Press the **MIXER** button to open the Mixer screen.



2. Adjust the track equalizer.

The equalizer parameters are as follows.

	GAIN	FREQ
<b>HIGH</b>	High gain Setting range: $\pm 12$ dB (Default: 0dB)	High frequency Setting range: 1.7kHz to 18kHz (Default: 10kHz)
<b>MID</b>	Mid gain Setting range: $\pm 12$ dB (Default: 0dB)	Mid frequency Setting range: 32Hz to 18kHz (Default: 1.0kHz)
<b>LOW</b>	Low gain Setting range: $\pm 12$ dB (Default: 0dB)	Low frequency Setting range: 32Hz to 1.6kHz (Default: 100Hz)

Use the **SELECT** button of each track to select the desired track.

Use the **HIGH**, **MID**, and **LOW GAIN** knobs to adjust the gain of each band.

Use the **HIGH**, **MID**, and **LOW FREQ** knobs to adjust the center frequency of each band.

Use the **MID Q** knob to set the resonance (width) of the **MID FREQ** band.

Setting range: 0.25 to 16 (Default: 0.5)

Press the **EQUALIZER ON/OFF** button to turn the equalizer on or off.

Use **INPUT SOURCE (A-H)** buttons to select inputs to set the equalizer. (See "Using the input equalizer" on page 37.)

# 10 - Mixing Down and Mastering Tracks

3. After making the settings, press the **HOME** button to return to the Home screen.

## Send effects

This unit has 3 types of send effects.

Adjust the level of the signal sent to the effect from each track by using their **SEND EFF 1/EFF 2** knobs.

### NOTE

*The return level from the send effect (RETURN LEVEL) can be adjusted on the Send Effect screen.*

1. Press the **EFFECT** button to open the Effect screen.



2. Set the send effect.

Press the **EFFECT** button to open the Effect screen where the last operation was performed. Press the **F3 (SELECT)** button to select one from the 3 available types (**REVERB**, **DELAY**, **CHORUS**). You cannot use multiple types of effects simultaneously.

Align the cursor with the parameter that you want to select, and then use the **JOG/DATA** dial to set the parameter.

The return from the send effect is mixed with the stereo signal.

3. After making the send effect setting, press the **HOME** button to return to the Home screen.
4. Use the **SEND EFF 1** knob to adjust the level of the signal sent to the send effect of each track.

### TIP

*When using an external effect, connect the output of the external effect (return) to **INPUT A to H**. By assigning the connected input to the stereo bus, you can return the effect sound to the stereo bus. (See "Assigning to a stereo bus" on page 35.)*

## Creating a master file

When you are satisfied with your mix, this unit can record the mixed down tracks and create a master file.

A master file recorded by this unit is saved as part of the song.

This master file can be recorded by an external stereo recorder, and can also be converted by the unit into a WAV file and stored with the same name of a song in the song folder of the SD card.

### NOTE

*Only one master file (song name ".wav") can be created inside a song (when mastering, there is another file besides the master file (song name ".wav"), but it is a file for internal use).*

## Setting the start and end points

Before creating a master file, set the start and end points of the mixed down master file. The range between the song's **IN** point and **OUT** point will be recorded as the master file.

Ordinarily, set the beginning of the song as the **IN** point and the end of the song as **OUT** point.

Press and hold the **MARK SET** button and press the **IN** button where you want to set the **IN** point (start point) of the master file, and press and hold the **MARK SET** button and press the **OUT** button where you want to set the **OUT** point (end point).

For more information about how to correct the **IN/OUT** points, see "Setting **IN/OUT** points" on page 45.



# 10 - Mixing Down and Mastering Tracks

## Creating a master file

After setting the IN and OUT points, you are ready to create the master file.

1. When Recorder mode is **Multi Track** mode, press the **MIXDOWN/MASTERING** button.

The Recorder mode switches to **Mixdown** mode and the display returns to the Home screen.

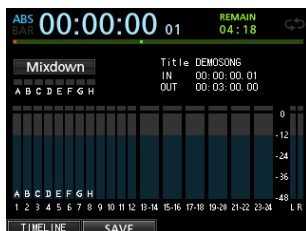

If you play or record, you can hear the signal of the mixed tracks (the signal to be recorded) through headphones or monitoring system.

### NOTE

- In **Mixdown** mode, **Mixdown** appears on the upper left corner of the Home screen.
  - If the interval between the **IN** and **OUT** points is shorter than 4 seconds, when you start the record, **Trk Too Short** appears and the mixdown recording cannot be performed.
  - When Recorder mode is **Mixdown** mode, some playback functions do not work. If you try to use one of these functions, **In Mixdown Mode** appears.
2. Press the **RECORD (●)** button.

The mixdown starts and the **RECORD (●)** button becomes lit.

Regardless of the recorder's current position, the mixdown starts from the **IN** point.

If necessary, use the track faders or the Mixer screen's **PAN** knobs to mix down the tracks to stereo. These adjustments will be reflected in the master file.

When the recorder reaches the **OUT** point, recording automatically stops.

3. If you want to redo the creation of the stereo master track, press the **RECORD (●)** button.

A new master file will be created, and the previous master file will be overwritten.

### NOTE

After recording the master file, you can play back the master file to check it. (See "Checking the master file" on the right column.)

## Exiting Mixdown mode

Press the **MIXDOWN/MASTERING** button twice to return to **Multi Track** mode of the Recorder mode.

## Checking the master file

Follow the procedure below to listen to a master file after you have completed recording it.

1. When Recorder mode is **Mixdown** mode, press the **MIXDOWN/MASTERING** button.

The Recorder mode switches to **Mastering** mode and the display returns to the **Mastering** screen.



### NOTE

- In **Mastering** mode, **Mastering** appears on the upper left corner of the Home screen.
  - When Recorder mode is **Multi Track**, press the **MIXDOWN/MASTERING** button to switch to **Mixdown** mode, and then press the **MIXDOWN/MASTERING** button again to switch to **Mastering** mode.
  - You cannot switch to **Mastering** mode if there is no master file.
2. In this state, press the **PLAY (▶)** button to play back the master file that you have created.

### CAUTION

Confirm that both the **EQ** and **COMP** items are set to **OFF**. If either is set to **ON**, the sound will be affected by the equalizer and/or compressor. (See "Using the mastering equalizer" on page 59 and "Using mastering compression" on page 59.)

3. When Recorder mode is **Mastering** mode, the transport buttons work as follows.
  - Press the **PLAY (▶)** button to play back the master file from the current position until its end.
  - Use the **REW (◀◀) (TO ZERO)** button and the **F FWD (▶▶) (TO LAST REC)** button to perform rewind/fast-forward in the same way as in ordinary Recorder mode.
  - Press the **STOP (■)** button to stop playback.
  - Track recording is not possible.
  - Repeat playback and location mark functions cannot be used.

Since the master file playback signal is output from the **STEREO OUT** jack, you can record the output to an external stereo recorder.

If you are not satisfied with the created master file, you can perform a new mixdown.

### NOTE

To listen to a master file recorded in a saved song, load the song, change the Recorder mode to **Mastering** mode, and then press the **PLAY (▶)** button to start playback.

## Ending master file checking

After checking the master file, press the **MIXDOWN/MASTERING** button to return to the **Multi Track** mode of the Recorder mode.

# 10 - Mixing Down and Mastering Tracks

## Finishing up a master file (mastering)

This unit has specialized tools for enhancing the sound of the master file. Use the equalizer, compressor, and normalize function to adjust the overall volume and sound quality.

Switch to **Mastering** mode and use the mastering tools to enhance the master file.

### Mastering procedures

Follow the steps below to perform mastering.

#### ■ Step 1 - Enter Mastering mode.

When Recorder mode is **Mixdown** mode, press the **MIXDOWN/MASTERING** button.

The Recorder mode switches to **Mastering** mode and the **Mastering** screen opens.



#### NOTE

- When Recorder mode is **Multi Track mode**, press the **MIXDOWN/MASTERING** button to switch to **Mixdown mode**, and then press the **MIXDOWN/MASTERING** button again to switch to **Mastering mode**.
- You cannot switch to **Mastering mode** if there is no master file.

#### ■ Step 2 - Use the mastering tools to adjust the sound.

You can use the following functions as mastering tools: EQUALIZER function (**F1** (EQ) button), COMPRESSOR function (**F2** (COMP) button) and NORMALIZE function (**F4** (NORM) button).

You also can choose between a multi-band and single-band type compressor on the **COMP MULTI** screen by pressing the **F2** (SINGLE) or **F2** (MULTI) button.

For the multi-band compressor, the parameter setting display of the **COMP MULTI** screen is split into **LOW BAND**, **MID BAND** and **HIGH BAND** areas for individual low, mid and high frequency adjustments.

Make the necessary settings in each tool screen. (For further details, see the following "Using the mastering equalizer," "Using mastering compression" and "Using normalize".)

When Recorder mode is **Mastering** mode, since you can use the **PLAY** (▶), **STOP** (■), **REW** (◀◀) (TO ZERO), and **FWD** (▶▶) (TO LAST REC) transport buttons, adjust the settings as you monitor the playback signal.

#### ■ Step 3 - Record a new master file using the mastering tools.

After adjusting the settings of the mastering tools, press the **RECORD** (●) button to start recording.

The recording starts and the **PLAY** (▶) and **RECORD** (●) buttons become lit.

Recording always starts from 00:00:00:00 regardless of the current position.

Recording in **Mastering** mode overwrites the master file.

At the end of the master file, recording finishes automatically and the position returns to 00:00:00:00.

#### NOTE

If you stop recording in the middle, a master file will be created until the time when you stopped the unit.

#### ■ Step 4 - Check your recording.

Turn the equalizer and compressor off before playing back the master file to check the mastering results.

Single undo and redo can be used, so you can compare the sound before and after mastering.

#### ■ If you are not satisfied with the result

Undo the operation to return master file to mixdown state, and apply the mastering tools again from step 1.

#### NOTE

Multi-undo and redo cannot be used when the Recorder mode is **Mastering mode**.

# 10 - Mixing Down and Mastering Tracks

## Using the mastering equalizer

- When the **Mastering** screen is displayed, press the **F1 (EQ)** button to open the **EQUALIZER** screen.

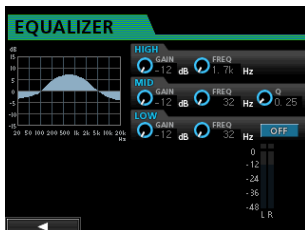

Mastering equalization is set on this screen.

- Adjust mastering equalization on this screen. The equalizer parameters are as follows.

	GAIN	FREQ
<b>HIGH</b>	High gain Setting range: $\pm 12$ dB (Default: 0dB)	High frequency Setting range: 1.7kHz to 18kHz (Default: 10kHz)
<b>MID</b>	Mid gain Setting range: $\pm 12$ dB (Default: 0dB)	Mid frequency Setting range: 32Hz to 18kHz (Default: 1.0kHz)
<b>LOW</b>	Low gain Setting range: $\pm 12$ dB (Default: 0dB)	Low frequency Setting range: 32Hz to 1.6kHz (Default: 100Hz)

Use the **HIGH**, **MID**, and **LOW GAIN** knobs to adjust the gain.

Use the **HIGH**, **MID**, and **LOW FREQ** knobs to adjust the center frequency.

Use the **MID Q** knob to set the **MID FREQ** bandwidth.

**Setting range:** 0.25 to 16 (Default: 0.5)

You use the **EQUALIZER ON/OFF** button to turn the equalizer on/off.

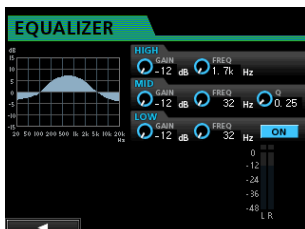

### NOTE

**Q** refers to the center frequency of the equalizer divided by the bandwidth. A high **Q** value reduces the cut and/or boost applied to the frequencies. Depending on the equalizer settings, the graph at the top of the screen changes.

- After making the settings, press the **F1 (◀)** button to return to the **Mastering** screen.
- The **EQ** item state of the **Mastering** screen is shown as **ON** or **OFF**.



## Using mastering compression

You can choose between a single band and a multi-band type of compressor.

Multi-band compressors allow independent settings for the low, mid and high frequency ranges, so you can adjust the overall volume balance. By using compression, you can also reduce unwanted peaks and increase the overall gain in order to raise the volume, creating a mastered sound with greater impact.

- When the **Mastering** screen is displayed, press the **F2 (COMP)** button to open the **COMP MULTI** screen.



- Press the **F3 (LIBRARY)** button to open the library list pop-up screen.

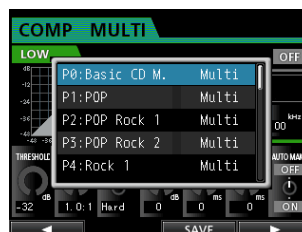

- Use the **JOG/DATA** dial or the **CURSOR (▲/▼)** buttons to select (blue highlight) the desired library, and then press the **F4 (▶)** button.

After the library is read, the display returns to the **COMP MULTI** screen.

- When using the multi-band compressor, move the cursor to the band display area, use the **JOG/DATA** dial to switch among the bands, and then set the parameter for each band as desired.



Multiband type



Single band type

At this time, the selected band is shown in the upper left corner.

- Use the **CURSOR (▲/▼/◀/▶)** buttons to select the item whose value you to change, and then use the **JOG/DATA** dial to change it.

# 10 - Mixing Down and Mastering Tracks

## THRESHOLD

Set the threshold value that determines when the compressor begins to operate.

## RATIO

Set the compression ratio.

## KNEE

Select the transition curve.

## GAIN

Adjust the output level.

## ATTACK

Adjust the attack time.

## RELEASE

Adjust the release time.

## AUTO MAKE

This feature automatically adjusts the release time to prevent it from being reduced by the compressor.

- When using the multi-band type, move the cursor to **CROSSOVER** and then use the **JOG/DATA** dial to adjust the frequency range of each band.



- Press the **F4** (ON/OFF) button to turn the compressor on or off. The ON or OFF state is shown on the Mastering screen.
- After setting the parameters, press the **F1** (◀) button to return to the Mastering screen.

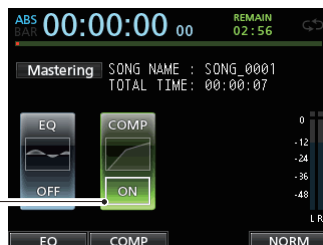

Compressor ON/OFF

## Using normalize

Use the normalize function to automatically adjust the volume. This function detects the highest volume level and raises the overall volume until the highest level reaches the maximum limit.

### CAUTION

*If you use equalization or compression after normalizing the track, distortion might occur.*

*Use the normalize function after adjusting the sound quality with equalization and compression.*

- When the Mastering screen is displayed, press the **F4** (NORM) button to open the NORMALIZE screen.

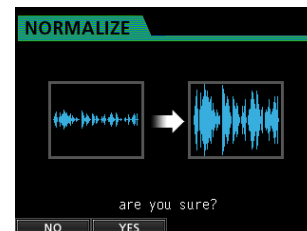

- Press the **F2** (YES) button to perform the normalization.
- Once the normalization is completed, the display returns to the Mastering screen.

## Exiting Mastering mode

To exit Mastering mode and return to Multi Track mode, press the **MIXDOWN/MASTERING** button.

# 11 - Various Other Functions

## Metronome

This unit has a built-in metronome.

The metronome works during the Recorder operation.

You can set it to work during both playback and recording or only during recording.

1. When the Recorder is stopped, press the **METRONOME** button to open the METRONOME screen.

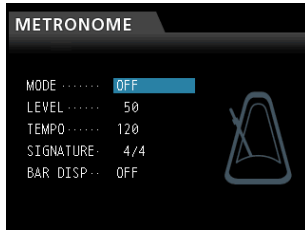

2. Set the following items.

Use the **CURSOR** (**▲**/**▼**) buttons to select the desired item, and then use the **JOG/DATA** dial to change its value.

### MODE

You can select from the following modes.

Mode	Description
OFF	Default, metronome OFF
REC&PLAY	Works both during recording and playback
REC	Works only during recording

### TEMPO

Set the speed.

The setting range is from 20 to 250 (BPM). (Default: 120)

### SIGNATURE

Set time signature to 4/4, 3/4, etc.

The setting range is from 1/1 to 12/8. (Default: 4/4)

### BAR DISP

Set the BAR display to ON/OFF. (Default: OFF)

### LEVEL

Set the metronome volume.

The setting range is from 0 to 127. (Default: 100)

3. After making the settings, press the **HOME** button to return to the Home screen.

The metronome works according to the **MODE** setting made in step 2 above.

When the setting is enabled, the **METRONOME** button flashes according to the metronome tempo.

The metronome signal is not recorded even if set to work during recording.

### NOTE

- When the metronome is working, you can monitor the sound of the metronome through connected external speakers. Note, however, that the metronome sound might also be recorded when you use a microphone to record.
- When the metronome is working, you can adjust the LEVEL item on the METRONOME setting screen, but other items cannot be changed.
- You can use the metronome as a click track to help keep time when recording rhythm guitar, bass, etc. at the beginning of a song.
- If you want to use the metronome for practice, you can either turn each track's fader all the way down during playback or play a song that does not have any recordings.

# 11 - Various Other Functions

## Tuner function

You can use the built-in chromatic tuner to tune guitars.

1. Connect the guitar or bass guitar to the MIC/LINE INPUTS H jack.  
Tuning cannot be performed on instruments connected to the **MIC/LINE INPUTS A to G** jacks.
2. Set the LINE-GUITAR switch on the rear panel to GUITAR .  
(See "Selecting the input sources" on page 35.)
3. When the recorder is stopped, press the **MENU** button to open the MENU screen.
4. Use the **JOG/DATA** dial to select the TUNER menu item and then press the **F4** (▶) button.

The TUNER screen appears.

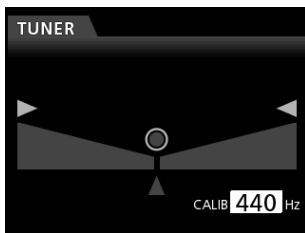

5. Use the **JOG/DATA** dial or the **CURSOR** (▲/▼) buttons to set the A4 (La) standard frequency.

The setting range is from 435Hz to 445Hz. (Default: 440Hz)

6. Play the instrument and begin tuning.

The pitch name closest to the string appears above the meters.

Tune the instrument so that the target pitch name appears and the center of the tuning meter lights.

A bar appears on the left or right of the center if the sound is lower or higher than the target pitch. The bar becomes longer as the sound shifts away from the target pitch.

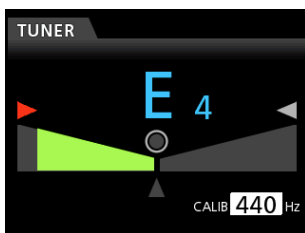

When the pitch played matches the note shown, the center "

○", "▶" and "◀" lights green.

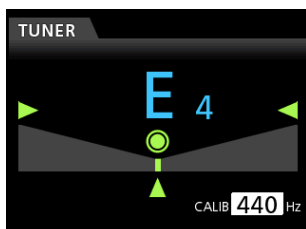

7. After tuning the instrument, press the **HOME** button to return to the Home screen.

### NOTE

The following buttons can be controlled in the Tuner mode.

**INPUT TRIM** (Analog)

**JOG/DATA** dial (Calibration)

Monitor level

## Setup (PREFERENCE)

You can use the PREFERENCE screen to change various settings to optimize the unit for your use environment and other requirements, as well as to restore the factory settings.

The PREFERENCE menu allows you to customize the unit to your preference.

Follow the procedure below to open the PREFERENCE screen.

1. When the recorder is stopped, press the **MENU** button to open the MENU screen.
2. Use the **JOG/DATA** dial or the **CURSOR** (▲/▼/◀/▶) buttons to select PREFERENCE, and then press the **F4** (▶) button.

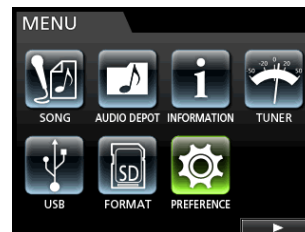

The PREFERENCE screen appears.

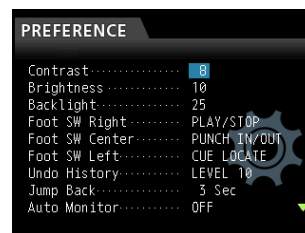

3. On the PREFERENCE screen, use the **CURSOR** (▲/▼) buttons to select a parameter, and then use the **JOG/DATA** dial to change its setting.
  - Auto Power Save (Set automatic power saving)
  - Contrast (LCD adjustment)
  - Brightness (LCD adjustment)
  - Backlight (LCD adjustment)
  - Foot SW Right (Foot switch R assignment)
  - Foot SW Center (Foot switch C assignment)
  - Foot SW Left (Foot switch L assignment)
  - Undo History (Switch over between level 1 and level 10)
  - Jump Back (Jump time setting)
  - Auto Monitor (Auto Monitor setting)
  - Preview Time (Preview time setting)
  - Peak Hold (Set peak hold time)
  - Song Name Type (Switching between DATE and WORD)
  - Date/Time (System time/date setting)
  - Initialize (Factory setting reset)

## Setting automatic power saving

Use the **Auto Power Save** item to set the amount of time until the unit power turns off after the last user operation or function completes.

The options and default value are as follows.

Options: OFF, 3Min, 5Min, 10Min, 30Min (default value)

### CAUTION

*By default, this is set to turn the unit off automatically after 30 minutes. Set this to "OFF" if you do not want the unit to turn off automatically.*

### NOTE

*The Auto Power Save Function is disabled under the following conditions.*

- During recording or playback
- When the metronome is in use
- When the record function is ON
- When a signal is output from the **STEREO OUT**

## Setting automatic monitoring

Input monitoring is possible when recording is enabled and the transport is stopped.

If automatic monitoring is ON, when playback starts, input sounds are muted, and only playback sounds can be monitored.

Use the **AUTO MONITOR** item to set this function.

### OFF (Default):

Input sounds are not muted even when playback starts.

When recording is enabled, input and playback sounds are mixed.

### ON:

When playback starts, input sounds are muted.

When recording is enabled, only playback sounds can be heard.

## Setting the song name format

Use the **Song Name Type** item to set the format used for song names created by this unit to **WORD** (default) or **DATE**.

**WORD:** The characters set are used for the beginning of the song name.

Example (set to "TASCAM"): "TASCAM0001"

**DATE:** The date is used for the beginning of the song name.

Example (created on July 10, 2012): "201207100001"

### ■ Setting the WORD

When the **Song Name Type** on the **PREFERENCE** screen is set to **WORD**, press the **F4** (▶) button to open the setting screen.

The length of the word is limited to XX single-byte alphanumeric characters. (See "Editing names" on page 30.)

## Restoring the initial preference settings

You can restore the **PREFERENCE** screen settings to the initial adjustments (factory default settings). This operation is called initialization.

1. When the recorder is stopped, press the **MENU** button to open the **MENU** screen.
2. Use the **JOG/DATA** dial or the **CURSOR** (▲/▼/◀/▶) buttons to select (green highlight) **PREFERENCE**, and then press the **F4** (▶) button.



The **PREFERENCE** screen appears.

3. Use the **CURSOR** (▲/▼) buttons to select **Initialize**, and then press the **F4** (▶) button.

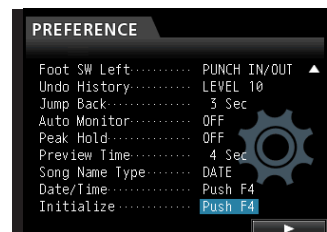

4. As a confirmation message appears, press the **F2** (YES) button to confirm.

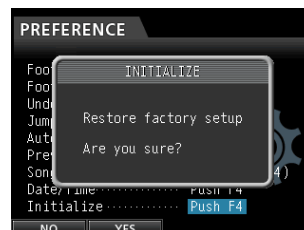

5. Once the initialization is completed, the display returns to the **PREFERENCE** screen.

### NOTE

*If you want to cancel the initialization, press the **F1** (NO) button.*

6. After making the settings, press the **HOME** button to return to the Home screen.

# 11 - Various Other Functions

## Viewing information

You can view information about the current song (currently loaded song), the SD card and the firmware.

1. When the recorder is stopped, press the **MENU** button to open the MENU screen.
2. Use the **JOG/DATA** dial or the **CURSOR** (▲/▼/◀/▶) buttons to select (green highlight) **INFORMATION**, and then press the **F4** (▶) button.



The **INFORMATION** screen appears.

The following information is displayed on the **INFORMATION** screen.

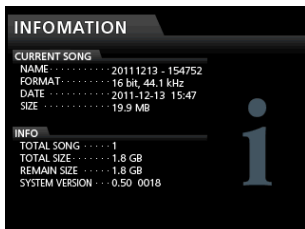

### CURRENT SONG

NAME  
FORMAT  
DATE  
SIZE

### INFO

TOTAL SONG  
TOTAL SIZE  
REMAIN SIZE  
SYSTEM VERSION



# 12 - SD Card Management

The recording files are stored on the SD cards.

Depending on the SD card capacity, the card is formatted with the FAT16 or FAT32 file system.

SD card capacity	File system
512MB to 2GB	FAT16
Above 2GB	FAT32

Moreover, this unit is compatible with SD card write protect function, so you can write-protect your cards to prevent accidental deletions by formatting them. (See "About write-protected SD cards" on page 26.)

When an SD card is inserted, the unit performs a mounting process and then enables the SD card use. At this time, if the inserted SD card has not been formatted by this unit, a message appears prompting you to format it.

If the inserted SD card has no setup files stored in it, a message appears prompting you to create a setup file.

When an SD card is ejected, the unit performs an unmount process and then a No Card message appears.

## CAUTION

- The ejection during recording is not supported.
- The format operation cannot be undone.

## NOTE

- The FAT (File Allocation Table) format is a disk format that can be read by a computer.
- SD and SDHC cards that are at least 512MB in size can be used.  
A list of SD cards that have been confirmed for use with this unit can be found on our web site.  
Please access to a product page of this product from the TEAC Global Site (<http://teac-global.com>) to find the list or contact the TASCAM customer support service.

## Quick formatting an SD card

Use the QUICK FORMAT item to quickly format an SD card. Using QUICK FORMAT erases all files on the card and automatically creates new MUSIC, UTILITY, and AudioDepot folders, as well as the dp-24.sys file that is necessary to use the SD card with this unit.

### CAUTION

*This operation erases all the data from the SD card. This operation cannot be undone.*

*Confirm that you will not lose important data before quick formatting a card.*

1. When the recorder is stopped, press the **MENU** button to open the MENU screen.
2. Use the **JOG/DATA** dial or the **CURSOR** (▲/▼/◀/▶) buttons to select (green highlight) **FORMAT**, and then press the **F4** (▶) button.

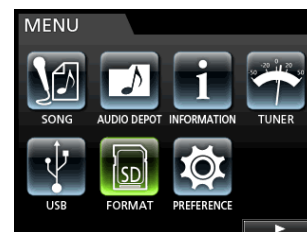

The Quick Format/Full Format selection screen appears.

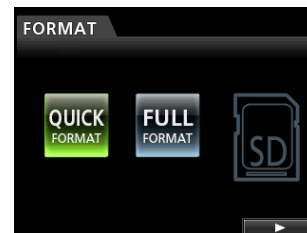

3. Use the **JOG/DATA** dial to select **QUICK FORMAT** and press the **F4** (▶) button.  
A confirmation message (**QUICK FORMAT**) appears.

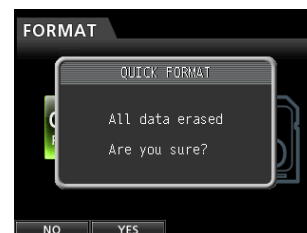

4. Press the **F2** (YES) button to execute the quick format. If you want to cancel the quick format, press the **F1** (NO) button.
5. Once the quick format is completed, the display returns to the **FORMAT** screen.

### NOTE

*When a card is formatted, a song is automatically created in the MUSIC folder.*

# 12 - SD Card Management

## Full formatting an SD card

Use the **FULL FORMAT** item to full format an SD card. Using **FULL FORMAT** erases all files on the card and automatically creates new **MUSIC**, **UTILITY**, and **AudioDepot** folders, as well as the **dp-24.sys** file that is necessary to use the SD card with this unit.

With Full Format, memory errors are checked during the formatting. The full format takes longer than the quick format. This operation will execute the Full Format of an SD card.

### CAUTION

*This operation erases all the data from the SD card. This operation cannot be undone.*

*Confirm that you will not lose important data before full formatting a card.*

1. When the recorder is stopped, press the **MENU** button to open the **MENU** screen.
2. Use the **JOG/DATA** dial or the **CURSOR** (**▲**/**▼**/**◀**/**▶**) buttons to select (green highlight) **FORMAT**, and then press the **F4** (**▶**) button.

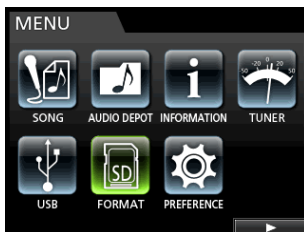

The Quick Format/Full Format selection screen appears.



3. Use the **JOG/DATA** dial to select **FULL FORMAT** and press the **F4** (**▶**) button.  
A confirmation message (**FULL FORMAT**) appears.



4. Press the **F2** (**YES**) button to execute the full format. If you want to cancel the full format, press the **F1** (**NO**) button.
5. Once the full format is completed, the display returns to the **FORMAT** menu screen.

### NOTE

*When a card is formatted, a song is automatically created in the **MUSIC** folder.*

# 13 - Exchanging Data with a Computer

By connecting this unit to a computer using a commercially-available USB cable, you can backup song data from an SD card in the unit to a computer and restore backed-up song information. In addition, you can export track files and stereo master files from songs to the computer, as well as import audio files from the computer to the unit.

Backed up data can be restored to a different DP-24SD unit than the one that created it. In other words, files can be freely exchanged between DP-24SD units, making it easy to add additional recordings or mix existing recordings in a different location.

## CAUTION

*If you want to remove an SD card from this unit and back up its data on a computer using a card reader, always turn off the unit's power before removing the card.*

## NOTE

*In this chapter, "computer" refers to a Windows or Mac personal computer connected to this unit. (See "Operating system requirements" on the right column.)*

The following types of data can be transferred from this unit to a computer.

### ■ Entire songs

You can transfer the data for an entire song from the unit's MUSIC folder to a computer. This operation is called "backup". In addition, data backed up on a computer can be transferred to the MUSIC folder, and then restored as song file. This operation is called "restore".

### ■ WAV format tracks

Export specified track files as WAV files to the AudioDepot folder of the SD card. In addition, you can import specified track files by storing WAV files from a computer to the AudioDepot folder beforehand.

In other words, the data transfer between the computer and track files is carried out through the AudioDepot folder.

### ■ Master file

A master file created on this unit can be transferred to a computer as a stereo WAV file (from the "Song name" folder inside the MUSIC folder).

Only export of the master file is possible.

## Operating system requirements

You can connect this unit to computers with the following operating systems.

### ■ Windows

Windows 8 (including 8.1)  
Windows 7  
Windows Vista  
Windows XP

### ■ Mac OS X

OS X Yosemite (10.10)  
OS X Mavericks (10.9)  
OS X Mountain Lion (10.8)  
OS X Lion (10.7)  
Mac OS X Snow Leopard (10.6)

When this unit is connected to a computer, the computer recognizes it as a removable disk. There is no need for a special driver.

## NOTE

*Data transfer between this unit and a computer occurs at USB 2.0 speed (maximum). Data can still be transferred if the computer connection is USB 1.1, but it will be slower. In addition, to assure USB 2.0 speed, use a cable that meets USB 2.0 standards.*

## Connecting to a computer

When connected via USB, this unit's record, playback and other recorder operations cannot be used.

To connect with a computer, connect the USB port on the rear panel of the unit with a USB port on the computer using a mini-B-type USB 2.0 cable.

It does not matter whether you turn the unit's power ON before or after the USB connection is made.

When this unit is ON, enable the USB connection in the USB item of the MENU screen.

The currently loaded song is saved before the USB connection becomes effective. When connected, the following screen appears on the display.



After making a USB connection, you must turn the power on and enable the USB connection in the USB item of the MENU screen.

This unit appears as an external drive named DP-24SD on the computer's display.

Clicking on the DP-24SD drive will display the MUSIC, UTILITY, and AudioDepot folders.

## CAUTION

- *Be sure to use the included PS-P1220E AC adapter to supply power to this unit. Power cannot be supplied to this unit via USB.*

# 13 - Exchanging Data with a Computer

- Do not disconnect the AC adapter or otherwise cut the power to the unit during data transfer. Doing so will cause all the data to be lost. This lost data cannot be restored.
- Do not change the folder names inside the DP-24SD.

## NOTE

The **UTILITY** folder is used to, for example, update the system software used by the unit. In addition, do not change the names or delete individual files contained in the **Song** folder inside the **MUSIC** folder. There is no problem if you delete a **Song** folder as a whole.

## Disconnecting

Follow the procedure below to disconnect the USB connection correctly.

## CAUTION

When transferring data, do not disconnect the unit or remove the USB cable. Doing so could cause data on the computer or this unit to be damaged.

## NOTE

When disconnecting from a computer, the procedure on the computer might be called "eject", "unmount" or "remove".

### ■ Disconnecting from Windows computers

When using Windows 8 (including 8.1), Windows 7, Windows Vista or Windows XP, follow the procedures below to disconnect.

A PC card icon and arrow appear in the taskbar (usually at the bottom right of the screen).

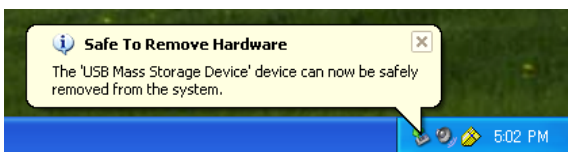

1. Left click on this icon to open a pop-up bar. Click on this pop-up bar to disconnect this unit from the computer.
2. After a message appears on the computer screen saying that this unit can be disconnected, press the applicable function key to disconnect this unit and the computer. After that, you can unplug the USB cable.

The Home screen appears on the display.

## CAUTION

If a message appears on the computer screen saying that this unit cannot be disconnected safely, do not disconnect the USB cable.

Close all the computer programs and windows that are accessing files on this unit, and then try the operation again.

### ■ Disconnecting from Mac computers

1. Drag the DP-24SD icon that represents this unit to the Trash, or use Command + E to eject the DP-24SD.

## TIP

Depending on the OS version or OS settings you might also be able to eject the DP-24SD icon by clicking on an eject icon next to it in the Finder window or by using a control key.

2. After the DP-24SD icon disappears from the display, press the function key to disconnect this unit and the computer. After that, you can unplug the USB cable.

The Home screen appears on the display.

## Track import and export

You can import and export individual tracks between a computer and this unit's by using the **AudioDepot** folder.

Files that can be imported/exported as tracks must be WAV files (with the ".WAV" extension).

You can import both mono and stereo files, and export mono files.

If you want to import an audio file of a different format into this unit, you must convert it to a WAV file first.

## Importing tracks

1. Connect the unit to a computer. (See "Connecting to a computer" on page 67.)
2. Operate the computer to copy WAV files to the **AudioDepot** folder of this unit.

## NOTE

The files to be copied must have single-byte alphanumeric character names.

If you try to copy a file named in Japanese characters, as the file name does not appear on the display in step 6 below, it cannot be imported.

3. Disconnect properly the unit from the computer, and then unplug the USB cable. (See "Disconnecting" on page 68.)
4. Press the **MENU** button to open the **MENU** screen.
5. Use the **JOG/DATA** dial or the **CURSOR** (▲/▼/◀/▶) buttons to select (green highlight) **AUDIO DEPOT**, and then press the **F4** (▶) button.



The WAV files that can be imported appear.

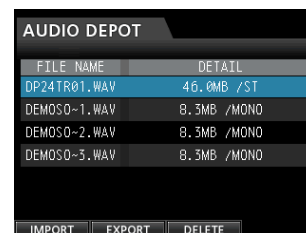

# 13 - Exchanging Data with a Computer

- Use the **JOG/DATA** dial or the **CURSOR** (**▲**/**▼**) buttons to select the WAV file that you want to import, and then press the **F1** (**IMPORT**) button.

Empty tracks that can be imported appear.

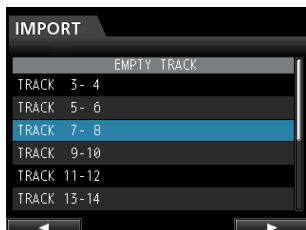

## NOTE

- If you are trying to import a WAV file whose attribute does not match the current song attribute, an error pop-up message appears. For example, the current song attribute is 44.1 kHz, but you are trying to import a 48 kHz WAV file. When there is no file that can be imported, **FILE NOT FOUND** appears.
  - When the file name is short, spaces appear after the file name, but those spaces are not included in the actual file name.
- Use the **JOG/DATA** dial or the **CURSOR** (**▲**/**▼**) buttons to select the track to be imported, and then press the **F4** (**▶**) button.

A confirmation message appears.



## NOTE

When the WAV file to be imported is stereo, you must select a track pair.

- Press the **F2** (**YES**) button to execute the import. Import starts.

## NOTE

- If there is not enough space or the file format is wrong, an error message appears.
  - The beginning of the file is set at the start of the song (00:00:00:00). In the same way as other recording tracks, you can edit the track that has received the imported file. (See "8 - Track Editing" on page 49.)
  - To import a stereo WAV file, an empty stereo track is necessary.
- Once the import is completed and a pop-up window is displayed, the display returns to the **Audio Depot** screen.
  - Press the **HOME** button to return to the Home screen.

## Exporting tracks

- When the recorder is stopped, press the **MENU** button to open the **MENU** screen.
- Use the **JOG/DATA** dial or the **CURSOR** (**▲**/**▼**/**◀**/**▶**) buttons to select (green highlight) **AUDIO DEPOT**, and then press the **F4** (**▶**) button.
- Press the **F2** (**EXPORT**) button.

The **EXPORT** screen appears showing a list of tracks that contain stored audio.

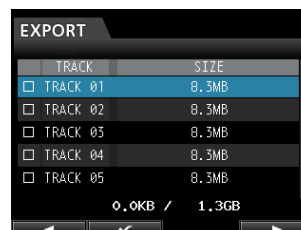

## NOTE

Song tracks that do not have audio recordings are not displayed in the file list.

- Use the **JOG/DATA** dial to select (blue highlight) the track that you want to export, and then press the **F2** (**✓**) button. A check mark **✓** appears in the check box next to the selected track.

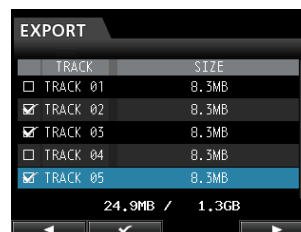

By checking multiple check boxes (**✓**), you can export more than one track at once.

## NOTE

To remove the check mark **✓** from a check box, press the **F2** (**✓**) button again while the track is selected (blue highlight).

- When you finish putting checks (**✓**) next to the tracks that you want to export, press the **F4** (**▶**) button. A confirmation message appears.

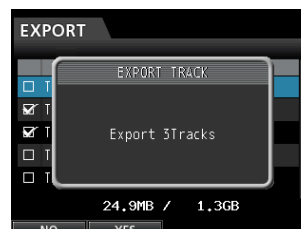

- Press the **F2** (**YES**) button to export the selected track to the **AudioDepot** folder.

## NOTE

When a track file with the same name already exists in the **AudioDepot** folder, a number is added to the file name end, so the track is not overwritten.

- After the pop-up message appears, the display returns to the **Audio Depot** screen.
- Press the **HOME** button to return to the Home screen.
- Connect the unit to a computer. (See "Connecting to a computer" on page 67.)

## 13 - Exchanging Data with a Computer

10. Operate the computer to copy track files from the AudioDepot folder of the SD card to the computer.
11. After exporting track files to the computer, disconnect the unit from the computer using the proper procedures, and then unplug the USB cable. (See "Disconnecting" on page 68.)

---

### Deleting files from the AudioDepot folder

---

1. When the file list is displayed, use the **JOG/DATA** dial or the **CURSOR** (**▲** / **▼**) buttons to select the files that you want to delete.
2. Press the **F3** (**DELETE**) button, which will cause a confirmation message to appear.



3. Press the **F2** (**YES**) button to execute the deletion. When you want to delete multiple files, repeat the procedure above.

# 14 – Troubleshooting

When working with this unit, if something is not going the way you want, or if you experience any difficulties, etc., first refer to this troubleshooting section. It contains the most common troubles, the probable causes, and the corrective measures. Also, see “15 – Messages” on page 72 for the meaning of messages that may pop up on the display. Consult this table when a message appears when an operation cannot be completed by the unit.

## The SD card is not recognized.

- Confirm that the SD card is completely inserted.

## Why can't I hear any sound when I play back?

- Are the track faders of the tracks set to a proper level?
- Is the **STEREO** fader set to a proper level?
- Have you connected the **PHONES** or **MONITOR OUT** jack to your monitoring system properly?  
Is your monitoring system set up correctly?
- Is the **MONITOR LEVEL** knob set to a proper level?  
(**PHONES** jack only)

## The sound I am trying to record sounds distorted.

- Aren't the **INPUT A** to **H TRIM** knobs on the top panel of the unit set too high?  
Isn't the input source too loud?
- Isn't the monitoring system distorted because the monitor level is too high?

## Why can't I record?

- You must have at least one track in recording standby (**REC** indicator flashing) before you start recording by pressing the **RECORD** (●).
- Are input sources assigned to tracks? (See “Assigning inputs” on page 35.)

## Noise occurs if I connect a passive guitar or bass directly.

- Connecting another device to the unit's stereo output (**STEREO OUT**) jacks might reduce the noise.
- This might be caused by interference noise from another device. If there is a power amplifier or other device that uses a large transformer, a fluorescent light or something similar nearby, you might be able to reduce the noise by changing the distance and orientation of this unit in relation to such equipment.

## The unit turns off.

- This product is compliant with the European ErP standby power regulations. In order to comply with these regulations, the automatic power saving function is set to 30 minutes when the unit is shipped from the factory. So, by default, the unit will turn off automatically after 30 minutes elapse without any operation. Change the automatic power saving function setting if you want to disable it. (See “Setting automatic power saving” on page 63.)

# 15 – Messages

## General messages

The following list shows the messages that may pop up during the use of the unit.

These messages alert you to conditions that may arise while you are using the unit. Consult the table below if you see something you do not understand or if you want to know how to solve a problem.

Message	Description and remedy
Can not Import	This pop-up appears when the Sample Rate or Sample Bit of the selected file in the AUDIO DEPOT-IMPORT menu differs from the current song.
Cannot Clear Current	The current track cannot be deleted. A virtual track assigned to a physical track cannot be deleted.
Card Error	The card could not be handled properly. Replace the card.
Card Full	The card has no remaining capacity. Erase unnecessary files or move them to your computer to make open space.
Empty Export Track	You tried to export a track that does not contain any recording data. This pop-up appears if you try to export a song track that does not contain any recording. (See “Exporting tracks” on page 69.) Export a song track that has been recorded.
Export File Too Big	The track to be exported exceeds the SD card available capacity. You have tried to export a track to the AudioDepot folder, but the size is too large for the remaining space on the SD card. Delete unnecessary songs or files from the AudioDepot folder to create more space on the SD card, then try to export the track again.
File Not Found	File to be imported could not be found. You tried to import a WAV file from the AudioDepot folder, but there is no WAV files in it. (See “Importing tracks” on page 68.) Connect the unit to a computer and transfer the files that you want to import from the computer to the AudioDepot folder of the unit.
Format Error Format CARD	The formatting of the card is abnormal or corrupted. This message also appears if you formatted the card for FAT format using a computer connected via USB and if an unformatted card is inserted in the unit. Always use the DP-24SD to format cards to be used with it. Replace the card or format the card using the FORMAT menu. Execution of FAT formatting erases all data currently on the card.
I/O Too Short	Interval between IN and OUT points is too short. You tried to enter repeat mode, but the time between the IN and OUT points is too short.
Import Failed Export Failed	Import or export failed.
Import File Too Large	Size of file to be imported is too big. You tried to import a WAV file from the AudioDepot folder that is too large for the remaining space on the SD card. Free up some space in the AudioDepot folder by deleting unnecessary songs, and try again.
In Bounce Mode	Bounce mode is active. You tried to perform an action that cannot be done while in Bounce mode.
In Master Mode	Mastering mode is active. You tried to perform an action that cannot be done while in Mastering mode.
In Punch Mode	Auto Punch mode is active. You tried to perform an action that cannot be done while in Auto Punch mode.
In Repeat Mode	Repeat Playback mode is active. You tried to perform an action that cannot be done while in Repeat Playback mode.
Invalid Card	The format of the inserted SD card cannot be used in this unit. Insert another SD card after turning off the unit, or format the card using FORMAT on the MENU screen.
Invalid Card Change Card	Something might be wrong with the card. Replace the card.
Mark Full	It is not possible to register more location marks. You tried to store more than 99 location marks in a song. (See “Location marks” on page 44.) Delete some location marks and try again.
Master File Not Found	Master file could not be found. This message appears if you try to enter Mastering mode, but you have not made any mixdown recording yet. First perform a mixdown recording.
Master Track Too Large	The master file is too large. You tried to create a master file that is larger than the remaining available space on the SD card. Format the SD card (see “Quick formatting an SD card” on page 65 and “Full formatting an SD card” on page 66), or connect the unit to a computer and delete unnecessary files to create available space in the card.
MBR Error Init CARD	The formatting of the card is abnormal or corrupted. Replace the card or format the card using the FORMAT menu. Execution of formatting erases all data currently on the card.
No Card	No SD card is in the unit. Load a recordable SD card.



No Armed Track	There is no track in recording standby. You tried to enter auto punch mode or press the <b>RECORD</b> button when no tracks were in record standby. (See “Automatic punching in and out” on page 46.) Put a track into record standby before pressing the <b>RECORD</b> button or entering the auto punch mode.
No Undo History	There is no undo history. There are no actions to be undone. (See “Undoing an operation” on page 40.)
Not Stopped	The recorder is not stopped. When the recorder is not stopped, this message appears when you press a button that works only when the recorder is stopped, such as the <b>UNDO/REDO</b> button, etc.
OUT point must be set after the IN point.	You cannot set the OUT point before the IN point. Set the OUT point after the IN point.
Protected Card	The inserted SD card is write-protected. To record or edit, turn off the unit and unprotect the SD card.
Recorded Track Not Found	During execution of the export menu, the current song has no tracks recorded in it. No tracks are recorded in the current song, or virtual tracks are not assigned to physical tracks. Select a recorded song, assign the track you want to export to a physical track, and then export it. (See “Virtual tracks” on page 48.)
Revert to discard changes.	Editing and changes made from when loaded will be cleared, and reset to the same status as when loaded. Proceed only when you are sure you wish to clear these changes.
Same Track	The same track has been specified. This message appears in the clone track setting, when the same track is specified.
Song Protected	The song is protected. The song is protected and you are trying to change it (record, edit, etc.). (See “Protecting songs” on page 33.) Unprotect the song.
Stereo Track Full	The stereo track is already recorded. This message appears if you try to import a stereo file when a stereo track is already recorded in the song.
Track Full	The track is already recorded. This message appears if you try to import a file when all tracks already have recordings. (See “Importing tracks” on page 68.)
Trk Edit Fail	Track edit failed. Save the song and turn the unit off and then on, and perform track edit again.
Trk Too Short	The track is too short. You are trying to start a record in mixdown mode, but the time between the IN and OUT points is too short. The IN and OUT points must be at least 4 seconds apart. (See “Setting IN/OUT points” on page 45.)
Turn off the Guitar Effect or use two or less Dynamic Effects.	While using a guitar effect, the use of dynamic effects is limited to only 1–2 channels. To use dynamic effects on 3 or more channels, turn the guitar effect OFF.
Virtual Track has different Track Type	Since a virtual track has been recorded, the track type cannot be changed. If you want to change it, clear the recorded virtual track.
Work Memory Full	The work memory is full. Even if the SD card has enough remaining space, this error may occur when you perform many editing operations. You may be able to continue the work if execute the <b>DELETE UNUSED</b> item of the <b>SONG</b> menu to increase the available space in the work memory. (See “Undoing an operation” on page 40.)

## 15 – Messages

Audio Rst Fail	<p>If any of these errors occur, turn the unit power off and restart it. If the error message continues to appear frequently, please contact the store where you purchased this unit or a TASCAM customer support service.</p>
Device Error	
File Error	
Not Continued	
Remote Cmd	
Remote Rx	
Sys Rom Err	
System Err 50	
System Error 1	
System Error 2	
System Error 3	
System Error 4	
System Error 5	
System Error 6	
System Error 7	
System Error 8	
System Error 9	
Writing Failed	

# 16 – Specifications

---

## Ratings

---

### Recording media

- SD card (512 MB to 2 GB)
- SDHC card (4 GB to 32 GB)

### File system

- SD card (512 MB to 2 GB) : FAT16
  - SDHC card (4 GB to 32 GB) : FAT32
- 

## Input/output ratings

---

### Analog audio input/output ratings

#### INPUT A to H jack

- **XLR type (Balanced)**

- Connector: XLR-3-31 (1 : GND, 2 : HOT, 3 : COLD)
- Input impedance: 2.4 k $\Omega$
- Rated input level: -14 dBu
- Maximum input level: +2 dBu

- **Standard jack type (Balanced)**

- Connector: 6.3 mm (1/4") TRS standard jack
- Input impedance:
  - Above 22 k $\Omega$
  - 1 M $\Omega$  (INPUT H only, when **LINE-GUITAR** switch is set to **GUITAR**)
- Rated input level: +4 dBu
- Maximum input level: +20 dBu

#### STEREO OUT jack

- Connector: RCA pin jack
- Rated output level: -10 dBV
- Maximum output level: +6 dBV
- Output impedance: 200  $\Omega$

#### EFFECT SENDS jack

- Connector: 6.3 mm (1/4") TS standard jack
- Rated output level: -10 dBV
- Maximum output level: +6 dBV
- Output impedance: 200  $\Omega$

#### MONITOR OUT jack

- Connector: 6.3 mm (1/4") TRS standard jack
- Rated output level: -2 dBu
- Maximum output level: +14 dBu
- Output impedance: 200  $\Omega$

#### PHONES jack

- Connector: 6.3 mm stereo jack
- Maximum output level: 70 mW+70 mW or more (THD+N 0.1% or less, 32  $\Omega$  load)

---

## Control input/output ratings

### USB port

- Connector: USB 4-pin mini-B type
- Format: Mass Storage Class USB 2.0 HIGH SPEED

### REMOTE jack

- Connector: 2.5 mm TRS jack
- 

## Audio performance

---

### Frequency response

- INPUT (MIC/LINE) → STEREO OUT/EFFECT SENDS/MONITOR
- OUT: 20 Hz to 20 kHz, +1 dB/-1 dB

### Distortion

- INPUT (MIC/LINE) → STEREO OUT/EFFECT SENDS/MONITOR
- OUT: 0.01% or less

### S/N ratio

- INPUT (MIC/LINE) → STEREO OUT/EFFECT SENDS/MONITOR
  - OUT: 90 dB or more
- 

## Operating requirements

---

See the TEAC Global Site (<http://teac-global.com/>) for updated information about OS compatibility.

### Windows

- Pentium 300 MHz or faster
- 128 MB or more memory
- USB port (USB 2.0 recommended)

### Mac

- Power PC, iMac, G3, G4 266 MHz or faster
- 64 MB or more memory
- USB port (USB 2.0 recommended)

### Recommended USB host controller

- Intel chipset

### Supported OS

#### Windows:

- Windows 8 (including 8.1)
- Windows 7
- Windows Vista
- Windows XP

#### Macintosh:

- OS X Yosemite (10.10)
- OS X Mavericks (10.9)
- OS X Mountain Lion (10.8)
- OS X Lion (10.7)
- Mac OS X Snow Leopard (10.6)

# 16 – Specifications

## General

### Power supply

AC adapter (PS-P1220E)

514 x 100.4 x 336.9 mm (Width x Height x Depth, excluding projections)

### Power consumption

12 W (Phantom power ON)

### Weight

6.2 kg/13.67 lb

### Dimensions

### Operating temperature range

5 to 35°C/41 to 95°F

## Dimensional drawings

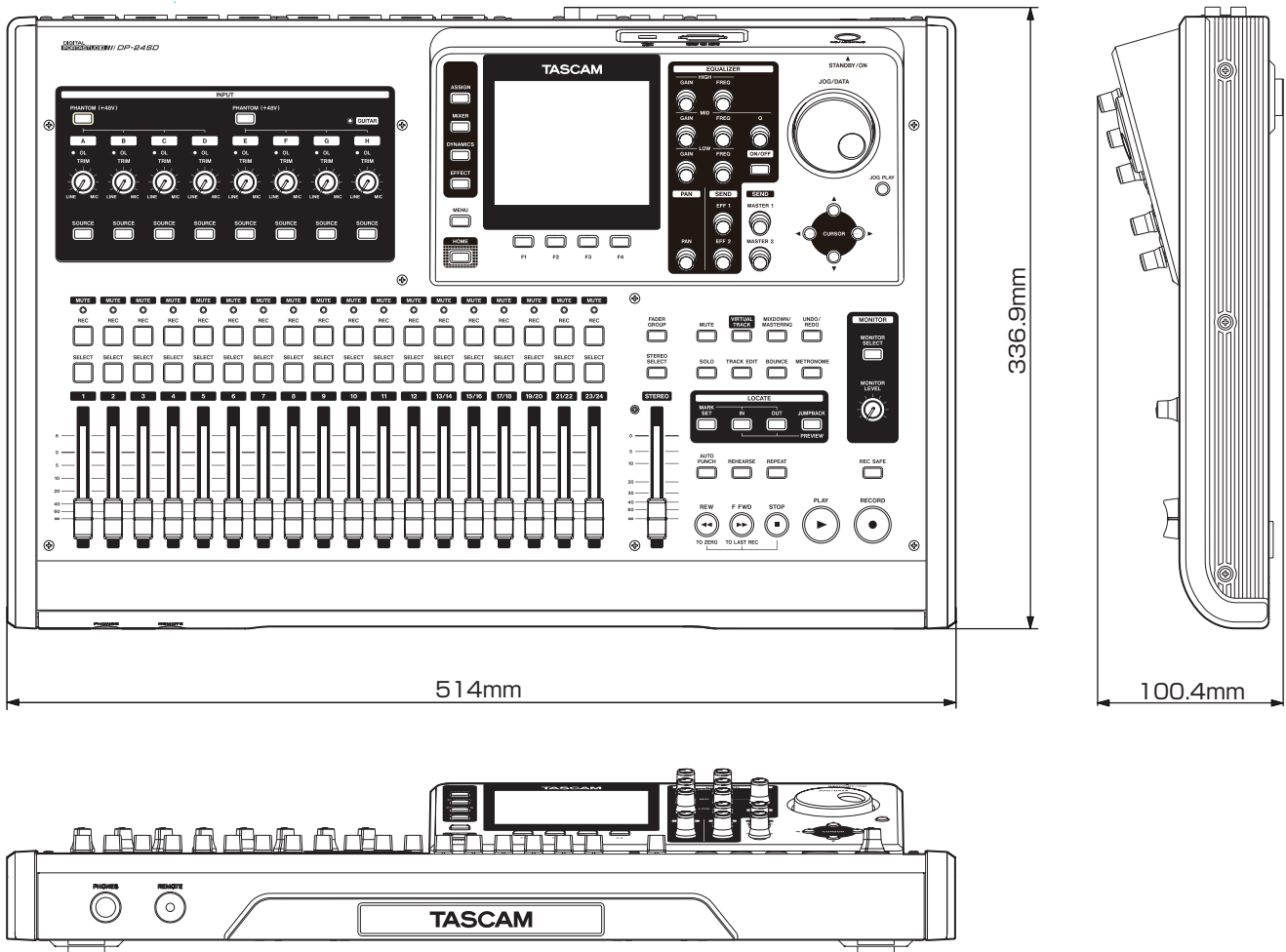

\* Illustrations in this manual may differ from the actual product.

\* In order to improve the product, specifications and appearance could be changed without prior notice.

## Block diagram

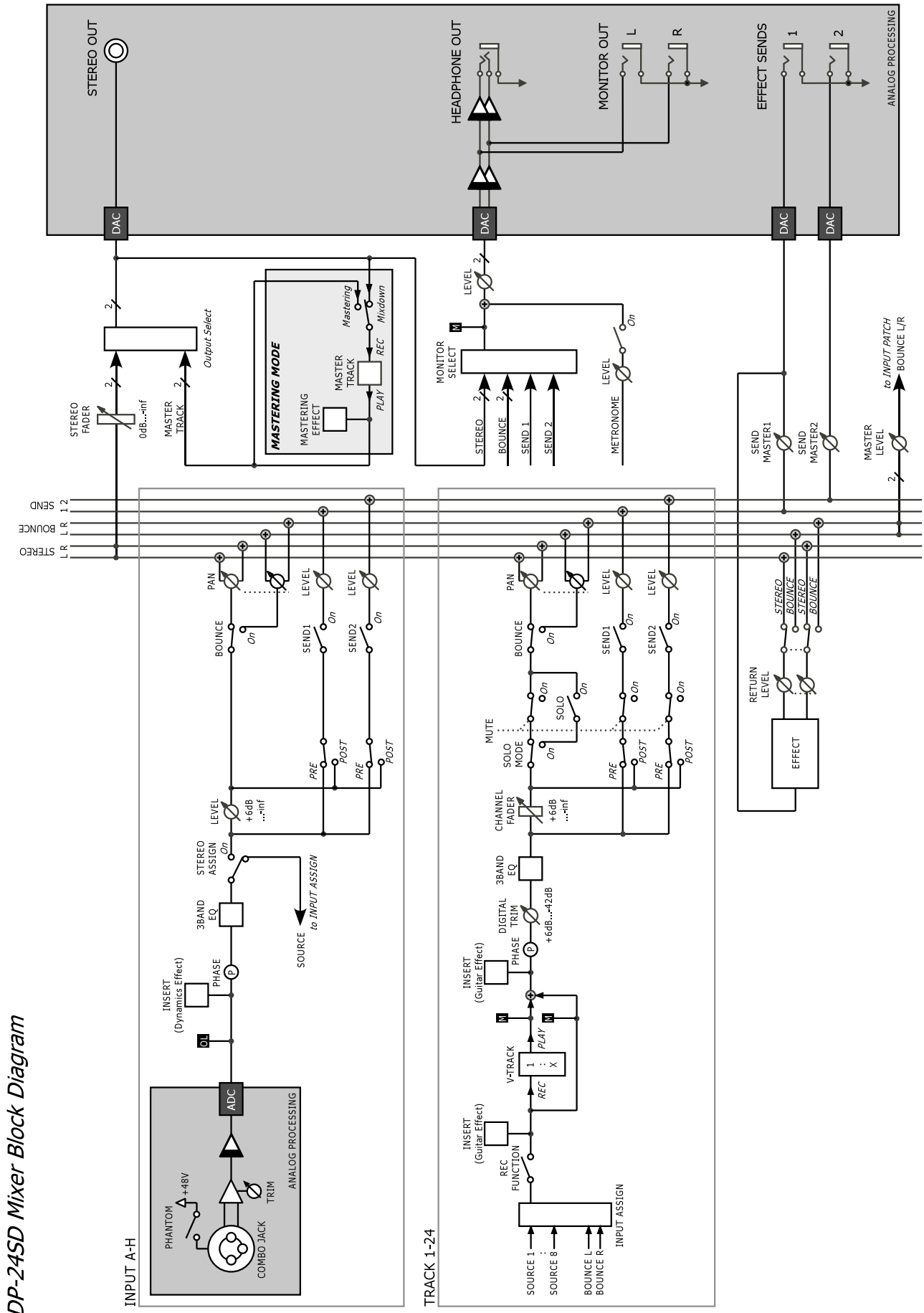

DP-24SD Mixer Block Diagram

# 16 - Specifications

## Level diagram

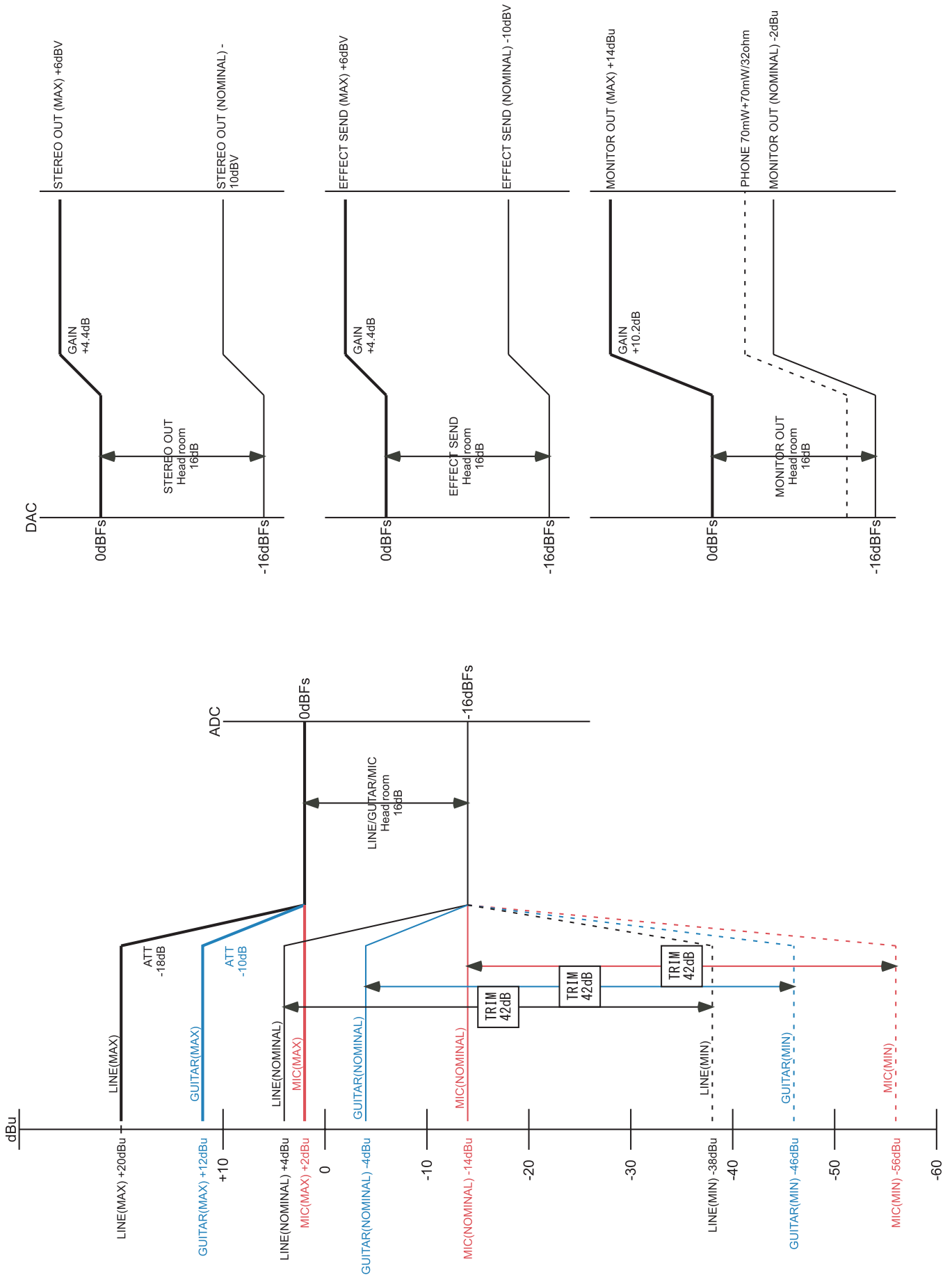

## WARRANTY

### < In the United States >

This warranty gives you specific legal rights and you may also have other rights which vary from state to state. This warranty is only valid within the country the unit was originally purchased.

#### WHAT IS AND IS NOT COVERED

Except as specified below, this warranty covers all defects in materials and workmanship in this product. The following are not covered by the warranty:

1. **Damage to or deterioration of the external cabinet.**
2. **Damages resulting from accident, misuse, abuse or neglect.**
3. **Damage resulting from failure to perform basic daily maintenance and/or calibration or otherwise resulting from failure to follow instructions contained in your owner's manual.**
4. **Damage occurring during shipment of the product. (Claims must be presented to the carrier)**
5. **Damage resulting from repair or attempted repair by anyone other than TEAC or an authorized TASCAM service station.**
6. **Damage resulting from causes other than product defects, including lack of technical skill, competence, or experience of the user.**
7. **Damage to any unit which has been altered or on which the serial number has been defaced, modified or is missing.**

#### WHO IS COVERED UNDER THE WARRANTY

This warranty may be enforced only by the original purchaser. This warranty is not valid if the product was purchased through an unauthorized dealer.

#### LENGTH OF WARRANTY

All parts except heads and disk drives are warranted for one (1) year from the date of original purchase. Heads and disk drives are warranted to ninety (90) days from date of original purchase. Labor is warranted for ninety (90) days from date of original purchase.

### WHAT WE WILL PAY FOR

We will pay all labor and material expenses for items covered by the warranty. Payment of shipping charges is discussed in the next section of this warranty.

#### HOW YOU CAN GET WARRANTY SERVICE

Your unit must be serviced by an authorized TASCAM service station in the United States. (This warranty is not enforceable outside the U.S.) If you are unable to locate an authorized TASCAM service station in your area, please contact us. We either will refer you to an authorized service station or instruct you to return the unit to the factory. Whenever warranty service is required, you must present a copy of the original dated sales receipt from an Authorized TASCAM Dealer.

You must pay any shipping charges if it is necessary to ship the product to service. However, if the necessary repairs are covered by the warranty, we will pay return surface shipping charges to any destination within the United States.

#### LIMITATION OF IMPLIED WARRANTIES

Any implied warranties, INCLUDING WARRANTIES OF MERCHANTABILITY AND FITNESS FOR A PARTICULAR PURPOSE, are limited in duration to the length of this warranty.

#### EXCLUSION OF DAMAGES

TEAC's liability for any defective product is limited to repair or replacement of the product, at TEAC's option. TEAC shall not be liable for:

1. **Damages based upon inconvenience, loss of use of the product, loss of time interrupted operation or commercial loss; or**
2. **Any other damages, whether incidental, consequential or otherwise.**

Some states do not allow limitations on how long an implied warranty lasts and/or do not allow the exclusion or limitation of incidental or consequential damages, so the above limitations and exclusions may not apply to you.

#### To locate an Authorized Service Center in Your Area

CALL 1-800-447-8322

### < Europe >

This product is subject to the legal warranty regulations of the country of purchase. In case of a defect or a problem, please contact the dealer where you bought the product.

Ce produit est sujet aux réglementations concernant la garantie légale dans le pays d'achat. En cas de défaut ou de problème, veuillez contacter le revendeur chez qui vous avez acheté le produit.

Dieses Gerät unterliegt den gesetzlichen Gewährleistungsbestimmungen des Landes, in dem es erworben wurde. Bitte wenden Sie sich im Gewährleistungsfall an den Händler, bei dem sie das Gerät erworben haben.

Questo apparecchio è conforme alle norme sulla garanzia vigenti nel rispettivo Paese in cui esso è stato acquistato. Si prega di rivolgersi al proprio commerciante, presso il quale è stato acquistato l'apparecchio, nel caso in cui si voglia richiedere una prestazione in garanzia.

Las condiciones de garantía de este aparato están sujetas a las disposiciones legales sobre garantía del país en el que ha sido adquirido. En caso de garantía, debe dirigirse al establecimiento donde adquirió el aparato.

### < In other countries/areas >

This warranty gives you specific legal rights, and you may also have other rights that vary by country, state or province.

If you have a warranty claim or request, please contact the dealer where you bought the product.

该保证书赋予了顾客特定的合法权利，并且因国家、州或省等地域的不同，顾客可能拥有其他权利。如需申请或要求保修，请与购买本产品的销售店进行联系。

If you require repair services for your TASCAM equipment, please contact the dealer where the product was purchased from or the TASCAM Distributor in your country. A list of TASCAM Distributors can be found on our website at: <http://teac-global.com/>

# TASCAM

## TEAC CORPORATION

Phone: +81-42-356-9143

1-47 Ochiai, Tama-shi, Tokyo 206-8530 Japan

<https://tascam.jp/jp/>

## TEAC AMERICA, INC.

Phone: +1-323-726-0303

1834 Gage Road, Montebello, California 90640 USA

<http://tascam.com/>

## TEAC UK LIMITED

Phone: +44-8451-302511

2 Huxley Road, Surrey Research Park, Guildford, GU2 7RE, United Kingdom

<http://tascam.eu/>

## TEAC EUROPE GmbH

Phone: +49-611-71580

Bahnstrasse 12, 65205 Wiesbaden-Erbenheim, Germany

<http://tascam.eu/>

## TEAC SALES & TRADING(SHENZHEN) CO., LTD

Phone: +86-755-88311561~2

Room 817, Block A, Hailrun Complex, 6021 Shennan Blvd., Futian District, Shenzhen 518040, China

<http://tascam.cn/>

## WARRANTY

Model/Modèle/Modell  
Modello/Modelo/型号

# DP-24SD

Serial No./No de Série/Seriennummer  
Numero di serie/Número de serie/序列号

# Sample

Date of purchase/Date de l'achat/Datum des Kaufs  
Data dell'acquisto/Fecha de compra/购买日期

Owner's name/Nom du possesseur/Name des Eigentümers  
Nome del proprietario/Nombre del propietario/顾客姓名

Address/Adresse/Adresse  
Indirizzo/Dirección/顾客地址

Dealer's name/Nom du détaillant/Name des Händlers  
Nome del commerciante/Nombre del establecimiento/销售店名

## TASCAM

<http://teac-global.com/>

Dealer's address/Adresse du détaillant/Adresse des Händlers  
Indirizzo del commerciante/Dirección del establecimiento/销售店地址