

OHIO SCIENTIFIC

product name/number **MODEL 470**
SINGLE SIDED FLOPPY INTERFACE

date 27 JUL 1979
DRAWN ~ J.L.K.

revision

page

status

sheet 1 of 5

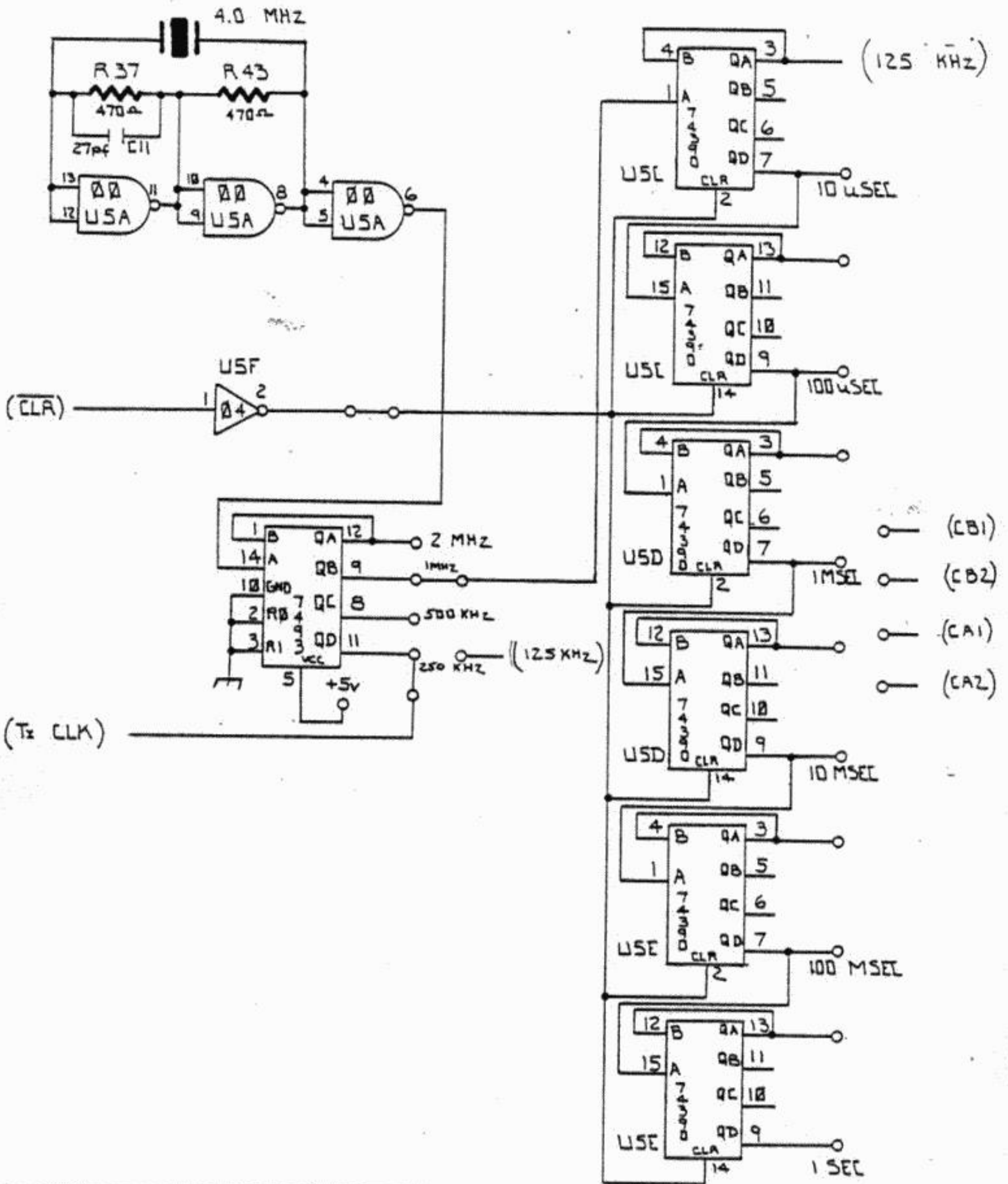

OHIO SCIENTIFIC

product name/number MODEL 470
SINGLE SIDED FLOPPY INTERFACE

date 27 JUL 1979

revision

page

status

sheet 2 of 5

DRAWN ~ J.L.K.

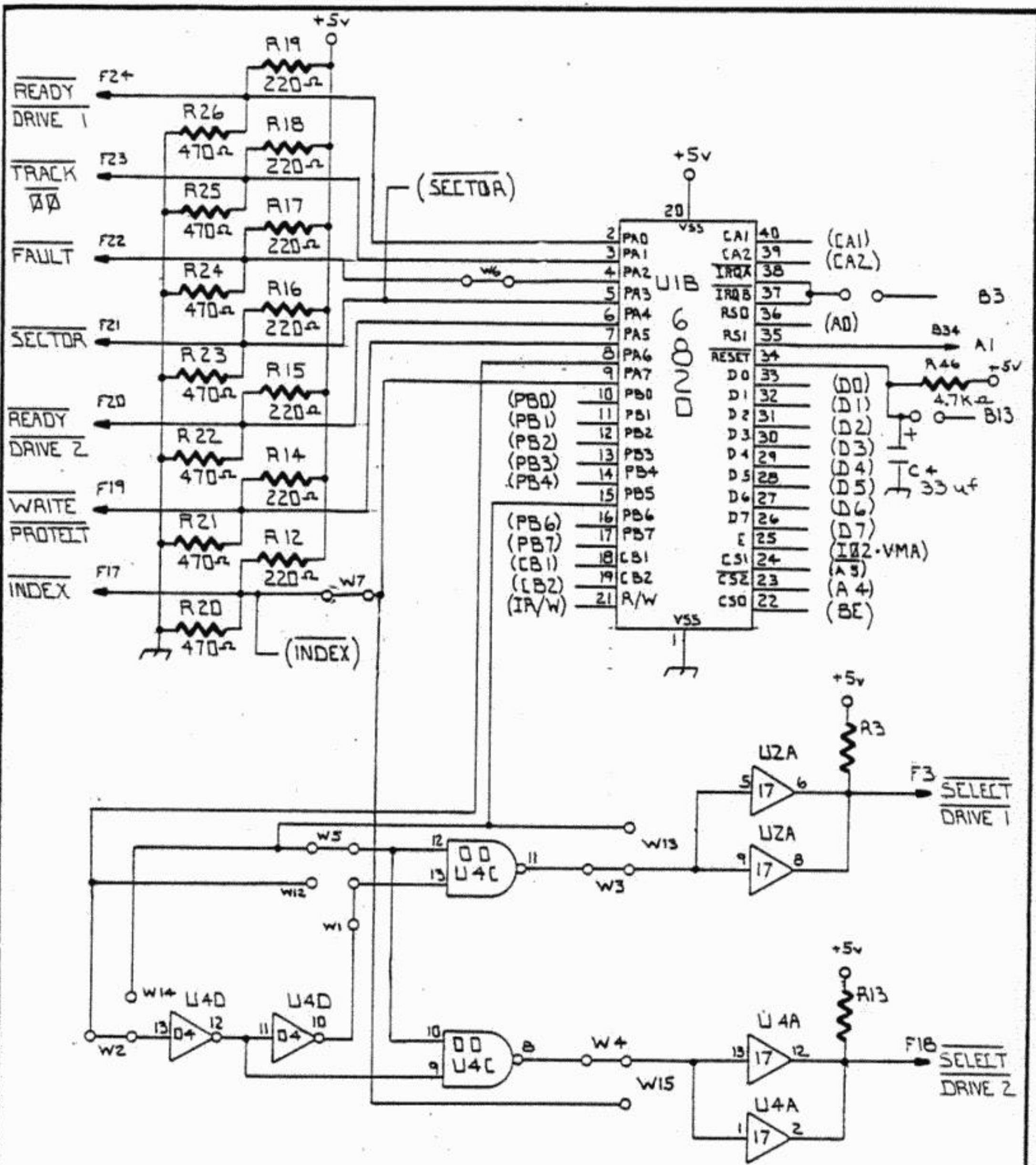

OHIO SCIENTIFIC

product name/number
MODEL 470
SINGLE SIDED FLOPPY INTERFACE

date 27 JUL 1979	revision	page	status	sheet 3 of 5
DRAWN ~ J.L.K.				

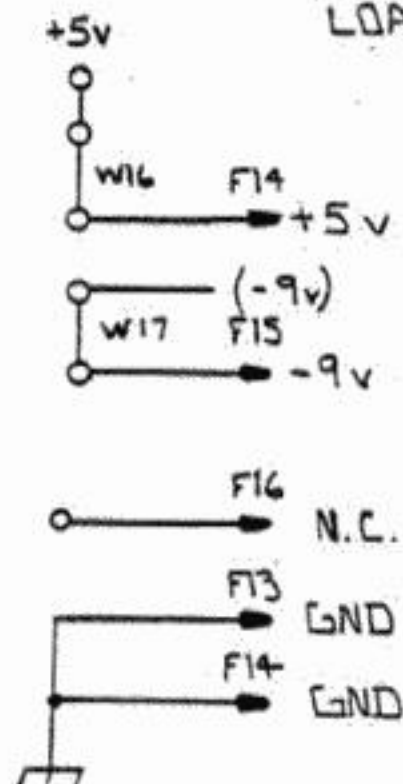
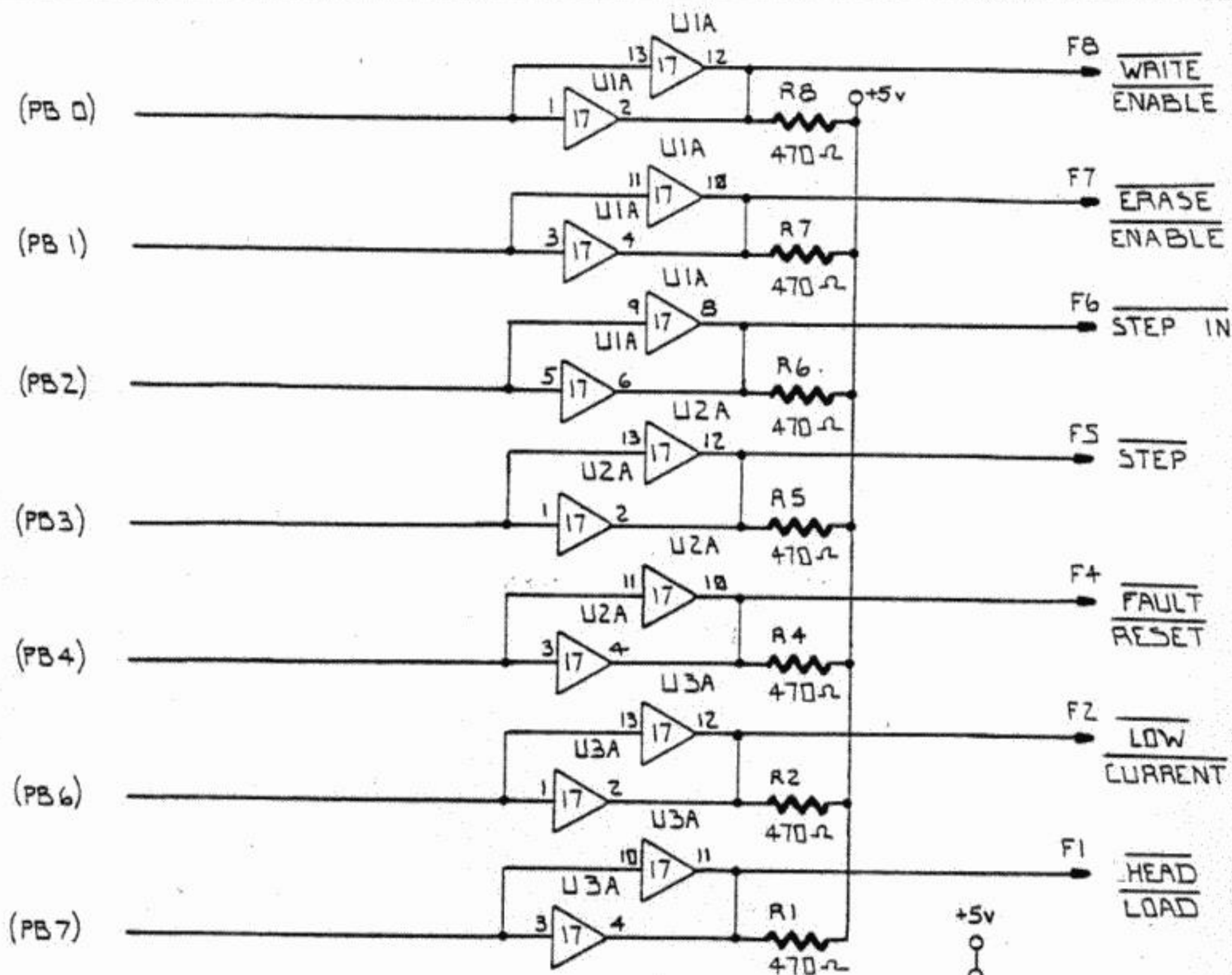

OHIO SCIENTIFIC

product name/number MODEL 470
SINGLE SIDED FLOPPY INTERFACE

date 27 JUL 1979

revision

page

status

sheet 4 of 5

DRAWN - J.L.K.

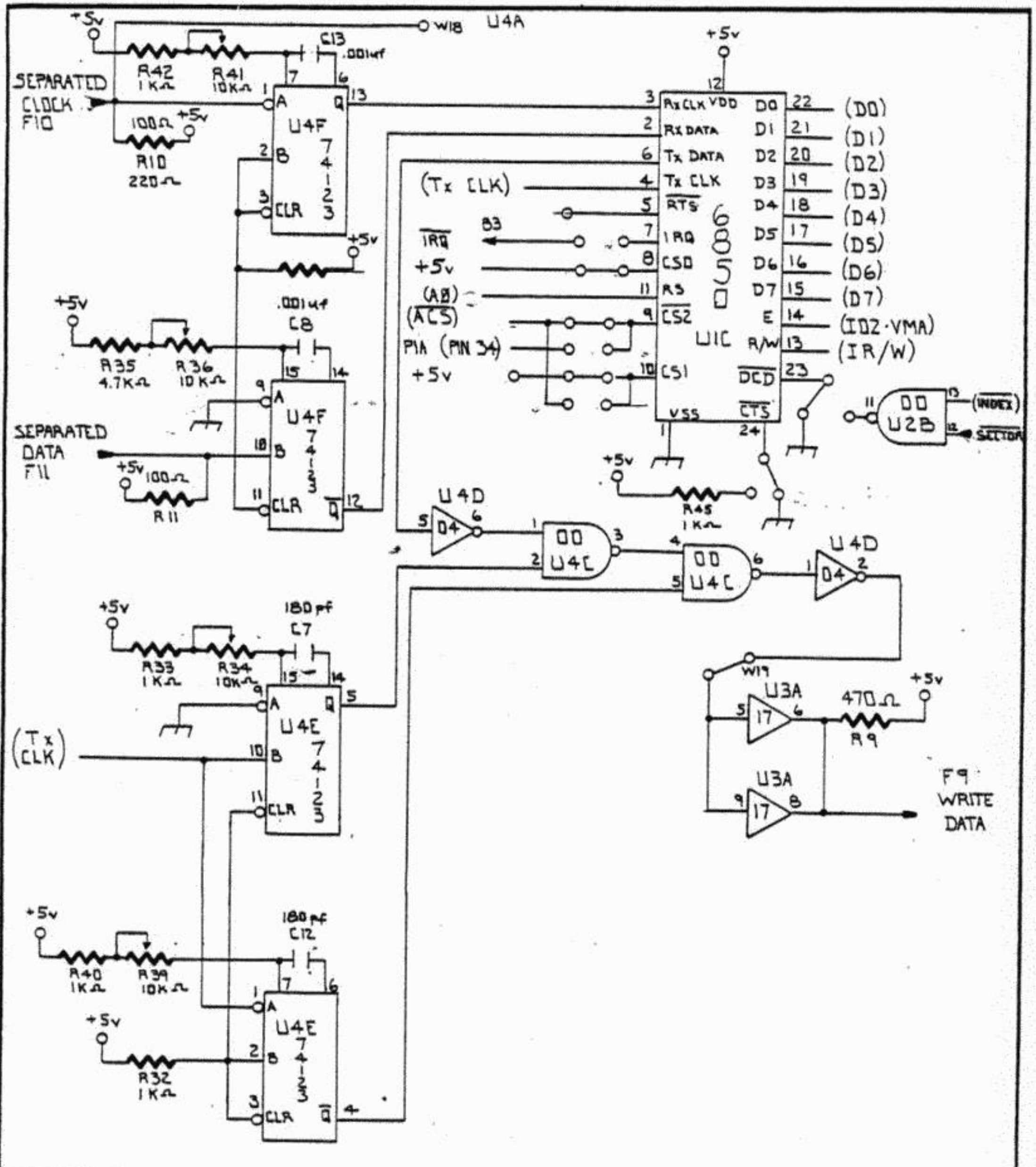

OHIO SCIENTIFIC			product name/number	
			MODEL 470	
date 27 JUL 1979			SINGLE SIDED FLOPPY INTERFACE	
revision	page	status	sheet 5 of 5	
DRAWN ~ J.L.K.				

① SINGLE SIDED FLOPPY INTERFACE ASSEMBLY DRAWING D1

D51 470 REV B

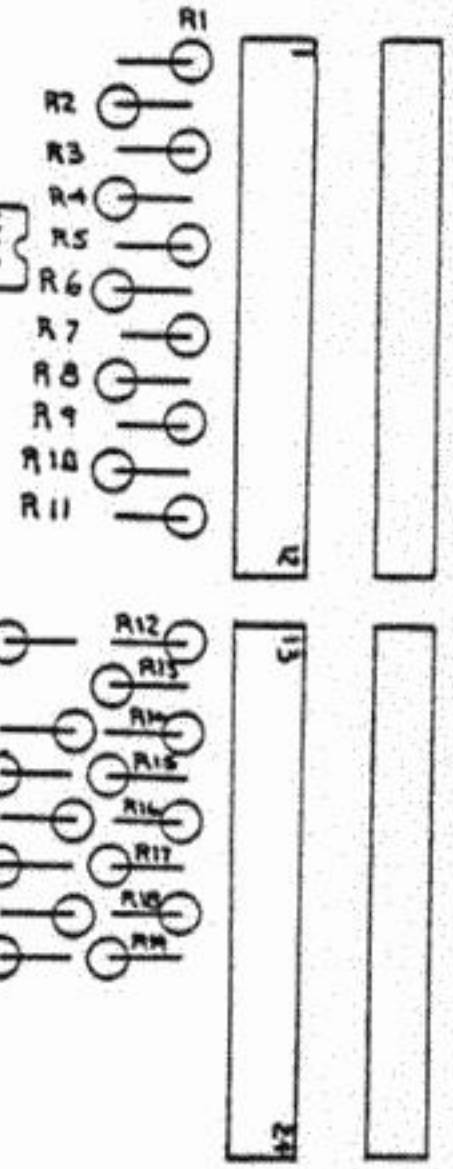

②

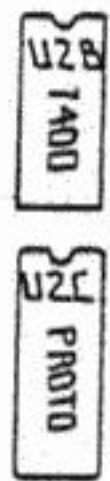
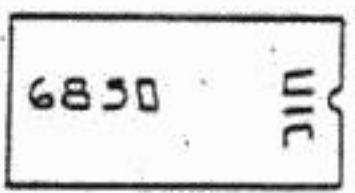
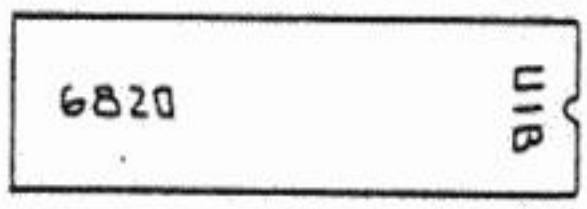

③

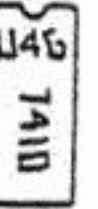
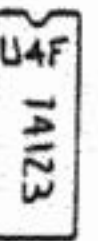
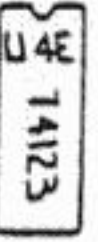
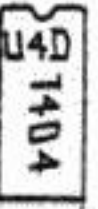
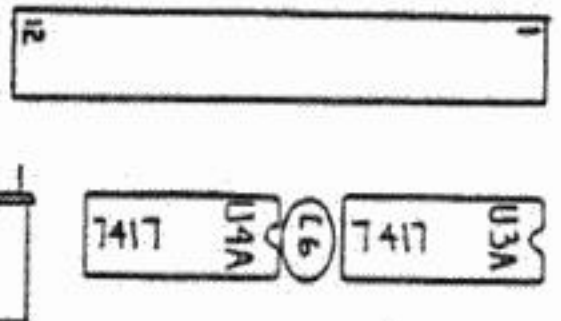
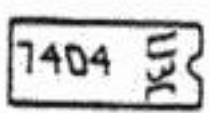

④

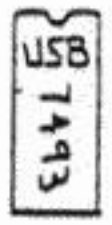
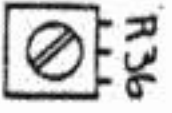
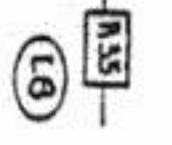
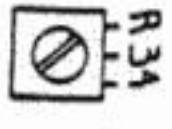
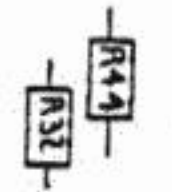
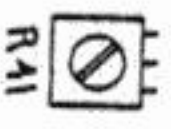

⑤

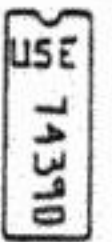
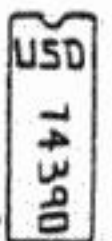
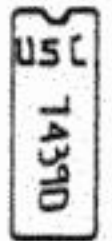

⑥

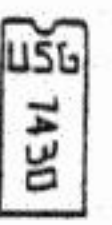
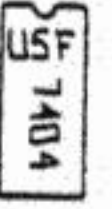

⑦

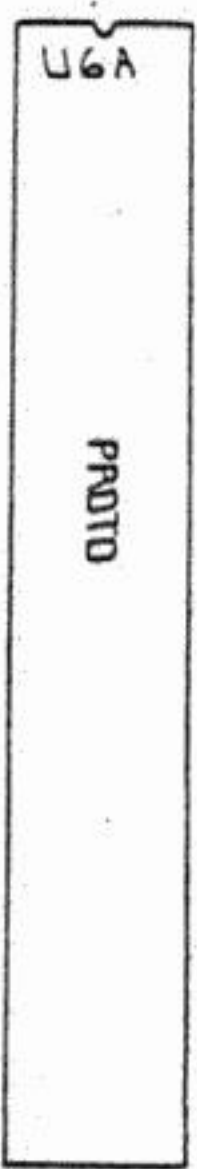

PROTO

