

# 630 MTG Terminal User's Guide

Document Number 999-300-3751S  
Comcode 501006050  
Issue 2, July 1987

Copyright © 1987 AT&T  
All Rights Reserved

## **To Order Copies of This Guide**

Contact: Your AT&T Information Systems Account Team

Or

Call: AT&T Technologies, Inc. on 1-800-432-6600

Or

Write: AT&T Customer Information Center  
P.O. Box 19901  
Indianapolis, Indiana 46219

Order: Document No. 999-300-375IS  
Comcode 501006050

### **FCC WARNING STATEMENT**

This equipment generates, uses and can radiate radio frequency energy and if not installed and used in accordance with the instruction manual, may cause interference to radio communications. It has been tested and found to comply with the limits for a class A computing device pursuant to Subpart J of Part 15 of the FCC Rules, which are designed to provide reasonable protection against such interference when operated in a commercial environment. Operation of this equipment in a residential area is likely to cause interference in which case the user at his own expense will be required to take whatever measures may be required to correct the interference.

AT&T Information Systems reserves the right to revise this document for any reason, including, but not limited to, conformity with standards promulgated by ANSI, EIA, or similiar agencies, utilization of new advances in the state of the technical arts, or to reflect changes in the design of equipment. Liability for difficulties arising from unknown or unforeseen technical limitations is disclaimed.

## IMPORTANT SERVICE INFORMATION

Dear Customer:

The following information is provided to allow us to better meet your service needs. This information should be retained and the directions followed as indicated.

In Case of Trouble

Refer to Chapter 10 titled Maintenance and Troubleshooting and follow the instructions.

If you have a problem with your 630 terminal, contact either of the following AT&T Information Systems Service Organizations.

For terminals connected to an AT&T processor, contact the National Software Support Center (NSSC) on:

**1-800-922-0354**

For terminals connected to a non-AT&T processor, contact the Customer Service Support Organization (CSSO) on:

**1-800-242-2121**



---

# Contents

---

## Overview

About This Manual	1-1
Introducing the 630	1-2
Dependencies	1-5
Hosts	1-5
UNIX Releases	1-5
Software	1-6
Hardware	1-7
Documentation	1-10

---

## Installation

Packaging	2-1
Keyboard	2-1
Mouse	2-3
Controller Base	2-4
Display	2-5
Attaching the Base to the Display	2-6
Connections	2-8
AC Power Cord	2-8
Keyboard Cable	2-9
Mouse Cable	2-9
Interface Cables	2-9
Adjustments	2-10
Brightness	2-10
Contrast	2-11

Tilt 2-11  
Swivel 2-12  
Power On 2-13  
Configuration 2-13  
Verifying Operability 2-13  
Keytop Replacement 2-14

---

## **Mouse and Menu Operation**

Introduction 3-1  
Using the Mouse 3-2  
Button Definitions 3-3  
Mouse Menus 3-4

---

## **Windowing Operations**

Introduction 4-1  
What is a Window? 4-2  
Layers Window Manager 4-4  
Layers Automatic Screen Configuration 4-7  
Main Terminal Menu 4-10  
Mouse Cursor 4-11  
Window Commands 4-13  
New 4-13  
Reshape 4-15  
Move 4-17  
Top 4-19  
Bottom 4-19  
Current 4-19  
Delete 4-21  
Exit 4-21  
Local Windows 4-23

---

## **Windowproc**

630 Native Terminal Emulator 5-1  
Appearance 5-2  
Text Area 5-3

Label Area	5-3
Scroll Area	5-5
Windowproc Setup Options	5-7
Windows	5-7
Buffer Enable	5-7
Window Size	5-8
Font Size	5-8
Fixed Non-Layers Window	5-8
Mouse Operations in Windowproc	5-9
Button 1	5-9
Button 2	5-12
Button 3	5-12
Windowproc Operations	5-13
Edit	5-13
Font	5-18
Buffer	5-20
Peel	5-20
Print	5-22
Programming in Windowproc	5-23
Programming the Label Area	5-23
Programming the Menu	5-24

---

## **Printing**

Introduction	6-1
Printing Using Windowproc Menus	6-2
Printing Using Escape Sequences	6-4
Supported Printers	6-6
5310/5320 Teleprinters	6-6
AT&T 475 and AT&T 476	6-8
Printer Cables	6-11

---

## **Terminal Setup**

Introduction	7-1
Entering Setup	7-2
Viewing and Modifying Options	7-6
Default Settings	7-14

Exiting Setup	7-16
Notes on Use of Setup	7-17
Power On Configuration	7-18
Sample Configuration 1 --- Changing Baud	7-20
Sample Configuration 2 --- Multiple Hosts	7-21

---

## **PF Keys**

Introduction	8-1
Entering PF Edit	8-2
Using PF Edit	8-4
Exiting PF Edit	8-5
An Example	8-6

---

## **Software Support**

Host Software Installation	9-1
630 MTG Software Development Package	9-1
AT&T Windowing Utilities	9-1
User .profile	9-3
TERM variable	9-3
DMD and PATH variables	9-3
630 Termino	9-5
Local Termino	9-8
Changing the Default Fixed Non-Layers Window	9-9

---

## **Maintenance and Troubleshooting**

Care of the Terminal	10-1
Testing Operability	10-2
Automatic Selftest	10-2
User-Initiated Selftest	10-2
Testing the Mouse	10-3
Testing the Keyboard	10-3
Problems/Suggestions	10-4



---

## **Options and Accessories**

Expansion Cards and Accessories 11-1

---

## **Appendix A: Control Characters and Escape Sequences**

Control Characters A-1

Escape Sequences A-3

Attributes A-3

Clear A-3

Cursor A-3

Delete A-4

Download A-4

Font A-5

Insert A-5

Printer A-6

Program A-7

Request A-8

Reset A-8

Reshape A-9

Restore A-9

Save A-9

Scroll A-9

## **Appendix B: 98-Key Keyboard**

### **Glossary**

### **Index**



---

## List of Figures

Figure 1-1	630 MTG Terminal	1-2
Figure 2-1	98-Key Keyboard (With Modification Kit Installed)	2-1
Figure 2-2	630 Mouse	2-3
Figure 2-3	630 Controller Base	2-4
Figure 2-4	630 Display with Styrofoam Packing	2-5
Figure 2-5	Aligning the Base and the Display	2-6
Figure 2-6	Attaching the Base to the Display	2-7
Figure 2-7	630 MTG (Rear View)	2-8
Figure 2-8	630 MTG (Front View)	2-10
Figure 2-9	630 Tilt Range	2-11
Figure 2-10	630 Swivel Range	2-12
Figure 2-11	Keytop Replacement	2-14
Figure 3-1	Button Numbering (Right Hand Mouse)	3-3
Figure 3-2	More Submenu	3-5
Figure 3-3	Scrolling Menus	3-6
Figure 4-1	Window	4-3
Figure 4-2	Layers Window Manager	4-4
Figure 4-3	Layers Icon	4-6
Figure 4-4	Example of Layers Automatic Screen Configuration	4-8
Figure 4-5	630 Main Terminal Menu	4-10
Figure 4-6	Mouse Cursors	4-11
Figure 4-7	Message Boxes	4-12
Figure 4-8	Creating a New Window	4-14
Figure 4-9	Reshaping a Window	4-16
Figure 4-10	Moving a Window	4-18
Figure 4-11	Current Window	4-20
Figure 4-12	Local Windowproc Window	4-23
Figure 5-1	Windowproc Window	5-2
Figure 5-2	Label Area	5-4
Figure 5-3	Scroll Area	5-5
Figure 5-4	Windowproc Menu	5-12
Figure 5-5	Edit Submenu	5-14

Figure 5–6	Sweeping a Command Line	5–17
Figure 5–7	Selecting Send	5–18
Figure 5–8	Font Submenu	5–19
Figure 5–9	Buffer Submenu	5–20
Figure 5–10	Peeling a Window	5–21
Figure 6–1	Windowproc Print Submenu	6–2
Figure 7–1	Selecting Setup	7–3
Figure 7–2	Setup Window	7–4
Figure 7–3	First Level Setup Menu	7–5
Figure 7–4	Default Power On Window	7–18
Figure 7–5	Port Selections with Optional Host Card	7–22
Figure 8–1	Selecting PF Edit	8–2
Figure 8–2	PF Edit Window	8–3
Figure B–1	Key Position Numbers	B–1

---

## LIST OF TABLES

Table 1-1	630 Ordering Codes	1-7
Table 1-2	Main1, Main2 EIA Port	1-8
Table 1-3	Auxiliary EIA Port	1-9
Table 5-1	Button 1 Windowproc Operations	5-9
Table 6-1	Windowproc Print Summary	6-3
Table 6-2	5310/5320 Options	6-7
Table 6-3	475/476 Options	6-9
Table 7-1	Setup Options	7-14
Table 11-1	Expansion Cards and Accessories	11-1
Table A-1	CONTROL CHARACTERS	A-1
Table B-1	Key Codes	B-2

---

## About This Manual

The 630 MTG Terminal User's Guide describes how to install, operate, and care for your terminal. Appendix A and B contain information on ASCII control characters, escape characters, and the transmitted character codes the keyboard sends.

This guide also contains a glossary of terms and definitions associated with terminal operation.

You will find it helpful to read the manual, particularly Chapters 1 through 3, before attempting to operate your 630. Refer to it while you configure your terminal and when you encounter specific questions. Once you understand the basic operation of the 630, you will want to read the manual thoroughly to familiarize yourself with the terminal's more advanced features.

The Sequence followed is -

- Chapter 2: Installation
- Chapter 3: Mouse and Menu Operation
- Chapter 4: Window Operation
- Chapter 5: Windowproc
- Chapter 6: Printing
- Chapter 7: Terminal Setup
- Chapter 8: PF Keys
- Chapter 9: Software Support
- Chapter 10: Maintenance and Troubleshooting
- Chapter 11: Options and Accessories

Appendix A: CONTROL CHARACTERS and ESCAPE SEQUENCES

Appendix B: 98-KEY KEYBOARD

Glossary

---

## Introducing the 630

The 630 MTG is a high resolution, multi-window, multi-host, programmable graphics terminal. Its intelligence makes it ideal in application environments as diverse as software development, text preparation, engineering, and operations support systems.

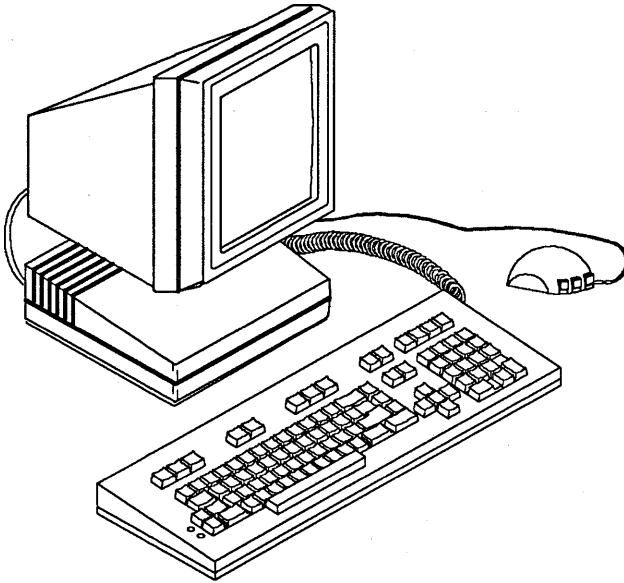

**Figure 1-1** 630 MTG Terminal

---

One of the primary features of the 630 is its support of two terminal environments: *layers* and *non-layers*. In the 630's native *non-layers* environment, no special host support is required for terminal operation.

On a host running the UNIX® System V, the terminal's behavior is driven by its *terminfo*\* description. In addition, software is available to allow downloading of self-contained terminal application programs. In the *layers* environment, a window manager† supports up to seven terminal sessions over a single host connection and an error-correcting protocol provides full support of downloadable applications.

A second feature of the terminal is the ability to support multiple, concurrent host connections. The 630 supports up to two host connections at any given time, either or both of which may be in the *layers* environment.

Programmability is a third feature. Users may create custom applications using the 630 MTG Software Development Package.

Other features include:

- Mouse-based user interface with menus for selection of terminal operations.
- Text buffering and scrolling.
- Selectable font.
- Multiple resident fonts.
- Local text printing capability.
- 1024 x 1024 pixel display on a 16" CRT.
- 60/50 Hz selectable, non-interlaced display.
- A non-glare screen.
- Display tilt and swivel.

---

\* See *terminfo(4)* in the UNIX System V Programmer Reference Manual for further information on *terminfo*. The *terminfo* description for the 630 is given in Chapter 9.

† See Chapter 4 for a discussion of windowing and the *Layers* window manager.



- Front access to power, contrast, and brightness controls.
- Detached, low-profile keyboard.
- Three-button mouse.
- Two RS 232-C ports for connection to external devices.
- Optional third RS 232-C port.
- 10 MHz 68000 processor.
- Domestic and international power level compatibility.
- Up to 384 Kbytes Read Only Memory (terminal control software).
- 640 Kbytes Random Access Memory standard.
- 8 Kbytes non-volatile RAM for options storage.
- Up to 384 Kbytes ROM in optional external cartridges for providing additional terminal capability.
- RAM and I/O expansion capability via internal expansion connectors (See Chapter 11).

---

## Dependencies

### Hosts

The 630 can be used in the *non-layers* environment on any asynchronous host computer or in the *layers* environment on any host that supports the AT&T Windowing Utilities package. It is certified for use in the *layers* environment on the AT&T 3B family of computers.

### UNIX Releases

Although the 630 may be used without the aid of special software, it is most powerful when used with the AT&T Windowing Utilities package. The *Layers* window manager, which is part of this package, is described in Chapter 4.

The AT&T Windowing Utilities package is a standard utilities package delivered with UNIX System V Release 3 (System V Release 2.1.1 for the 3B20) and beyond. For UNIX systems not containing the AT&T Windowing Utilities package, similar functionality can be obtained by installing the 5620 DMD Core package, as described in Chapter 9.

## Software

Software available for use with the 630:

- 630 MTG Software Development Package

This package enables users to develop and execute downloadable terminal applications. It contains the 68000 C Compilation System, the application downloader, terminal-specific library functions, development tools, and sample application programs.

- 5620 DMD Core Package

This package provides windowing support for use with UNIX system releases prior to those containing the AT&T Windowing Utilities package.

---

## Hardware

The ordering codes for the standard 630 features are listed in Table 1-1. Optional cards and accessories are listed in Chapter 11.

**Table 1-1** 630 Ordering Codes

---

Item	Comcode	PE Code
Display	501001697	33534 Col19
Base & Controller	501001671	3344-630
98-Key Keyboard	501004865	33401
Mouse	524594157	33536

Interface cables needed for operation with the 630 are described in Table 1-2 and Table 1-3. Note that Main2 is the EIA port that is on the optional SSI/EIA Interface Card (See Chapter 11 for ordering codes). For additional information, refer to the 630 MTG Service Manual (See Chapter 1 for ordering information).

**Table 1–2** Main1, Main2 EIA Port

Main1, Main2 EIA port connected to:				
Device	Description	Length	Comcode	PE Code
DATAKIT, Modem	Male to Male (One to One)	7'	524161742	2724-14G
		12'	524161759	2724-14L
		25'	524161767	2724-14S
		50'	524161775	2724-14V
3B2	25 Pin (Male) to 8 Pin Modular Adapter		403602717	2750-C09
	8 Pin Modular Cord	7'	403600968	2725-16G
		14'	403600976	2725-16N
		25'	403600984	2725-16S
50'	403600992	2725-16V		
3B5, 3B15, 3B20	Male to Female (Null Modem)	6'	524163417	2724-92G

**Table 1-3** Auxiliary EIA Port

Auxiliary EIA port connected to:					
Device	Description	Length	Comcode	PE Code	
DATAKIT, Modem	Male to Male (One to One)	7'	524565959	2724-99G	
		12'	524565967	2724-99L	
		25'	524565975	2724-99S	
		50'	524565983	2724-99V	
3B2	25 Pin (Male) to 8 Pin Modular Adapter (Null Modem)		403434020	2750-C11	
		8 Pin Modular Cord	7'	403600968	2725-16G
			14'	403600976	2725-16N
			25'	403600984	2725-16S
50'	403600992		2725-16V		
3B5, 3B15, 3B20	Male to Female (One to One)	12'	524080660	2724-01L	
		25'	524080678	2724-01S	
		50'	524080686	2724-01V	
5310/5320 Teleprinters	Male to Female (One to One)	12'	524080660	2724-01L	
		25'	524080678	2724-01S	
		50'	524080686	2724-01V	
AT&T 475, 476 Printers	Male to Male (One to One)	7'	524161742	2724-14G	
		12'	524161759	2724-14L	
		25'	524161767	2724-14S	
		50'	524161775	2724-14V	



---

## Documentation

Available documentation for the 630:

- 630 MTG Terminal User's Guide (999-300-375IS)  
Select Code: 981-340  
Comcode: 501006050

This document.

- 630 MTG Service Manual (582-630-030IS)  
Select Code: none  
Comcode: 501004204

This manual contains installation, setup, diagnostics, disassembly, adjustment, and cable information.

- 630 MTG Software Development Package Release Notes (999-300-342IS)  
Select Code: 930-342  
Comcode: 501003560

These notes describe the contents of the 630 MTG Software Development Package.

- 630 MTG Software Development Guide (999-300-341IS)  
Select Code: 930-341  
Comcode: 501003552

This guide describes how to develop downloadable terminal applications using the 630 MTG Software Development Package.



- 630 MTG Software Reference Manual (999-300-340IS)  
Select Code: 930-340  
Comcode: 501003545

This manual contains more detailed information for use in developing applications.

Available documentation that pertains to the 630 MTG but was written for the 5620 DMD.

- 5620 Dot-Mapped Display Administrator Guide (999-801-120IS)  
Select Code: 306-141  
Comcode: None

This guide describes how to use the 5620 DMD core package for use with *Unix Operating System* releases not containing the AT&T Windows Utilities package.

For pricing information on available 630 documents, contact the Customer Information Center Commercial Sales Representatives at this number:

1-800-432-6600 (toll free)

# Chapter 2: Installation

---

## Contents

---

### Packaging 2-1

Keyboard 2-1

Mouse 2-3

Controller Base 2-4

Display 2-5

---

### Attaching the Base to the Display 2-6

---

### Connections 2-8

AC Power Cord 2-8

Keyboard Cable 2-9

Mouse Cable 2-9

Interface Cables 2-9

---

### Adjustments 2-10

Brightness 2-10

Contrast 2-11

Tilt 2-11

Swivel 2-12

---

**Power On** 2-13  
**Configuration** 2-13  
**Verifying Operability** 2-13

---

**Keypad Replacement** 2-14

---

## Packaging

The components of the 630 terminal are packed in five separate cartons: one each for the keyboard, mouse, controller base, display, and 630 MTG Terminal User's Guide (this manual).

## Keyboard

The keyboard is shipped fully assembled. Simply remove it from the carton.

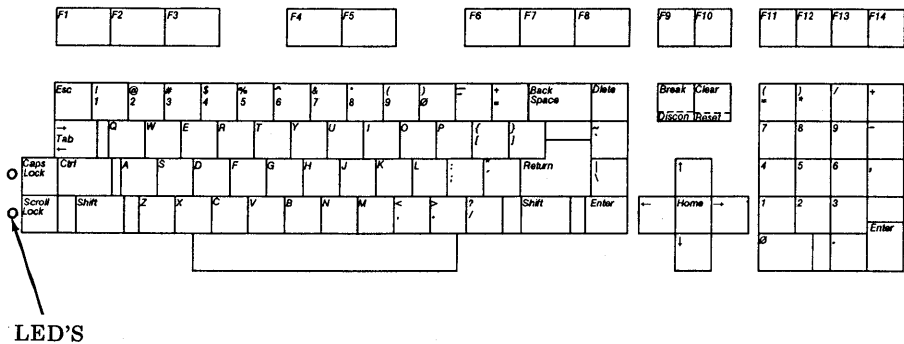

**Figure 2-1** 98-Key Keyboard (PE Code 33538 Modification Kit Installed)

---

The 98-key keyboard provides the usual set of "qwerty" keys, along with a number of keys for special operations:

- 8 user programmable function (PF) keys. Chapter 8 describes how to program these keys.
- 6 non-programmable function keys. These keys can be used by application programs which require keys to be reserved for special operations.

- A numeric keypad for easy entry of numeric sequences. Besides digits, it contains numerical operators, comma, parentheses, and an ENTER key.
- *Enter* keys in the main keyboard area and on the numeric pad. The sequence sent by *Enter* is programmable (see Appendix A) and defaults to a carriage return.
- Text cursor control keys, which include a right arrow, a left arrow, an up arrow, a down arrow, and a "Home" key.
- *Caps Lock* key with associated LED. When on for a window, Caps Lock causes the Shifted values of all alphabetic keys to be sent when pressed. It does not affect numeric, PF, or other keys. Caps Lock is handled on a per-window basis.
- *Scroll Lock* key with associated LED. Scroll Lock is handled on a per-window basis. The action taken when Scroll Lock is on in a window depends on the application running in the window. In Windowproc (the native 630 terminal emulator), pressing Scroll Lock causes host communication for the current window to be blocked until Scroll Lock is pressed again in that window.
- *Break/Discon* The *Break* key causes a timed signal of 400 milliseconds to be sent for a non-layers host process. Data on the incoming line may be lost to the terminal. This key has no effect on a layers terminal process.

In a non-layers host process, holding down the *Ctrl* key and depressing *Discon* turns off the DTR signal for approximately 2 seconds. This key has no effect on a layers terminal process.

- *Clear/Reset* The *Clear* key sends an ESC[2J. The screen reply to a received ESC[2J is a clear entire screen and screen buffer.

For *Reset*, the *Ctrl* and *Clear* are held down to send an ESC c. A received ESC c causes a terminal reset which will clear the screen and the buffer.

Whether or not the keys produce an audible "click" is a Terminal Setup option. Most keys repeat. The repeat rate and volume for the bell and keyclick are also controlled through Setup (See Chapter 7).

PF keys depressed with Shift or Control transmit the same codes as they do when unshifted. The transmitted codes for all keys are given in Appendix B.

## Mouse

The mouse is shipped fully assembled. Simply remove it from the carton.

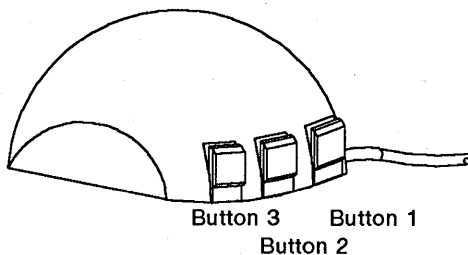
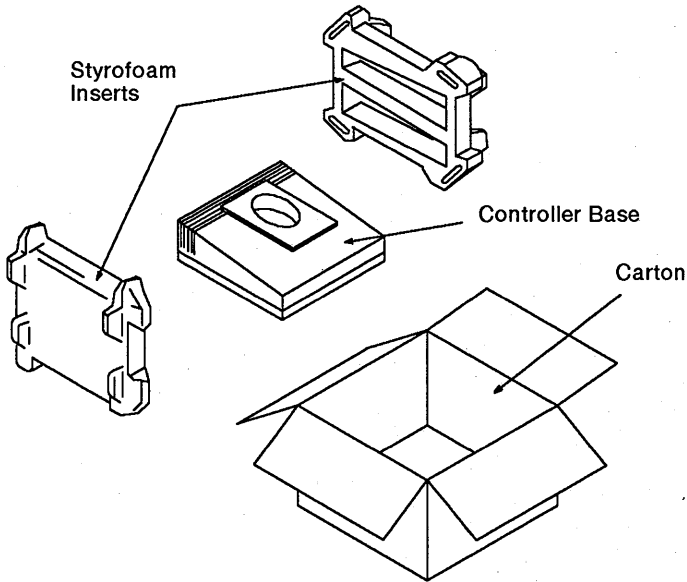

Figure 2-2 630 Mouse

---

## Controller Base

To unpack the controller base, lift it from the carton by the foam pack end pieces. Then remove the end pieces and plastic bag protecting the base (See Figure 2-3).

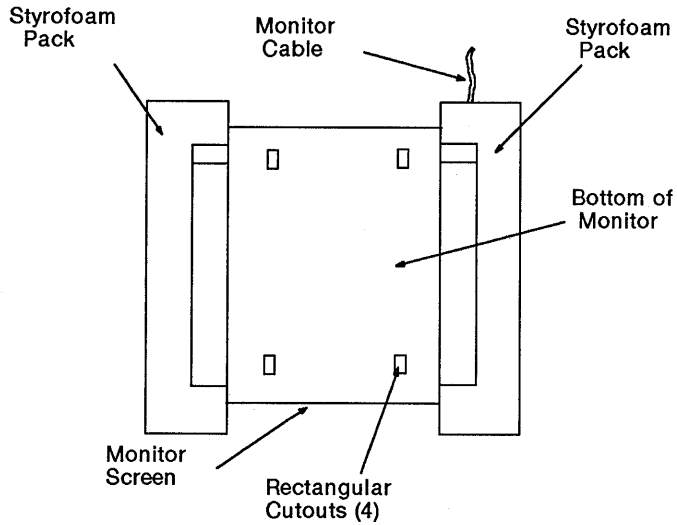

**Figure 2-3** 630 Controller Base

---

## Display

To unpack the display, slide the foam inner pack out of the box. Lift the display with the foam pack intact, placing it next to the controller base. Orient the display with the screen downward and the bottom facing you (See Figure 2-4).



**Figure 2-4** 630 Display with Styrofoam Packing

---



---

## Attaching the Base to the Display

- 1 Spread the opening of the plastic bag (not shown) covering the display so that the four rectangular cutouts in the bottom of the display are clear.
- 2 Pick up the controller base and align the tabs on the swivel with the lower cutouts on the bottom of the display as shown in Figure 2-5.

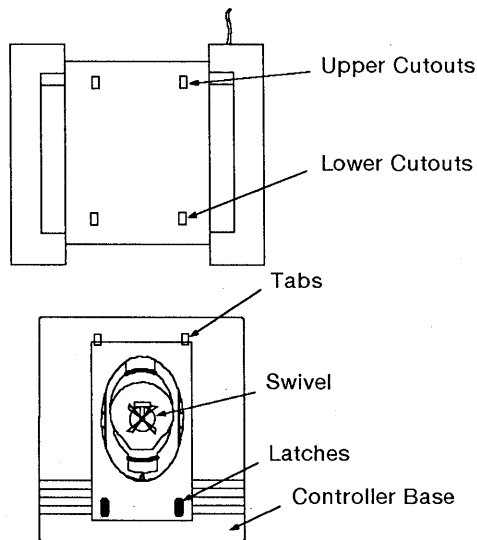

**Figure 2-5** Aligning the Base and the Display

---

- 3 Insert the tabs into the cutouts and pivot the controller base upward so that the latches on the swivel engage the upper cutouts on the display. This secures the controller base to the display.

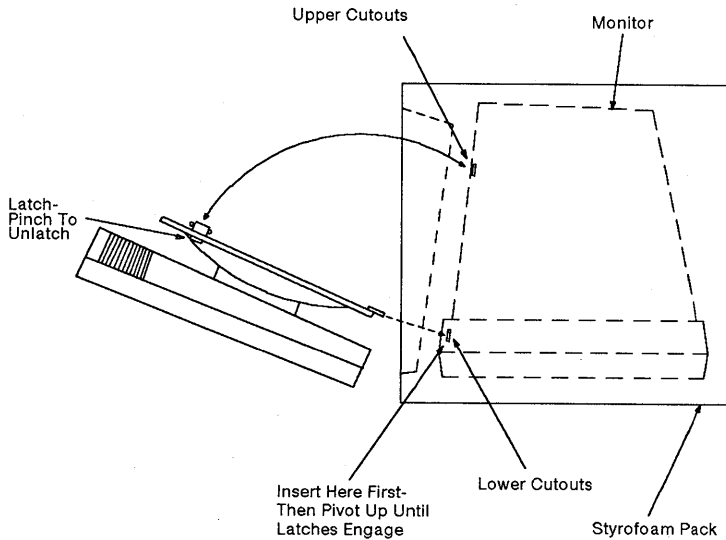

**Figure 2-6** Attaching the Base to the Display

- 4 Tip the controller base and the display to an upright position and remove the foam pack and plastic bag.
- 5 Connect the free end of the display I/O cable to the connector marked "VIDEO" in the rear of the controller base. Secure the cable to the controller base by tightening the two captive screws on the connector (See Figure 2-7).

---

## Connections

All cables attach to the rear of the terminal.

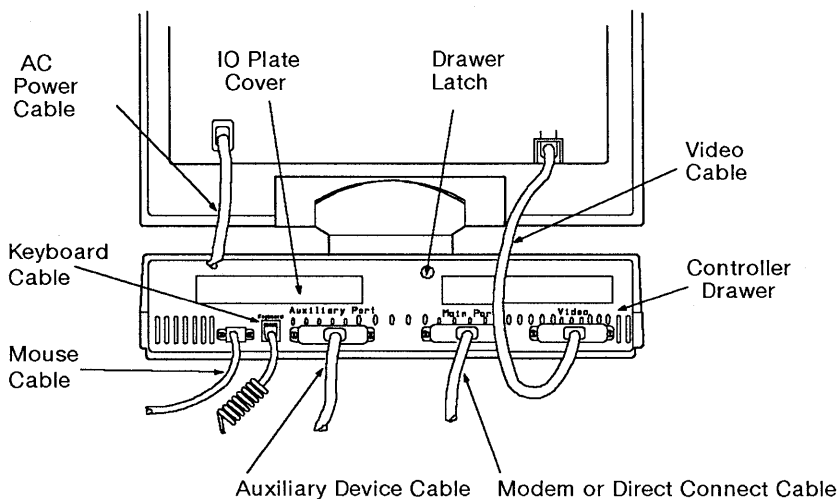

**Figure 2-7** 630 MTG (Rear View)

---

### AC Power Cord

- 1 Remove the AC cord from the tissue wrapped package in the bottom of the display carton.
- 2 Connect the female end of the power cord to the AC connector on the back panel of the display.

- 3 Check that the AC power switch, located on the lower edge of the front of the display, is off (left side of the switch flush with the display). Insert the male end of the power cord into a 110 VAC outlet.

### **Keyboard Cable**

The keyboard cable is equipped with a quick release modular jack connector. Insert the connector into its receptacle on the rear of the controller base by pushing the connector straight in with the latch side down.

### **Mouse Cable**

Attach the mouse cable by lining up the pins on the connector with the mouse receptacle on the rear of the controller base. After connecting the cable, secure it by tightening the two retaining screws on the connector.

### **Interface Cables**

Attach the cables\* to be connected to the MAIN and AUX ports by lining up the pins on the connectors with the corresponding receptacles on the rear of the controller base. After connecting the cables, secure them by tightening the two retaining screws on each connector.

---

\* Interface cables do not accompany the terminal and must be ordered separately. See Chapter 1.

---

## Adjustments

The brightness and contrast controls are located on the lower edge of the front of the display.

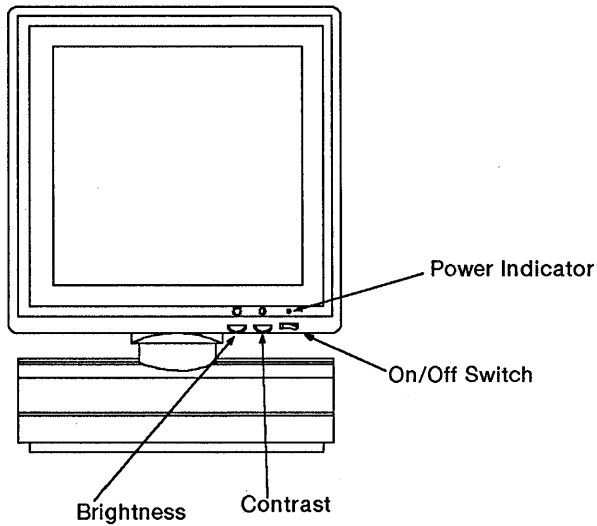

**Figure 2–8** 630 MTG (Front View)

---

### Brightness

Turn the brightness control wheel to the left to increase the screen brightness. Turn it to the right to decrease the brightness.

## Contrast

Turn the contrast control wheel to the right to increase the screen contrast (brightness of the characters relative to the brightness of the background). Turn it to the left to decrease the contrast.

## Tilt

Tilt the display forward or backward manually to a comfortable viewing position. The range of motion is -5 to +20 degrees from true horizontal.

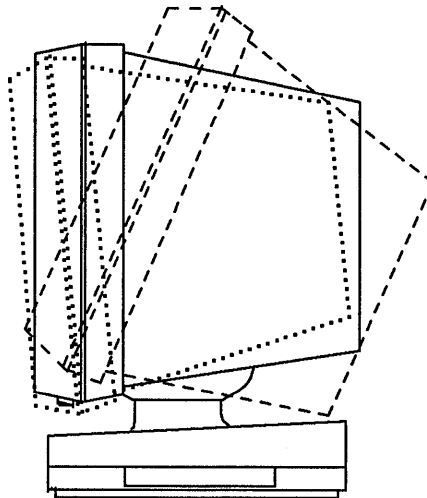
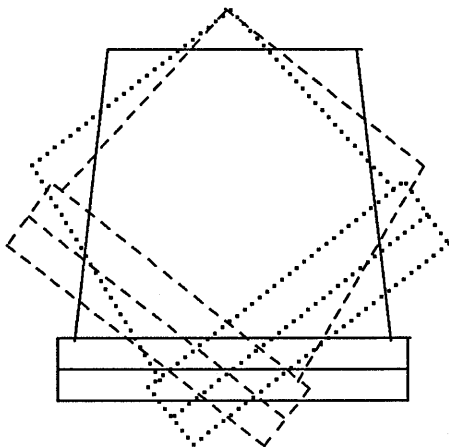

**Figure 2-9** 630 Tilt Range

---

## Swivel

Swivel the display left or right manually to the desired position. The range of motion is 45 degrees in either direction.



**Figure 2–10** 630 Swivel Range

---

---

## Power On

### Configuration

The appearance of the screen after the terminal is powered on depends on user-selected Terminal Setup options (See Chapter 7).

### Verifying Operability

A test of basic terminal operability is performed automatically when the terminal is powered on. See Chapter 10 for more information on this test.

**Note:** *The 630 has a built-in sleep feature to help extend the life of the display. When neither the keyboard nor the mouse has been used for 15 minutes, the screen will blank until a key or mouse button is pressed or the mouse is moved. Programs running at the time the screen blanks will not be affected by this feature.*



---

## Keytop Replacement

The red legends on the "f" keys (*Set-Up, Mode, Print, User Fkey, I/O Fkey, and Sys Fkey*) are not utilized by the 630 terminal. If the red legends are objectionable, order the 98-key keyboard modification kit which contains replacement keys along with a tool for replacing the keytops. (See Chapter 11 for the ordering codes.)

Remove the keytop by hooking the tool under the keytop and pulling upward. Push the replacement keytop into place.

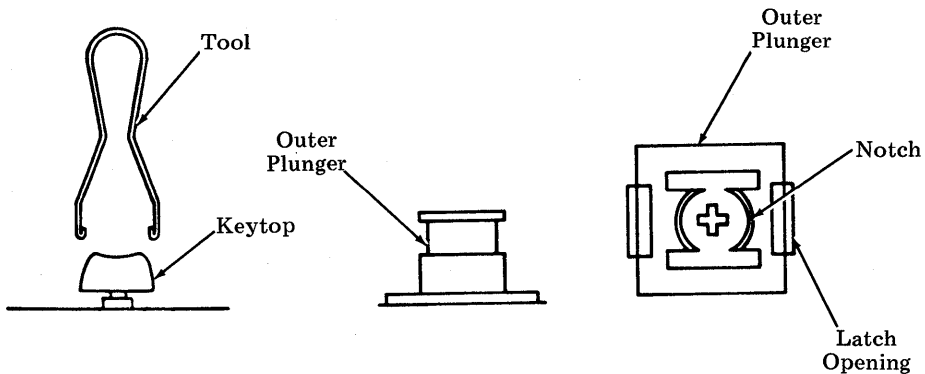

**Figure 2-11** Keytop Replacement

---

**Note:** The outer plunger may pull out of the keyswitch when removing the keytop. Should this happen, a replacement plunger is provided in the kit. Check that the compression spring is still in the keyswitch; then insert the plunger into the keyswitch and push down on the plunger until it engages.

# **Chapter 3: Mouse and Menu Operation**

---

## **Contents**

---

**Introduction** . 3-1

---

**Using the Mouse** 3-2

---

**Button Definitions** 3-3

---

**Mouse Menus** 3-4

---

## **Introduction**

The mouse is the primary means of selecting terminal operations. It is also used as a pointing device to aid in window manipulation and scrolling.

---

## Using the Mouse

To operate the mouse, place the palm of your hand over the top of the mouse, with your index, middle, and ring fingers resting on the three buttons. Do not press any buttons for now. Slide the mouse back and forth on the work surface and notice the movement of the arrow (called the **mouse cursor**) on the screen. Note that the mouse can be lifted and repositioned on the work surface without moving the mouse cursor.

The buttons cause various operations to be performed, depending on the location of the mouse cursor relative to the terminal windows and on what application program is running in each window. Specific operations will be explained in Chapter 4 (Windowing Operations), Chapter 5 (Windowproc), Chapter 6 (Printing), Chapter 7 (Terminal Setup), and Chapter 8 (PF Keys).

---

## Button Definitions

The buttons on the mouse are numbered 1-3, with "Button 1" always being associated with the index finger of either the right or left hand. The right or left hand mouse option is specified in the Terminal Setup Options (see Chapter 7).

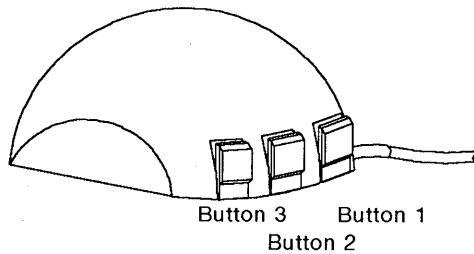

**Figure 3-1** Button Numbering (Right Hand Mouse)

---

Depressing and releasing a mouse button are two distinct actions. To **depress** a button means to press it down and hold it; to **release** it means to let go. To **click** is to depress and release a button (usually in quick succession) with no intervening mouse movement. **Sweeping** involves pressing a designated button, moving the mouse to "sweep out" a desired area, and then releasing the button.

---

## Mouse Menus

Menus like the **main terminal menu** (See Chapter 4) are called **pop-up menus**; they appear only while a particular mouse button is being depressed. Selection of an item in a pop-up menu is made by positioning the mouse cursor over the desired item and releasing the button (in the case of the main terminal menu, Button 3). Items within the menu are **highlighted** in reverse video as the mouse cursor passes over them. Invalid selections (those which are not allowed under the current conditions) are not highlighted and appear in **half-intensity font**.

Menus such as those used in Terminal Setup (see Chapter 7) are called **static menus** because they remain on the screen after the button is released. Selection in a static menu is made by positioning the mouse cursor over the desired item and clicking the button (in the case of Setup, Button 1). Highlighting of selections works the same as in pop-up menus, and invalid selections are again displayed in half-intensity.

Both pop-up and static menus can have other menus associated with them (**submenus**). For example, the main terminal menu contains an item called "More" which has an arrow beside it. This indicates that "More" has a submenu of selections associated with it. The items in a submenu can be viewed by placing the mouse cursor over the arrow which points to the submenu.

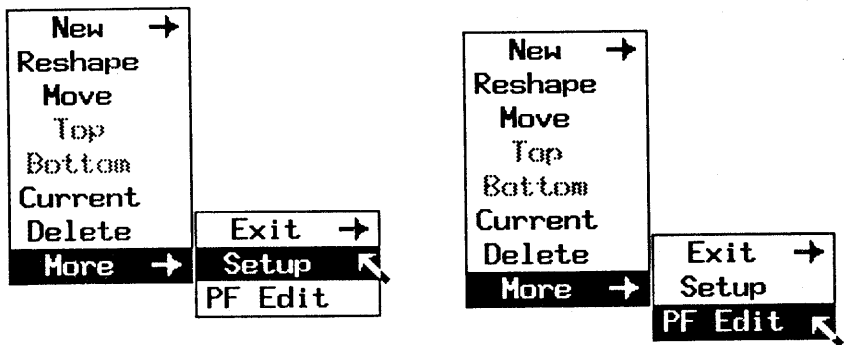
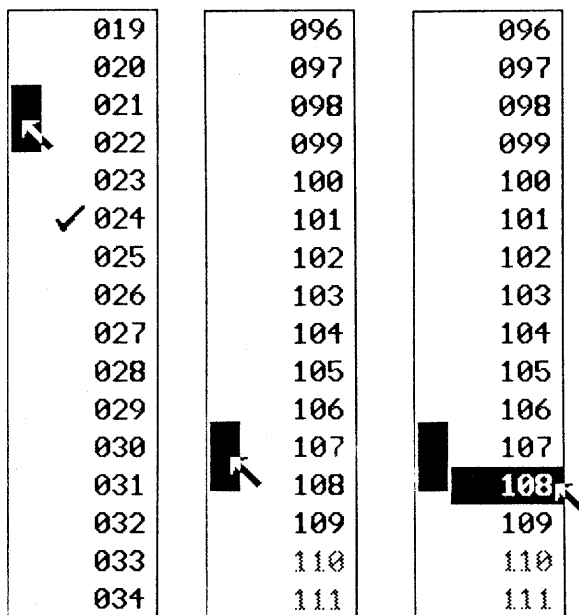

Figure 3-2 More Submenu

Sliding the mouse further to the right enables selections to be made from the submenu. Selections are always made at the rightmost level of the menu (where an item has no further submenus).

A maximum of 16 selections can be displayed at one time in a menu. If a menu contains more than 16 items at any level, a highlighted "scroll" area will appear on the left side of the menu. This indicates that only a portion of the available menu items are currently displayed.



**Figure 3-3** Scrolling Menus

---

Since an item can be selected only when it is currently displayed, it is necessary to scroll through the items until the desired item is within the displayed list. To do this, position the mouse cursor over the menu's scroll area and move it up or down until the item is visible. Then, move the mouse cursor to the right (out of the menu's scroll area) and either up or down to position it over the item to be selected. The selection can then be made in the usual way. Figure 3-3 shows an example of scrolling menus.



# **Chapter 4: Windowing Operations**

---

## **Contents**

---

**Introduction** 4-1

---

**What is a Window?** 4-2

---

**Layers Window Manager** 4-4

---

**Layers Automatic Screen Configuration** 4-7

---

**Main Terminal Menu** 4-10

---

**Mouse Cursor** 4-11

---

**Window Commands** 4-13

New 4-13

Reshape 4-15

Move 4-17

Top 4-19

Bottom 4-19

Current 4-19

Delete 4-21

Exit 4-21

---

**Local Windows** 4-23

---

## **Introduction**

All interaction with the 630 MTG, from keyboard input and screen output to host communications, is performed within the context of a window.

---

## What is a Window?

A **window** is an independently behaved rectangular area of the screen. Several windows can be present on the screen at one time, possibly overlapping one another. It is also possible for the terminal to have no windows on the screen.

The **current** window is the only one which can receive input from the keyboard or mouse. All other windows are **non-current**. The current window is indicated by a highlighted (thicker, brighter) border. It is possible for none of the terminal's windows to be current. Typing on the keyboard when no window is current will cause the bell to ring.

The first window created to the host is the "utemp" (user temporary) window. This window always receives the host status messages. Do not hide this window. Always refer to the "utemp" window if a bell is heard. The host may have sent an important status message.

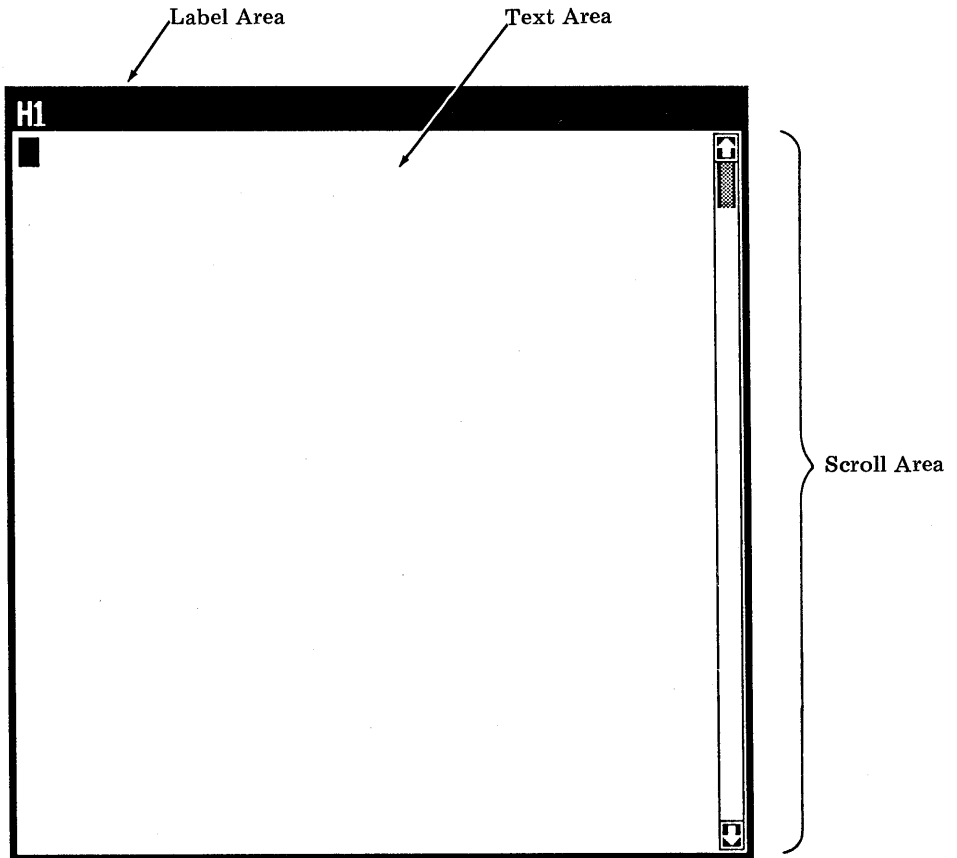

**Figure 4-1** Window

Both current and non-current windows may receive and display data from the hosts they are connected to. In other words, the terminal can support several applications simultaneously.

---

## Layers Window Manager

Multiple windows to the same logical host (over the same physical connection) are possible using the *layers* window manager.

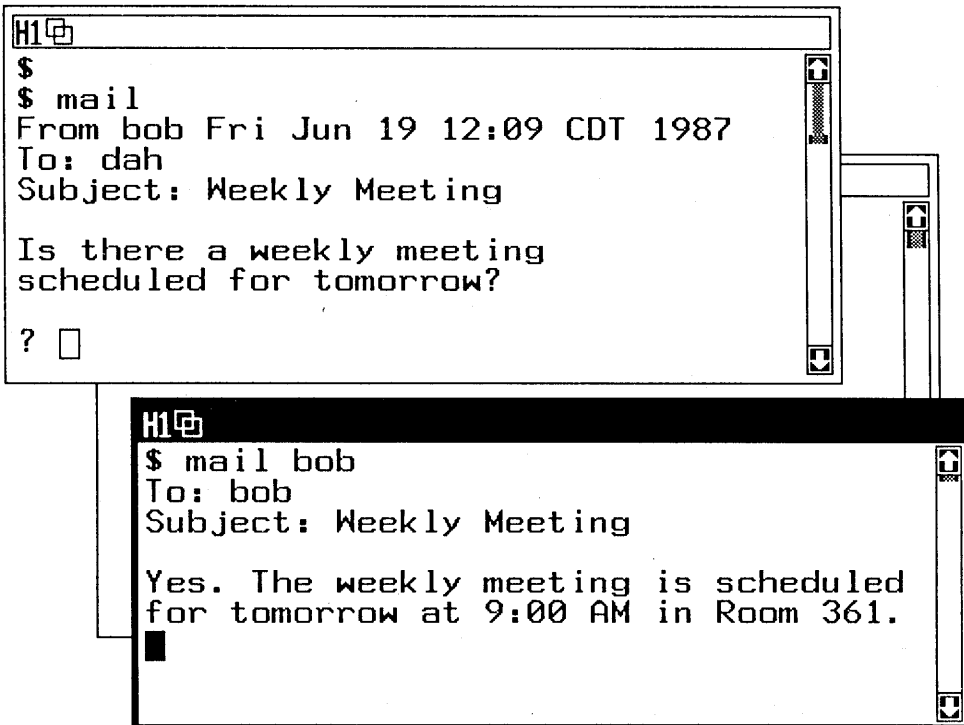

Figure 4-2 Layers Window Manager

---

The *layers* window manager transparently performs housekeeping chores that allow the creation of windows of variable size, reshaping of existing windows, and changing of fonts on a per window basis. These operations are not available in the *non-layers* environment.

Because experienced users may object to such limitations, they may be overridden by selecting "No" for the "Fixed Non-Layers Window" Setup option. However, the user should be aware of potential difficulties discussed under this option in Chapter 7.

Windowproc, the native terminal emulator, is described in Chapter 5.

Once you have made any necessary changes to your terminal environment (See Chapter 9), you can use the *layers* window manager by typing

```
layers
```

in a *non-layers* Windowproc window which is connected to a host on which the necessary software is installed.

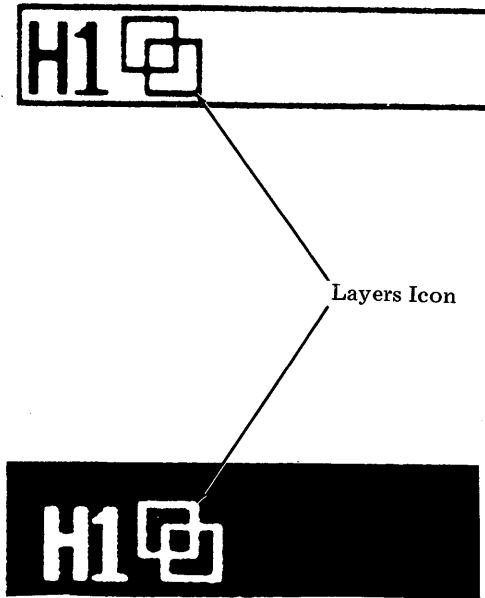

**Figure 4-3** Layers Icon

---

You will see the **layers icon** appear in the window's label area; that window will be the first window in the *layers* session. You can create other windows to the host using the "New" command on Button 3. When you are ready to end the *layers* session, use the "Exit" command on Button 3. Both these commands are described in detail later in this chapter. The terminal supports up to seven windows per *layers* host session. Both hosts may simultaneously run *layers* sessions.



---

## Layers Automatic Screen Configuration

The *-f* option of *layers* allows automatic definition of several windows and automatic execution of programs in those windows based upon a host resident configuration description.

For example, typing

```
layers -f config
```

in the default *non-layers* window where *config* is the file containing:

```
917      6 1018   135   dmddemo clock
   6      6  915   512   exec sh
   58    325  967   825   exec sh
  109    514 1018  1018   echo "This layer is current!"; exec sh
```

causes the screen to be configured as shown in Figure 4-4 on the next page.

**Note:** The 630 MTG Software Development Package is required to execute the above shell program. If you do not have the 630 MTG Software Development Package, delete the first line from *config*.

Typing `layers -f config` will produce Figure 4-4 on the next page without the clock in the upper right hand corner.

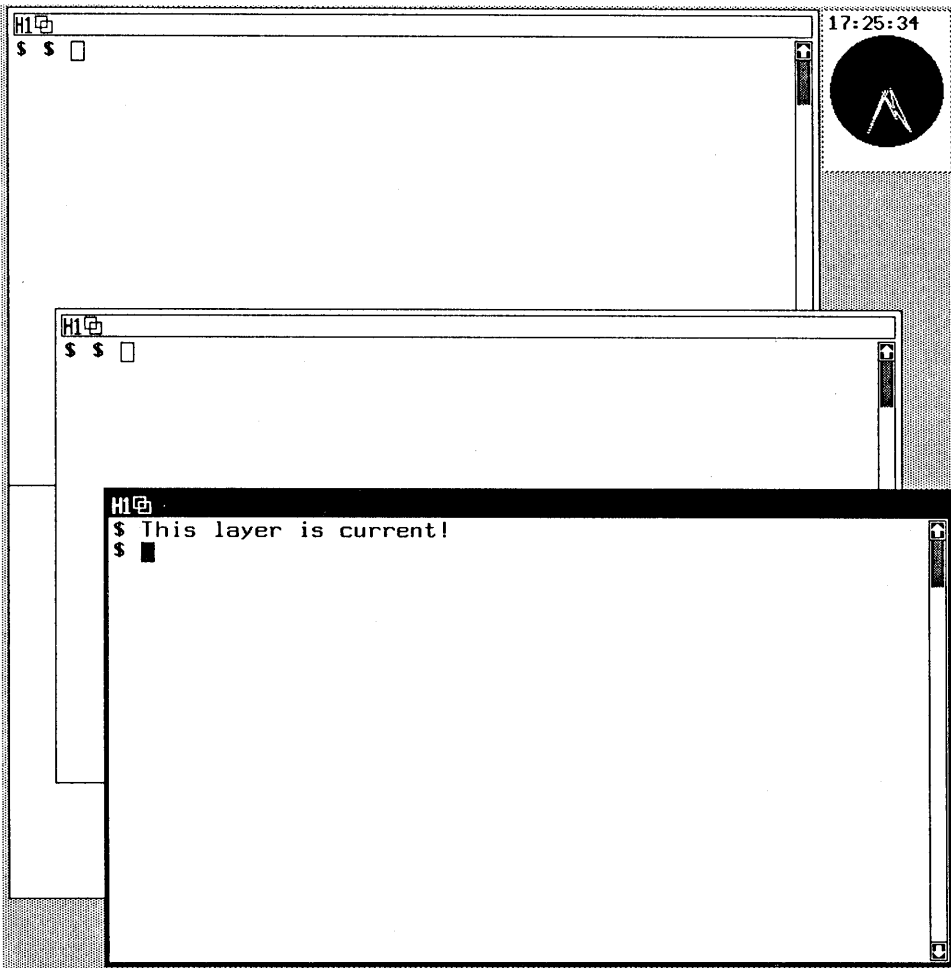

Figure 4-4 Example of Layers Automatic Screen Configuration

Note that the original *non-layers* window is retained and becomes a window in the *layers* session. Any command that can be executed in a window may appear in a configuration file.

Windows to the other logical host are not affected but may be hidden by the new windows created. The last window created is made current.

**Note:** In early versions of the *layers* host software, pressing mouse buttons while windows from a configuration file are being created can interfere with the terminal's operation and should be avoided.

The four numbers on each line of the configuration file are interpreted as two (x,y) coordinate pairs. The first pair on each line represents the pixel coordinates of the upper left-hand corner of the window to be created, and the second pair represents the lower right-hand corner pixel coordinates of the window. The remainder of each line contains the series of commands to be executed once the window is created. Spaces or tabs may be used as separators within the lines of a configuration file.

Coordinates define the outer edge of the window border. Valid coordinates are 6,6 (the upper left corner of the screen) thru 1018,1018 (the lower right corner). Coordinates outside this range will be **clipped** to the screen. If all four coordinates are 0, however, the user will be prompted with the Sweep Cursor to define the position and size of the window. The windows specified must be at least as large as the minimum (32x32) window size. An error in a line of the configuration file will cause that line and the remaining lines in the file to be ignored.

To create a Windowproc window *m* lines by *n* columns, the window should be:

$(m * \text{font\_height}) + 34$  pixels high (difference in y coordinates)  
 $(n * \text{font\_width}) + 29$  pixels wide (difference in x coordinates)

The font used in Windowproc windows created from a configuration file is determined by the Font Size option for that logical host. The Small font is 7 pixels wide and 14 pixels high, the Medium font is 9x14, and the Large font is 11x16.

---

## Main Terminal Menu

**Note:** See Chapter 3 for help using the mouse.

The main terminal menu is presented when you depress Button 3 on the mouse. Most of the selections on the main terminal menu perform windowing operations.

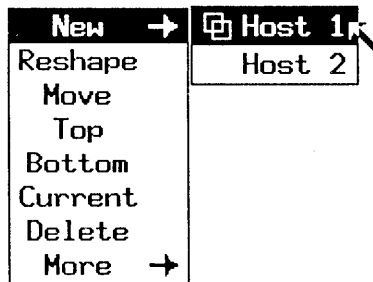

**Figure 4-5** 630 Main Terminal Menu







---

The menu "pops up" at the current mouse cursor position when Button 3 is depressed and disappears when Button 3 is released. A menu item is selected by positioning the mouse cursor over it (causing the item to be highlighted in reverse video) and releasing the button. Some operations, such as New, have submenus which further define them. The operation selection is always made at the lowest submenu level. Under certain circumstances a particular operation may not be allowed. If this is the case, the operation's name is displayed in half-intensity font and cannot be selected.

---

## Mouse Cursor





Many windowing operations cause changes in the mouse cursor. The cursors used are shown below.

Symbol	Name	Symbol	Name
	Arrow		Sweep Cursor
	Dead Mouse		Target Sight
	Coffee Cup		Skull

**Figure 4-6** Mouse Cursors

---

Some operations may also cause a "message box" to appear, replacing the mouse cursor. These highlighted rectangles contain text explaining why a particular operation failed or is not possible. A message box can be removed (returning the mouse cursor to its normal state) by clicking any mouse button. Message boxes and the circumstances under which they are displayed are described below.

MESSAGE BOXES (appear in reverse video)	CONDITIONS
	<p>Occurs when the terminal has insufficient memory. Can occur when creating a new window in: New, Setup, PF Edit, or Peel. The No Memory message may also occur while doing a Save, a Reshape, a Move, or when exiting layers, or doing a print operation from the menu.</p>
	<p>Occurs when the swept window is too small. Can occur when creating a window in: New, Reshape, Setup, or Peel.</p>
	<p>Attempt to reshape a non-reshapeable window.</p>
	<p>Attempt to delete last window to host. (layers and nonlayers)</p>

**Figure 4-7** Message Boxes

---

---

## Window Commands

### New

New windows can be created for either of the two logical hosts. Choose the host the window is to be associated with by depressing Button 3 and sliding across the New selection to either Host1 or Host2. Release Button 3 when the mouse cursor is over the desired host and the host name is highlighted. (If a host name is in half-intensity font, it cannot be selected because the host has not been assigned a physical port in Setup or else because no more windows are available to that host.) Once the logical host is selected, the mouse cursor changes to the Sweep cursor and an outline of the default window size for that host appears, as specified in Setup. (Only the outline will appear for a *non-layers* window if the "Fixed Non-Layers Window" setup value is Yes.)

Move the outline and cursor to the desired position by moving the mouse without depressing any button. Clicking Button 3 creates a window of the default size; moving the mouse while depressing Button 3 will sweep out a window of variable size depending on when the button is released. Clicking Button 1 or 2 cancels the operation. (See Figure 4-8 for creating a new window.)

New is allowed only if the logical host has been assigned a physical port in Setup and has remaining unused windows. In *layers* the maximum number of windows per logical host is seven. In *non-layers* only one window per logical host is available. The *layers* icon will appear beside the logical host name in the host submenu if a *layers* session is active on that host.

If there is not enough memory to create the window, New will display the "No memory" message box, and no window will be created. If the window swept out is less than the minimum size (32 pixels by 32 pixels), the "Swept window too small" message box will appear and no window will be created. If New succeeds, the window will be created and Windowproc (the native 630 terminal emulator --- see Chapter 5) will begin executing in it.

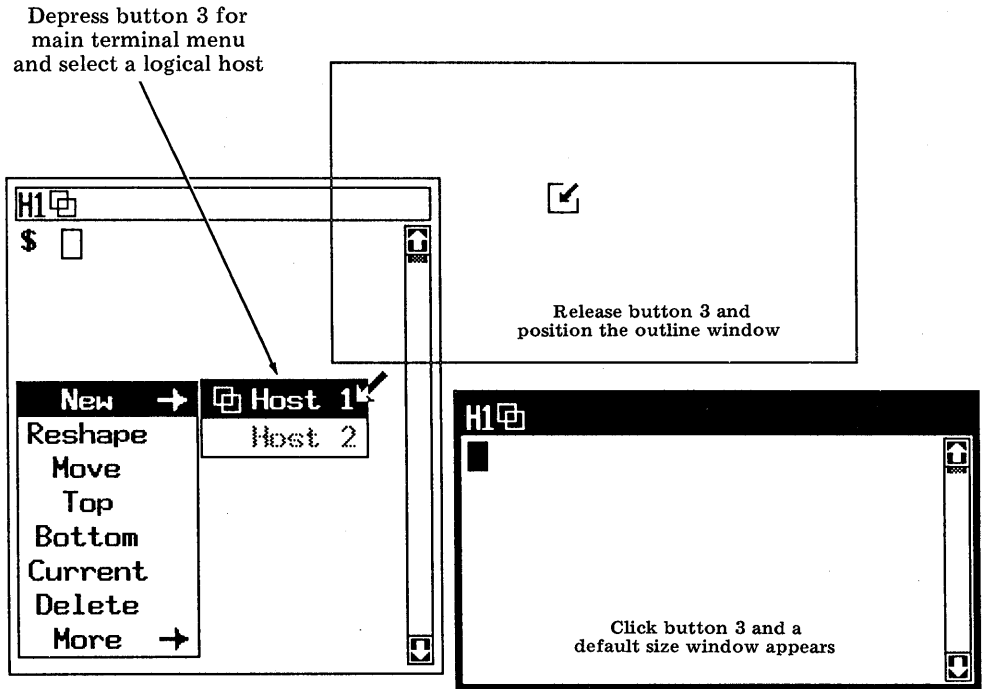

Figure 4–8 Creating a New Window

---



---

## Reshape

This operation changes the shape and location of a window on the screen. When Reshape is selected, the mouse cursor changes to the target cursor. Select the window to be reshaped by clicking Button 3 over it. Clicking Button 3 over a window which cannot be reshaped cancels the operation and causes the "Fixed size window: Cannot be reshaped" message box to be displayed; clicking over the screen background or clicking Button 1 or 2 cancels the operation. Once a valid window is chosen, the mouse cursor changes to the Sweep cursor and an outline of the default window size for that window's host appears. (If the window is local or no default size has been specified, only the Sweep cursor will appear. In this case, clicking Button 3 will cancel the operation.)

Move the outline and cursor to the desired position by moving the mouse without depressing any button. Clicking Button 3 reshapes the window to the default size; moving the mouse while depressing Button 3 will sweep out a window of variable size depending on when the button is released. Clicking Button 1 or 2 cancels the operation. (See Figure 4-9 for reshaping a window.)

Reshape of Windowproc windows is restricted to those which are either local or part of a *layers* session. Users who wish to override this restriction may do so by sending an escape sequence to Windowproc or by selecting "No" for the "Fixed Non-Layers Window" Setup option. Potential difficulties when using this option setting are discussed in Chapter 7. Even when Reshape is allowed, some programs (*vi*, for example) will not operate properly if the window is reshaped while they are running. Reshaping a Windowproc window to a very narrow size can take several seconds because of the time necessary to reformat the buffer lines.

If there is not enough memory to reshape the window, the "No Memory" message box will be displayed and the window will be reshaped to its original size and position.\* If the area swept out is

---

\* In rare cases, there may not be enough memory to restore the window's original size and a 32 pixel by 32 pixel window will be created instead.

smaller than the minimum window size (32 pixels by 32 pixels), the "Swept window too small" message box will appear and Reshape will do nothing.

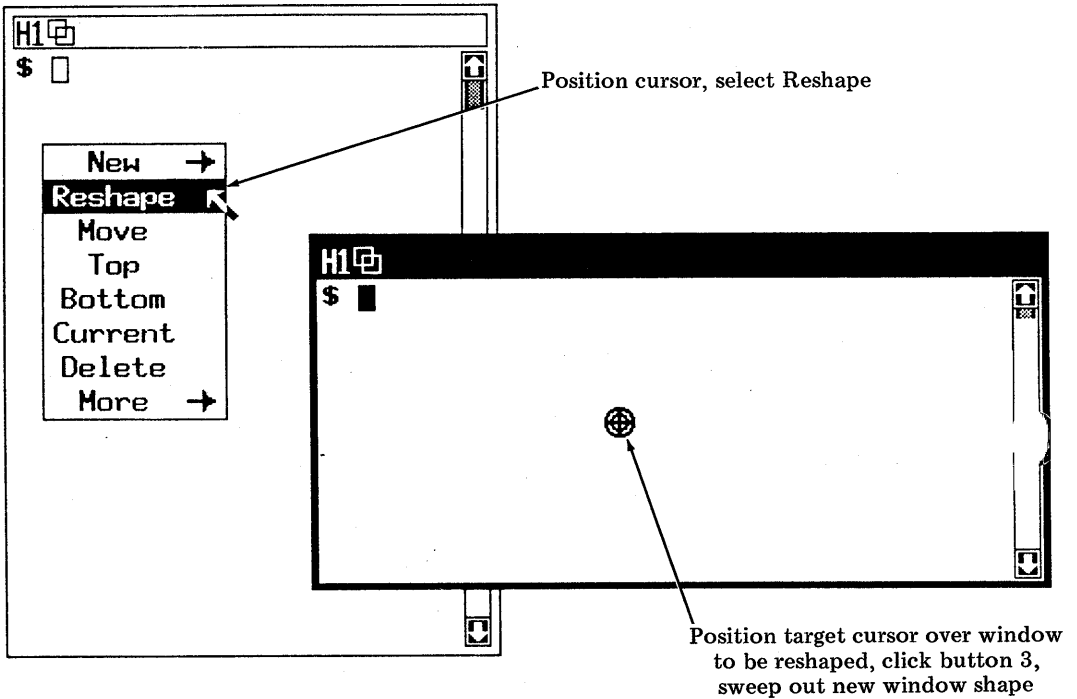

Figure 4-9 Reshaping a Window

---

## **Move**

This operation repositions a window without changing its shape or contents. Once Move is selected, the mouse cursor changes to the target cursor.

To choose the window to be moved, position the target cursor inside it and depress (and hold) Button 3. The mouse cursor changes to the 4-directional arrow cursor and an outline of the window follows the mouse movement. When you are satisfied with the new position, release the Button 3. The window will then be moved to the new position with its contents intact. To cancel the operation, click Button 1 or 2. (See Figure 4-10 for moving a window.)

Move will leave the window in its original position and display the "No Memory" message box if there is insufficient terminal memory to perform the operation.

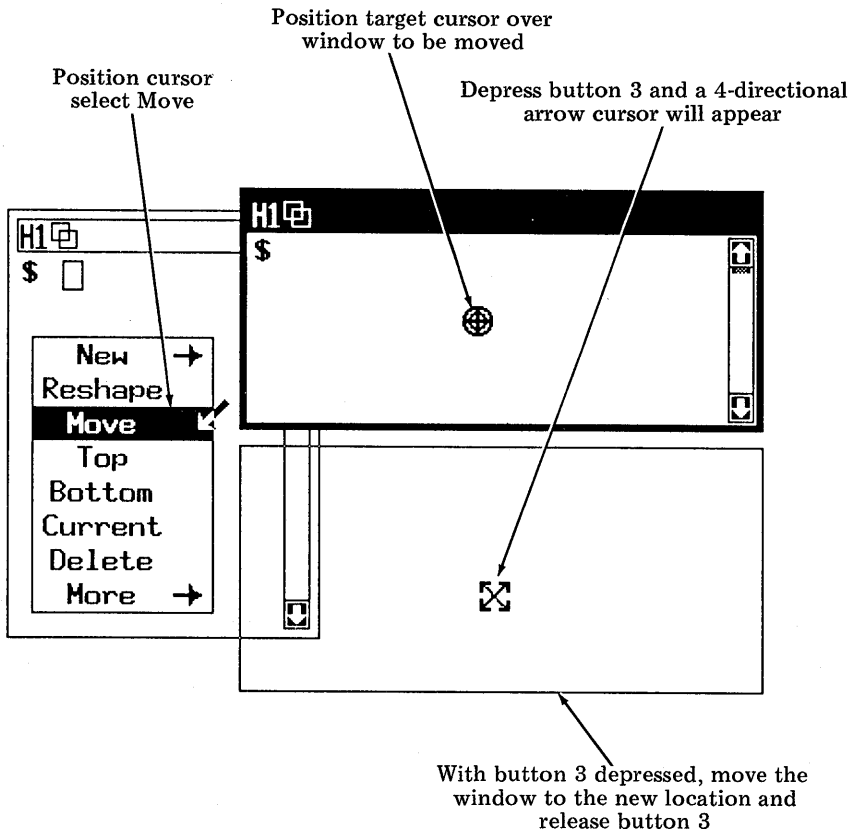

Figure 4-10 Moving a Window

---

## **Top**

This operation brings the selected window to the top, or "front", of the screen, so that it is not overlapped by other windows. Once Top is selected, the mouse cursor changes to the target cursor. Choose the window to be placed on top by clicking the target cursor over it (using Button 3); clicking over the screen background or clicking Button 1 or 2 cancels the operation. The other windows retain their relative positions.

## **Bottom**

This operation places the selected window at the bottom, or "back" of the screen, covering it with any overlapping windows. Once Bottom is selected, the mouse cursor changes to the target cursor. Choose the window to be placed on the bottom by clicking the target cursor over it (using Button 3); clicking over the screen background or clicking Button 1 or 2 cancels the operation. The other windows retain their relative positions.

## **Current**

This operation makes the selected window "current", causing keyboard and mouse input to be directed to the associated process and highlighting the window's border. Once Current is selected, the mouse cursor changes to the target cursor.

Choose the window to be made current by clicking the target cursor over it (using Button 3); clicking over the screen background or clicking Button 1 or 2 cancels the operation. (See Figure 4-11 for an example of a current window.)

**Note:** A non-current window can be made both top and current by clicking Button 1 in a visible part of the window.

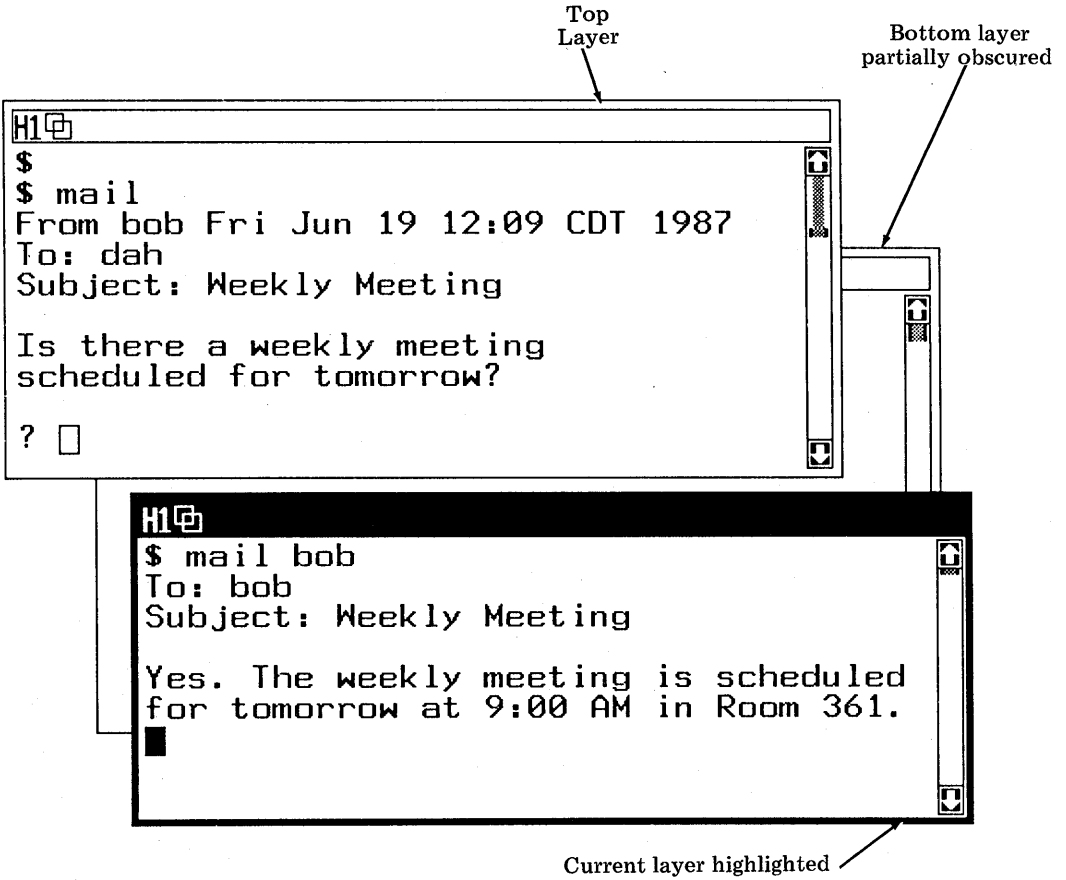

Figure 4-11 Current Window

---

---

## Delete

This operation removes a window and kills the process running in it. Once Delete is selected, the mouse cursor changes to the target cursor. Choose the window to be deleted by clicking the target cursor over it (using Button 3). Clicking over the last window to a logical host cancels the operation† and causes the "Delete not allowed: Sole window of active host" message box to be displayed; clicking over the screen background or clicking Button 1 or 2 cancels the operation.

## Exit

"Exit" is a less frequently used window operation and is found in the submenu under "More" on the main terminal menu. It is used to end the active *layers* session on a logical host; if no *layers* session is active on the host, it ends the host session itself.

In the case of a *layers* session, exit transforms the *layers* session to a *non-layers* session. All windows associated with the *layers* session are deleted and replaced by a single window executing the Windowproc terminal emulator and having characteristics identical to those specified in Setup for the default *non-layers* window to that host.‡ The *layers* icon will appear beside the logical host name in the exit host submenu if a *layers* session is active on that host.

In the case of a *non-layers* session, the change is from a *non-layers* session to a terminated session. The *non-layers* window disappears and the Data Terminal Ready signal on the physical connection is dropped, logging you off the host.

Choose which logical host is to be exited by depressing Button 3 and sliding across the More selection and then across the Exit selection to either Host1 or Host2. (If a host name is in half-intensity font, it

---

† The last window to a logical host can only be removed using the Exit command, which also terminates the *layers* or *non-layers* session running on the host.

‡ In the event that there is not enough memory to create the default *non-layers* window, a 32 by 32 pixel window will be created and the "No Memory" message box will be displayed.

cannot be selected because no session is active on that host.) The windows associated with that host will have a gray texture superimposed over them and the mouse cursor will change to a skull and crossbones (indicating the potential harm of the operation). Clicking Button 3 will cause the exit operation to continue (deleting all associated windows); clicking Button 1 or Button 2 will cancel the operation.



---

## Local Windows

Local windows are windows that have no host connection. The maximum number of local windows that you can create is bounded only by the amount of memory installed in the terminal. Use of local windows is restricted to programs that can function without host communication. Setup and PF Edit are examples of built-in programs which use local windows. Windowproc can also be made local, so that it functions as a "scratchpad" of previous work (See "Peel" in Chapter 5). Local windows are distinguished by a textured border.

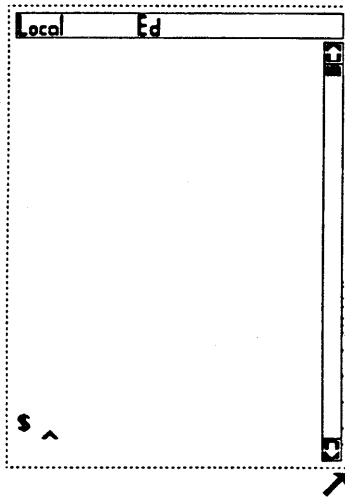

**Figure 4-12** Local Windowproc Window

---

# Chapter 5: Windowproc

---

## Contents

---

**630 Native Terminal Emulator** 5-1

---

**Appearance** 5-2

Text Area 5-3

Label Area 5-3

Scroll Area 5-5

---

**Windowproc Setup Options** 5-7

Windows 5-7

Buffer Enable 5-7

Window Size 5-8

Font Size 5-8

Fixed Non-Layers Window 5-8

---

**Mouse Operations in Windowproc** 5-9

Button 1 5-9

Button 2 5-12

Button 3 5-12

---

**Windowproc Operations** 5-13

Edit 5-13

Font 5-18  
Buffer 5-20  
Peel 5-20  
Print 5-22

---

**Programming in Windowproc** 5-23  
Programming the Label Area 5-23  
Programming the Menu 5-24

---

## 630 Native Terminal Emulator

Windowproc is the 630 native terminal emulator. A *terminal emulator* is a program which provides basic communication facilities between the host computer and the user; in particular it defines the terminal's response to certain character sequences. The character sequences recognized by Windowproc are a subset of the ANSI 3.64 ASCII sequences and are listed in Appendix A.

Each Windowproc window displays characters received from the host and saves the ASCII text in a character buffer. Only displayed characters, tabs, and newlines are saved in the buffer; character attributes are not retained. When the buffer is full, a new line added at the bottom causes the top line in the buffer to be discarded.

Two versions of Windowproc are available. The basic format is a simple terminal emulator which provides a window label, an on-screen text buffer, text printing, and user-selectable fonts. The enhanced version provides such additional features as local editing, off-screen text buffering and scrolling (optional), the ability to resend text to the host or another window, and the ability to create a local copy of the window.

Windowproc is native in the sense that it automatically runs in every window created by New. Since each window runs a copy of the Windowproc terminal emulator, the terminal effectively becomes many independent terminals.

---

## Appearance

All Windowproc windows are divided into three distinct areas: the text area, the label area, and the scroll area. The label area is located along the upper border of the window and the scroll area lies along the right border. The remainder of the window is the text area.

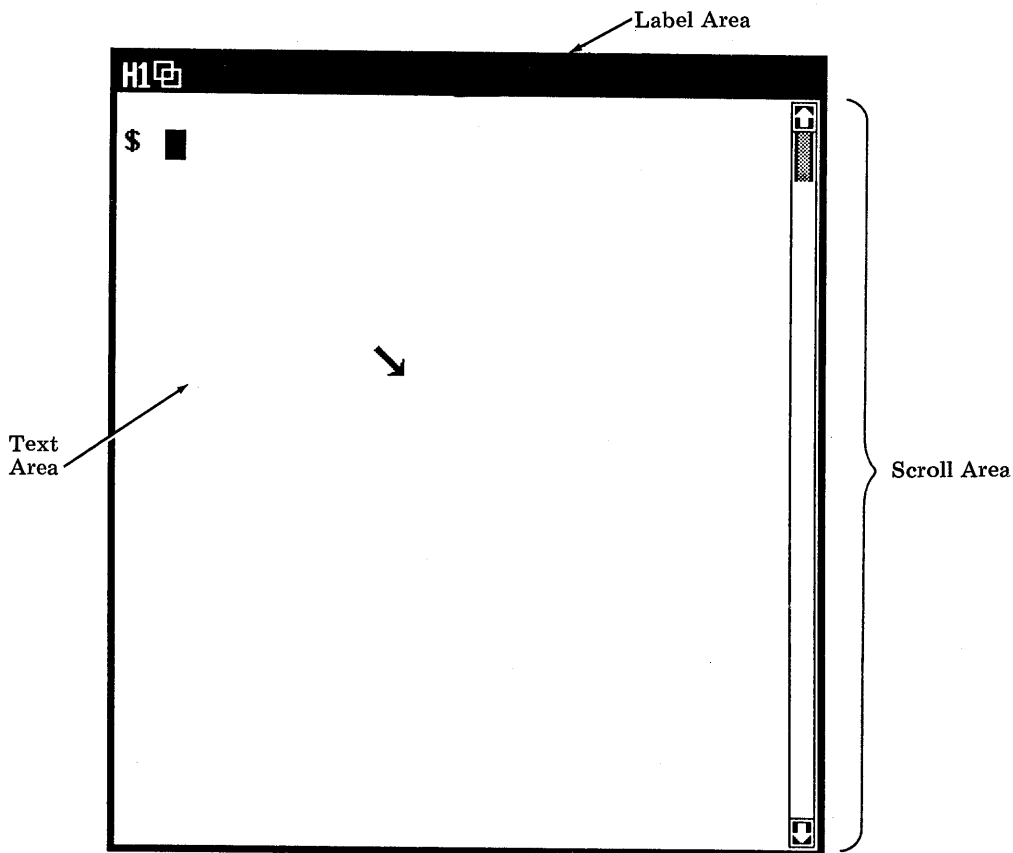

**Figure 5-1** Windowproc Window

---

---

## Text Area

Data received from the host is displayed in the text area. It extends from the upper left corner of the window (below the label area) to the point along the lower border of the window where the scroll area begins. A small part of the text area near each edge is left blank to enhance readability. The number of characters which can be displayed in the text area depends on the window's size and the font in use. Selecting the smallest resident font in a full screen window will display 69 rows and 140 columns of text.

## Label Area

The label area is divided into two parts. The first is an area used to indicate the current status of the window. The second area can contain text programmed using the `ESC [ ? v` escape sequence. See the example at the end of this chapter. If the window is too small, the label area may not be displayed in its entirety.

There are six icon fields in the label area as shown in Figure 5-2. The first two describe the host connection. The first denotes the window's logical host connection. The second icon appears only if the window is part of a *layers* session. These two icons are replaced by the "Local" icon if the window is not connected to a host.

The printer icon is displayed if the window has requested and been granted access to the printer. The next icon is displayed only if Scroll Lock is on for that window. Similarly, the Caps Lock icon appears only if Caps Lock is on for the window. The last icon is displayed if the window is in local edit mode.

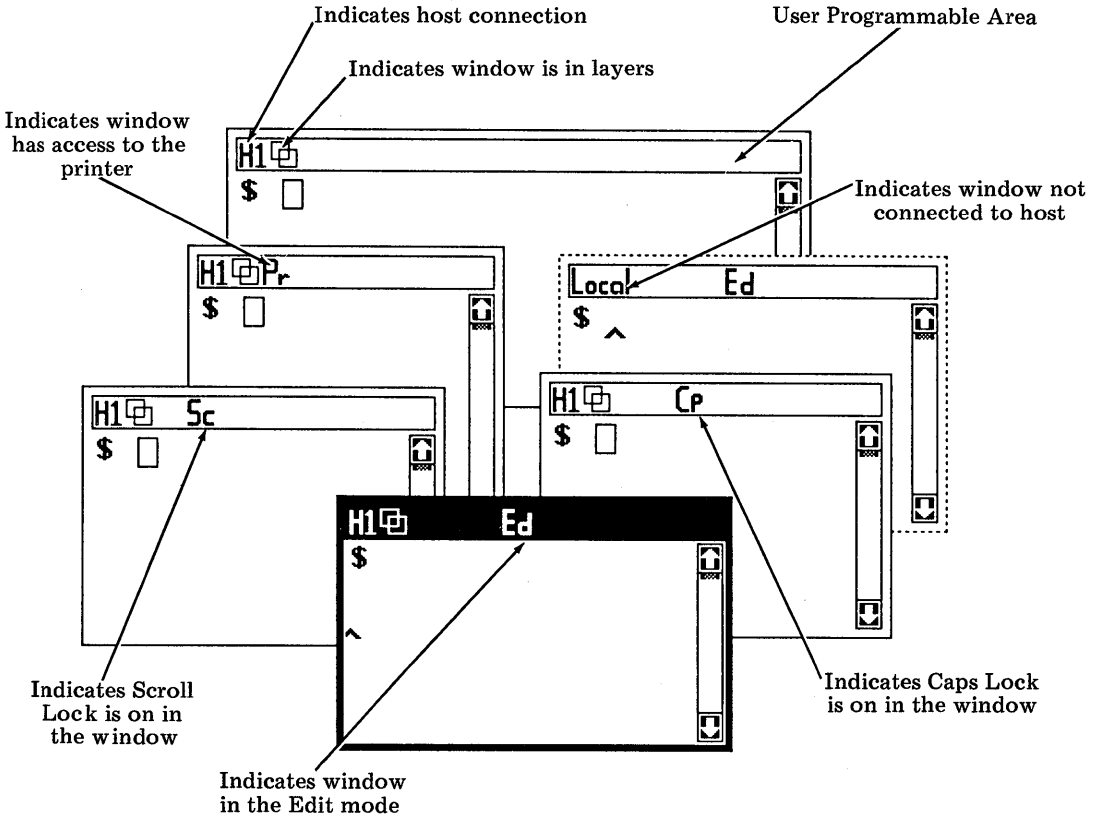

**Figure 5-2** Label Area

---

The second section of the label area can contain user programmable text. Initially this area is blank but can be modified by using escape sequences. Text in the label area is always displayed with the medium font and cannot be edited with the mouse.

## Scroll Area

The scroll area appears along the right edge of Windowproc windows. For basic Windowproc windows and enhanced Windowproc windows with buffering disabled, the scroll area is grayed, since no off-screen buffer is reserved. For enhanced Windowproc windows with buffering enabled, the scroll area contains the scroll bar and arrow icons and is used to select which part of the text buffer is displayed in the window.

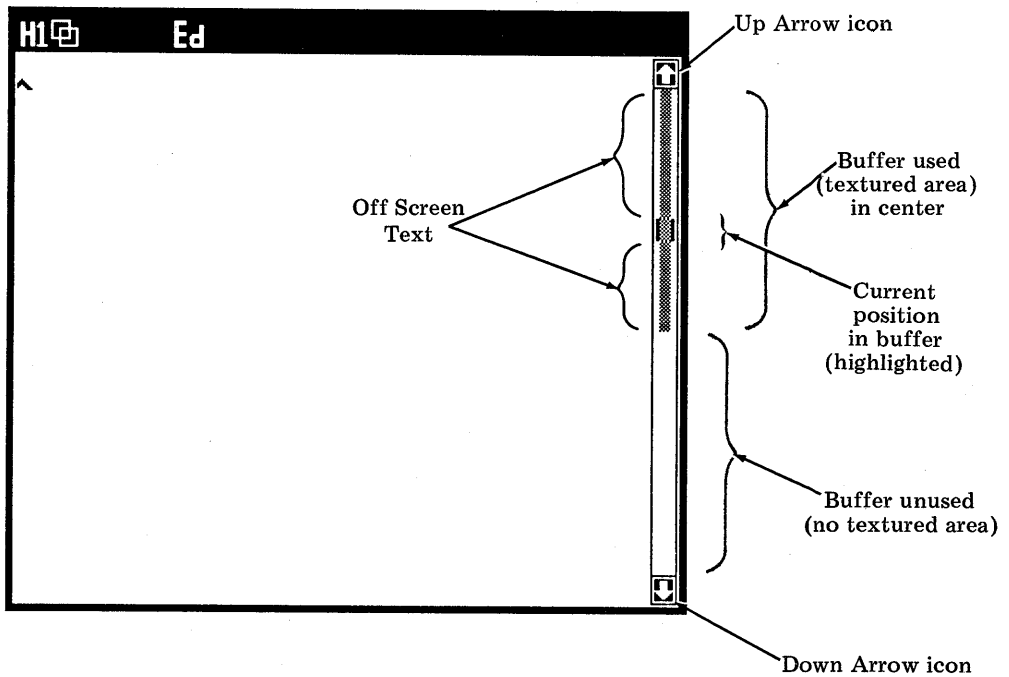

**Figure 5-3** Scroll Area



As shown on the previous page, the scroll bar for an enhanced Windowproc window with off-screen buffering enabled consists of several parts.\* The "current position" rectangle shows which part of the text buffer is displayed in the text region of the window. The textured region above and within it represents how much of the 10,240 byte buffer has been allocated for text. When the textured region reaches the bottom of the scroll bar, the buffer is full. Text will be discarded from the top of the buffer as needed thereafter to make room for new lines.

Scrolling is performed by depressing Button 1 within the scroll area. If the mouse is over the up arrow, depressing Button 1 will scroll in text from above one line at a time until the button is released or the top of the buffer is reached. Similarly, if the mouse is over the down arrow, text will scroll in from below, one line at a time.

If the mouse is within the textured area above the current position rectangle when Button 1 is depressed, the window will scroll by pages (screens) in that direction, either up or down, until the button is released or the end of the buffer is reached. If the mouse is within the rectangle itself when Button 1 is depressed, the rectangle will follow the mouse cursor to the part of the buffer you want displayed. When you release the button, the window will display that area of the buffer.

Scrolling places the window in edit mode, causing the mouse and text cursors to change and the edit icon to appear in the label area. The edit mode can be exited by pressing the Esc key or by clicking Button 1 twice without moving the mouse.

---

\* For windows less than 73 pixels high, the scroll bar texture and current position rectangle are not shown.

---

## Windowproc Setup Options

Several Terminal Setup options affect Windowproc windows. (See Chapter 7 Terminal Setup).

### Windows

The "Windows" option under "Display" determines whether the basic or enhanced version of Windowproc will be used. The default is enhanced.

### Buffer Enable

The "Buffer Enable" option under "Display" determines whether off-screen text buffer space will be reserved for new Windowproc windows. If off-screen buffer space is reserved, off-screen text can be brought back onto the screen using the scroll facilities. Setting this option to "Yes" does not mean that all windows will have off-screen buffer space reserved, since the buffer option can be turned on or off for each window using the "Buffer" item in the Button 2 Windowproc menu. The "Buffer Enable" option simply determines the default for new windows.

For a Windowproc window with off-screen text buffering, up to 10,240 bytes of memory can be allocated to hold on-screen and off-screen text. Otherwise, only enough memory is reserved to buffer the on-screen characters.†

---

† If terminal memory is insufficient to allow the creation of the on-screen text buffer, a message reading "No Memory: Free Memory to Continue" will be displayed in the bottom of the window. Windowproc will try to allocate memory again when the window is made current or reshaped or if a button is clicked in the window.

## Window Size

The default size for Windowproc windows (in characters) is determined by the Layers and Non-Layers "Cols" and "Rows" options. The window's size in pixels is then computed based on the current font size.

## Font Size

The "Font Size" option selects the default font to be used in new Windowproc windows. Not all windows will use the designated font, since a different font can be selected in a window using the "Font" item on the Button 2 Windowproc menu.‡ The "Font Size" option simply determines the default font for new windows. Along with "Cols" and "Rows", Font Size is used in determining the default size of new windows (in pixels).

## Fixed Non-Layers Window

Font changes and window reshape are allowed only if a window is local or part of a *layers* session. Changing the "Fixed Non-Layers Window" option setting to "No" overrides these restrictions but can cause difficulties which are discussed in Chapter 7 under the "Fixed Non-Layers Window" option description. These restrictions can also be overridden by the `ESC [ ? r` escape sequence (see Appendix A).

---

‡ Font cannot be changed in a *non-layers* window unless the "Fixed Non-Layers Window" option has been set to "No" or the window receives an escape sequence to change the font. See Appendix A.

---

## Mouse Operations in Windowproc

### Button 1

In addition to controlling scrolling, Button 1 is used to enter and exit the Edit mode and to sweep text. Its actions in Windowproc are summarized in the following table.

**Table 5-1** Button 1 Windowproc Operations

---

Button 1 Action	Result
click over noncurrent or partially hidden window (depress and release button without intervening mouse movement)	Makes that window top and current. If text is highlighted in another window when the button is clicked, it is saved in the global text buffer.
depress over up arrow	Causes text before the current text to be displayed. Scrolling cannot occur beyond the beginning of the text buffer.

Button 1 Action	Result
depress over down arrow	Causes text after the current text to be displayed. Scrolling cannot occur beyond the end of the text buffer.
depress over textured bar	Scrolls the window one page. If depressed above the on-screen rectangle, text scrolls in from above. If depressed below the on-screen rectangle, text scrolls in from below. Scrolling cannot occur beyond the beginning or end of the text buffer.
depress over the on-screen rectangle	Allows the user to drag the on-screen rectangle to the desired position in the buffer. For example, dragging it to the top and releasing Button 1 will cause the top of the text buffer to be displayed in the window.
click once in text area	Places the text cursor where the mouse is and puts the window in edit mode.

Button 1 Action	Result
click twice in the text area without intervening mouse movement (double click).	Takes window out of edit mode (unless the window is local).
depress in the text area and move the mouse before releasing (sweep)	Highlights in reverse video text moved over by the mouse and places window in edit mode. Some lines will end with a gray texture to show that a carriage return has been swept out with the line. Lines which do not end in this texture wrap around to the next line on the screen.

## Button 2

When depressed within a current Windowproc window, button 2 causes the following menu to be displayed.

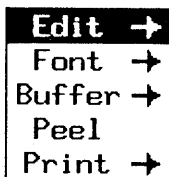

Figure 5–4 Windowproc Menu

---

These menu items are discussed separately under Windowproc Operations. Additions to this menu can be made using the `ESC [ ? x` escape sequence. See the example at the end of this chapter.

## Button 3

This button brings up the main terminal menu. (See Chapter 3 for more information on Button 3.)

---

## Windowproc Operations

The following operations are available in enhanced Windowproc: Edit, Font, Buffer, Peel, and Print. Print and Font are also available in basic Windowproc.

### Edit

In edit mode, Windowproc is not communicating with the host and local editing can be done on the window's text buffer. (Local Windowproc windows are, by definition, always in edit mode.) To enter edit mode, click Button 1 within the text area. Edit mode is indicated by changes in the shape of the text cursor (to a caret) and the mouse cursor (to an elongated "x") and by the appearance of the edit icon in the label area. The edit cursor can be moved by clicking Button 1 or using the arrow keys. Except in local windows, edit mode can be exited by selecting "Mode" on the Button 2 Windowproc menu under "Edit", pressing the Esc key or clicking Button 1 twice without moving the mouse. Unless it is local, a window which is in edit mode is automatically taken out of edit mode when it is made current. To return the window to its previous editing context choose "Mode" from the Edit submenu.

### Typing in Edit Mode

Initially, Windowproc acts like a terminal: characters received from the host are displayed and anything typed is sent to the host. But when the window is placed in edit mode, keystrokes are displayed locally and are not sent to the host. If text is highlighted in the window, typing characters will cause the highlighted text to be saved in the global save buffer and deleted from the screen and text buffer before the typed characters are inserted. Characters are inserted at the edit cursor position and lines are discarded from the top of the buffer as needed.

Control characters typed in edit mode are acted upon as if received from the host. Exceptions are ESC (which takes the window out of edit mode), Carriage Return (which inserts a newline), and any character preceded by a backslash (other than Carriage Return). Control



characters which are not acted upon are displayed regardless of the value of the "Controls" setup option.

### Global Save Buffer

Most local edit operations affect the global save buffer. The global save buffer is an area of storage in the terminal which is accessible to all Windowproc windows and to the PF Edit window. Text can be saved here for use in Paste or Send operations. These and other local edit operations are found in the Button 2 Edit submenu and are described below.

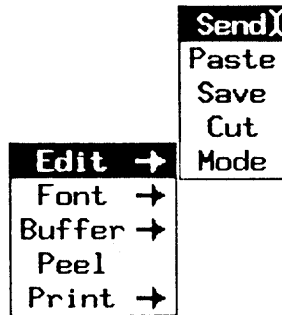

Figure 5-5 Edit Submenu

---

### Send

If there is text swept out, the Send operation copies that text into the global save buffer. The contents of the save buffer is then sent to the host. The sequence sent for a carriage return depends on the value of the "Return" setup option for that host. Characters echoed from the host as a result of executing the send command are placed at the host (text) cursor.

**Paste**

The Paste operation inserts the contents of the global save buffer at the location of the edit or host cursor depending on the state of the window. If there was text swept out at the time of the paste operation, that text is replaced by the text from the save buffer. Text shifted to the right as a result of the insertion is not lost, but may be wrapped onto another line. Pasted text is highlighted as if it had been swept out. Pasted text is not sent to the host, and any escape sequences contained in the text are displayed rather than acted on. The "No Memory" message box will be displayed if the paste cannot be completed because of lack of memory.

**Cut**

The Cut operation works with swept out text. The swept out text is copied into the global save buffer and deleted from the text buffer. No information is sent to the host.

**Save**

The Save operation works with swept out text. The swept out text is copied into the global save buffer. The text is not changed, but becomes unhighlighted. A "No Memory" message box is displayed if there is insufficient memory to allow the text to be saved. Highlighted text in the current window is automatically saved when another window is made current. No message is displayed if the automatic save fails because of insufficient memory.

**Mode**

If the window is in edit mode, it is taken out of edit mode and the text cursor is placed at the buffer and screen position it was in when the last on-line operation was performed. Text is scrolled if necessary.

If the window is not in edit mode, it is placed in edit mode and the cursor is placed at the buffer and screen position it was in when the last edit operation was performed.

Mode is grayed (not selectable) if the window is local or if the window has not yet been in edit mode.

### Using Local Edit

Following is an example of how local edit operations might be used. The user wants a listing of several files.

Suppose the command line is:

```
ls -l file.1 file.2 file.3
```

After typing this in, the user discovers this is not the directory containing these files. After changing to the proper directory, the user can avoid retyping the entire line by sweeping and sending it as follows:

- 1 Position the edit cursor to the beginning of the command line by clicking Button 1 while the mouse cursor is slightly below and to the left of the first letter in `ls`.
- 2 With the mouse cursor still in this position, depress and hold Button 1 while moving the mouse to the right so that the entire command line is highlighted in reverse video.
- 3 When the entire line has been "swept" in this way (including the gray texture representing the carriage return), release Button 1.

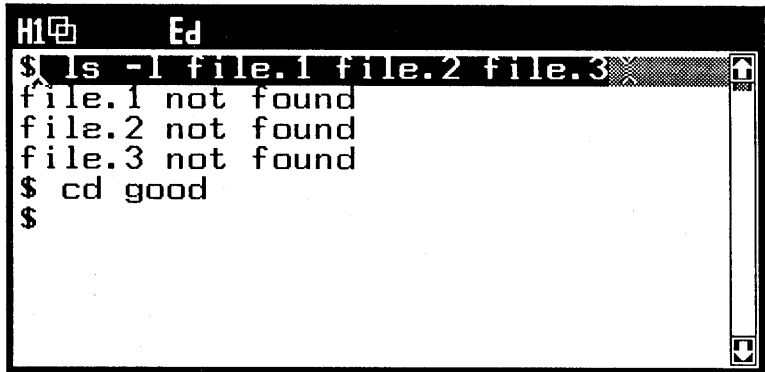

The image shows a screenshot of a terminal window titled "Ed". The window contains the following text:

```
$ ls -l file.1 file.2 file.3  
file.1 not found  
file.2 not found  
file.3 not found  
$ cd good  
$
```

The first line, "\$ ls -l file.1 file.2 file.3", is highlighted with a dark background, indicating it is the current line being edited or swept. The window has a standard Mac OS-style title bar with a close button (red square) and a scroll bar on the right side.

**Figure 5-6** Sweeping a Command Line

---

- 4 Depress Button 2 within the window, and position the cursor over "Edit" (so that it is highlighted in reverse video). Still depressing Button 2, slide the mouse to the right over the arrow beside "Edit", and position the cursor over "Send" (it will also be highlighted).

<b>Edit</b> →	<b>Send</b> ↵
Font →	Paste
Buffer →	Save
Peel	Cut
Print →	Mode

**Figure 5-7** Selecting Send

---

- 5 Release Button 2 to select Send. The command line will be sent just as if it had been typed from the keyboard.

## Font

Three resident fonts are available for use in Windowproc windows; others can be downloaded from the host using software contained in the 630 MTG Software Development Package. By default, Windowproc uses the resident font specified by the Font Size option in Setup. The font used in a window can be changed through the Font submenu on Button 2 or with an escape sequence (See Figure 5-8).

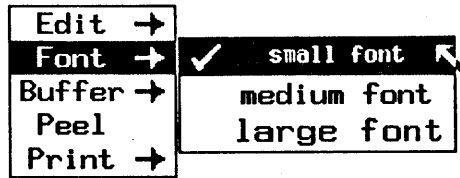

**Figure 5-8** Font Submenu

The Font submenu lists all possible fonts that the window can use (resident fonts plus any fonts downloaded from the host). The font names are written in the font that they represent, unless the font is very large or does not contain the characters needed to write the name. The currently selected font is designated by a check mark in front of its name. When a font is selected, the window is cleared and redrawn with that font. This may result in a different number of characters displayed in the window depending on the relative cell sizes of the old and new font. It may also result in relocation of the text or edit cursors. If the window is narrow, a font change may take several seconds to complete. Font changes are not allowed if a window is not reshapable.

## Buffer

The Buffer operation enables or disables off-screen buffering for the window. The default setting for new windows is specified by "Buffer Enable" under "Display" in Setup.

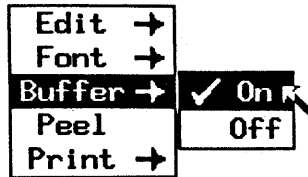

Figure 5-9 Buffer Submenu

---

Disabling off-screen buffering causes any off-screen text to be thrown away and the scroll area to be grayed. Selecting "Buffer Off" also causes a window to return from local edit mode. Enabling off-screen buffering causes data scrolled off the screen to be saved (up to 10,240 characters) and re-activates the scroll area.

## Peel

Peel is used to create a local Windowproc window. When Peel is selected, the mouse cursor will change as if for a reshape. Clicking Button 2 or sweeping out an area with Button 2 will create a local window containing a copy of the current window's buffer. §

---

§ If the area swept out is smaller than the minimum window size (32 pixels by 32 pixels), the operation will be cancelled. If not enough memory is available to perform the Peel, the "No Memory" message box will be displayed and the Peel will do nothing.

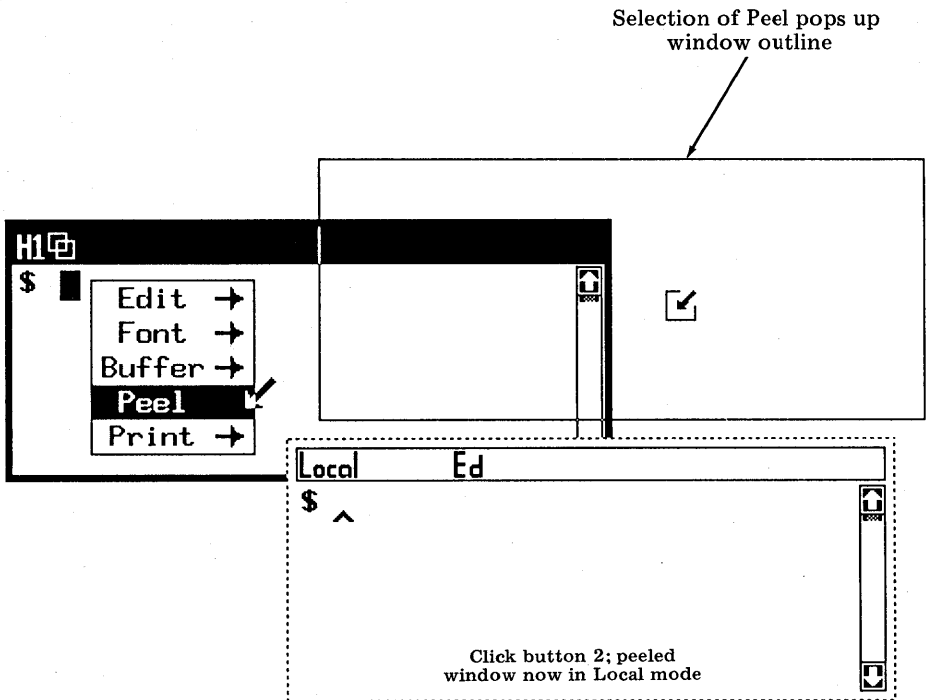

**Figure 5-10** Peeling a Window

---

The original window's buffer and screen is then cleared, although it remains current. The operation, then, effectively "peels" off a local copy of the window. A local Windowproc window is always in edit mode since there is no host connection. Peel is only available for enhanced Windowproc windows.



## **Print**

The Print operation supports printing of text from a Windowproc window. It is available in both the basic and enhanced versions of Windowproc. Printing is described in detail in Chapter 6.

---

## Programming in Windowproc

This section of the chapter shows examples of using the programmable features of Windowproc. When the terminal runs out of memory, the sequences sent to implement these features will be ignored by Windowproc.

### Programming the Label Area

The following example is a shell program which creates a shell function for displaying the current directory in the label area. Type this program into a file called "setpd":

```
pd()
{
    cd $*
    dir=`pwd`
    size=`expr "$dir" : '.*'^`
    echo "\033[?$size;2v$dir\c"
}
pd
```

When you open a new window, type ". setpd". This will "install" the pd function in your current shell and display your current directory in the right hand corner of the label area. After that whenever you change directory using the pd command rather than the cd command, your new directory will be displayed in the label area.

## Programming the Menu

The programmable menus feature of Windowproc allows the user to add custom commands to Windowproc's Button 2 menu. Following is an example of how the feature might be used. Type the shell program into a file; execution of this file modifies the Button 2 Windowproc menu to include vi commands for moving the cursor.

```
# Program Vi Commands for Cursor Movement

echo "\033[?0;0;0x\c"      #Clear previous menu entries.
echo "\033[?2;0;0xVi\c"    #These commands will be grouped under Vi.
echo "\033[?2;1;1xUpk\c"   #Cursor Up
echo "\033[?4;1;1xDownj\c" #Cursor Down
echo "\033[?4;1;1xLefth\c" #Cursor Left
echo "\033[?5;1;1xRightl\c" #Cursor Right
```

**Note:** An explanation of this notation can be found in Appendix A:  
CONTROL CHARACTERS and ESCAPE SEQUENCES

# **Chapter 6: Printing**

---

## **Contents**

---

**Introduction** 6-1

---

**Printing Using Windowproc Menus** 6-2

---

**Printing Using Escape Sequences** 6-4

---

**Supported Printers** 6-6

5310/5320 Teleprinters 6-6

AT&T 475 and AT&T 476 6-8

---

**Printer Cables** 6-11

---

## **Introduction**

The most frequent configuration for local printing is to attach the printer to the AUXILIARY port (as opposed to a printer attached to a computer). The printer must have a serial or serial to parallel, RS232C compatible interface for direct attachment to the AUXILIARY port.

Text printing can be accomplished in two ways: with menu selection or with escape sequences.

---

## Printing Using Windowproc Menus

The Windowproc Print operation supports printing of text from a window to a printer attached to the Aux EIA port. It is available in both the basic and enhanced versions of Windowproc. (Windowproc is described in detail in Chapter 5.) Both local and on-line printing are available in the print submenu. The currently selected print operations are indicated by check marks in front of the operation names.

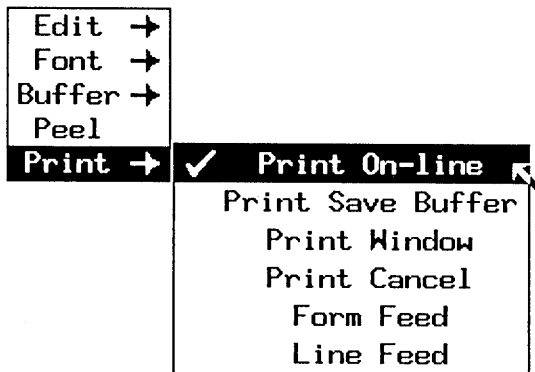

**Figure 6–1** Windowproc Print Submenu

---

A Print On-line selection assigns the printer to the Windowproc window, and host traffic received for that window is printed until Print Cancel is selected. Other print operations (Print Window, Print Save Buffer, Form Feed, or Line Feed) can be selected even while Print On-line is still active. The Print Save Buffer (see Chapter 5 Windowproc operation for details about the Global Save Buffer) command prints text that is in the global save buffer. If text is swept out when this command is executed, it will first be placed in the global save buffer and then printed. Print Window causes the on-screen contents of the Windowproc window to be printed. Print Cancel cancels any previous print command.

These operations, along with Form Feed and Line Feed, are found in the Print submenu, which is summarized in the following table.

**Table 6–1** Windowproc Print Summary

---

MENU ITEM	DESCRIPTION
Print On-Line	Causes host data received in this window to be sent to the printer
Print Save Buffer	If data is swept out of the window, it is placed in the Save Buffer and sent to the printer; otherwise, the current contents of the Save Buffer will be sent to the printer.
Print Window	Causes on-screen contents of the window to be printed.
Print Cancel	Terminates printing, regardless of whether it was initiated by a menu selection or an escape sequence.
Form Feed	Sends a form feed and carriage return to the printer.
Line Feed	Sends a carriage return and line feed to the printer.

A "No Memory" message box will be displayed if there is not enough memory to perform the selected operation.

---

## Printing Using Escape Sequences

Three pairs of control sequences can be used to enable and disable the printer. These sequences cannot be intermixed in usage. They will be ignored if the printer has already been requested by another window. The Windowproc "Print Cancel" selection will also turn off printing initiated by a control sequence.

- DC2 (0x12)  
Turn printer on line. Text will be displayed in the window as well as being sent to the printer.
- DC4 (0x14)  
Turn printer off line.
- ESC [ ? 5 i  
Turn printer on line. Displays everything in the window that is sent to the printer. (Same as DC2)
- ESC [ ? 5;1 i  
Same as ESC [ ? 5 i, but returns ESC [ ? ps i where:  
    **ps** = 0 indicates printer was not granted  
    **ps** = 1 indicates printer was granted
- ESC [ ? 4 i  
Turn printer off line. (Same as DC4)
- ESC [ 5 i  
Turn printer on line (media copy mode). Send all typed keystrokes to the host and the printer; text will not be displayed in the window. Tab Expand and Filter Escapes Setup options will be ignored (all escapes will be sent and tabs will not be expanded).



- ESC [ ? 5;2 i

Same as ESC [ 5 i, but returns ESC [ ? ps i where:

**ps** = 0 indicates printer was not granted

**ps** = 1 indicates printer was granted

- ESC [ 4 i

Turn printer off line. (Same as DC4)

---

## Supported Printers

Any EIA printers that support XON/XOFF flow control are suitable for use with the 630. Option settings for the 5310/5320 Teleprinters and the AT&T 475 and 476 printers are given below.

### 5310/5320 Teleprinters

Options for the 5310/5320 Teleprinters are set with the LCD display and buttons on the front of the printer. These two printers are listed together because their options are identical. Consult the manual accompanying the printer for further information about setting options. When using the 5310/5320 Teleprinters with the 630, the printer port should be optioned to no parity, 9600 baud, and 8 bit characters. If even or odd parity is selected instead, 7 bit characters must also be chosen.

Table 6-2 5310/5320 Options

5310/5320 OPTIONS		
OPTIONS	SETTINGS	Notes
CPI	10	4
LPI	6	4
FLGT	66	4
LGMN	1	4
RMGN	80	narrow paper
	132	wide paper
TMGN	1	4
BMGN	66	4
CHAR	ASCII	4
ALTF	LINE	4
WRAP	YES	4
PCTL	NO	2
EMUL	ANSI	2
VIEW	MAN	2
LFON	NO	1
CRON	NO	1
CLHT		3
CLVT		3
HTAB	DON'T CARE	4
VTAB		3
CMOD	NOMD	1
PRTY	NONE	2
BAUD	9600	2
FLOW	CHAR	1
SRTS	EIA	3
DC24	NO	1
DALM	NO	4
DEOT	NO	4
LP	NO	4

<b>5310/5320 OPTIONS</b>		
OPTIONS	SETTINGS	Notes
ECHO	NO	1
RTRN		3
AUT1		3
AUT2		3
AUT3		3
AUT4		3
AUT5		3
AUT6		3

**Notes:**

- 1 Mandatory
- 2 Recommended
- 3 Not applicable
- 4 Your choice (Default options are listed in most cases.)

**AT&T 475 and AT&T 476**

Options for the AT&T 475 and 476 are set by changing two sets of dip switches inside the top of the printer. One set of switches is on the right near the front of the printer, and the other set is on the right near the back of the printer. These two printers are listed together because their options are identical. Consult the manual accompanying the printer for further information about setting options. When using the AT&T 475 or 476 with the 630, the printer port should be optioned to even parity, 9600 baud, and 8 bit characters.

**Table 6-3** 475/476 Options

<b>475/476 OPTIONS</b>		
<b>OPTIONS</b>	<b>SETTINGS</b>	<b>Notes</b>
SW1-1	OPEN	2
SW1-2	CLOSED	2
SW1-3	OPEN	2
SW1-4	OPEN	2
SW1-5	CLOSED	2
SW1-6	CLOSED	2
SW1-7	CLOSED	2
SW1-8	OPEN	1
SW2-1	CLOSED	2
SW2-2	OPEN	1
SW2-3	OPEN	2
SW2-4	OPEN	2
SW2-5	OPEN	2
SW2-6	OPEN	1
SW2-7	CLOSED	3
SW2-8	OPEN	1
SW21-1	OPEN	1
SW21-2	OPEN	1
SW21-3	OPEN	1
SW21-4	OPEN	1
SW21-5	DON'T CARE	3
SW21-6	CLOSED	1
SW21-7	OPEN	1
SW21-8	CLOSED	1
SW22-1	OPEN	1
SW22-2	OPEN	1
SW22-3	OPEN	1
SW22-4	DON'T CARE	3

<b>475/476 OPTIONS</b>		
<b>OPTIONS</b>	<b>SETTINGS</b>	<b>Notes</b>
SW23-1	CLOSED	1
SW23-2	OPEN	1
SW23-3	OPEN	2
SW23-4	OPEN	2
SW23-5	CLOSED	2
SW23-6	DON'T CARE	3
SW24-1	OPEN	2
SW24-2	CLOSED	2
SW24-3	OPEN	2
SW24-4	CLOSED	2
SW24-5	CLOSED	2
SW24-6	OPEN	2
SW24-7	OPEN	2
SW24-8	CLOSED	2

**Notes:**

- 1** Mandatory
- 2** Recommended
- 3** Your choice

---

## **Printer Cables**

See Chapter 1 for information on ordering cables for connecting the following printers to the Auxiliary EIA Port on the 630 terminal: 5310/5320 Teleprinters, AT&T 475, and AT&T 476.

# **Chapter 7: Terminal Setup**

---

## **Contents**

---

**Introduction** 7-1

---

**Entering Setup** 7-2

---

**Viewing and Modifying Options** 7-6

---

**Default Settings** 7-14

---

**Exiting Setup** 7-16

---

**Notes on Use of Setup** 7-17

---

**Power On Configuration** 7-18

---

**Sample Configuration 1 --- Changing Baud** 7-20

---

**Sample Configuration 2 --- Multiple Hosts** 7-21



---

## Introduction

In the 630, a distinction is made between how a connection will be used (**logical device**) and the connection itself (**physical port**). Understanding this distinction will help in understanding the way Terminal Setup operates.

A logical device is a placeholder; it allows us to associate certain characteristics with a host, for example, without specifying which physical port is actually being used to access that host. The printer is also a logical device.

Terminal Setup is used for several purposes:

- To assign logical devices to physical ports.
- To set options such as parity and flow control for physical ports.
- To select terminal characteristics such as screen background color and keyboard repeat rate.

---

## Entering Setup

**Note:** See Chapter 3 for help using the mouse.

To initiate Setup:

- 1 Position the arrow cursor over the screen background, depress Button 3, and position the cursor over "More".
- 2 Still holding Button 3 down, slide the mouse to the right until the mouse cursor is within the "More" submenu.
- 3 Position the cursor over "Setup" and release Button 3. The outline of the Setup window will appear.\*
- 4 Move the mouse to position the window as desired or reshape it by sweeping as you would for a New window (See Chapter 4). (Since Setup menus read from left to right, it is generally preferable to position the Setup window near the left side of the screen.)
- 5 When the window is positioned click Button 3. The Setup icon, terminal firmware date and version, and amount of RAM available will be displayed in the window.†
- 6 To activate the Setup menu, position the mouse cursor over the icon and depress Button 1 until the icon becomes highlighted.

---

\* Choosing Setup from the main terminal menu when the Setup window already exists will cause the Setup window to become Top and Current.

† The "Swept window too small" message box will be displayed if you choose not to use the default size for the Setup window but fail to sweep out an area at least as large as the minimum window size (32 pixels by 32 pixels).

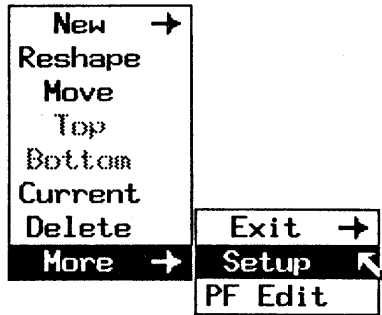

**Figure 7-1** Selecting Setup

---

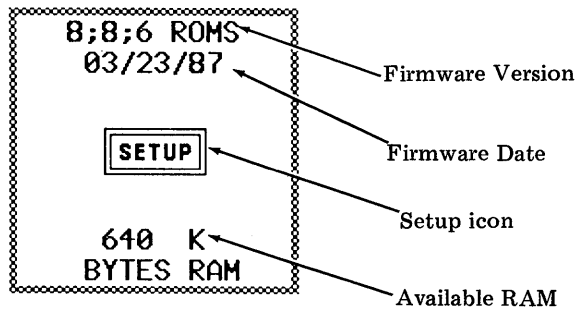

**Figure 7-2** Setup Window

---

- 7 When Button 1 is released, the first level Setup menu will appear.‡

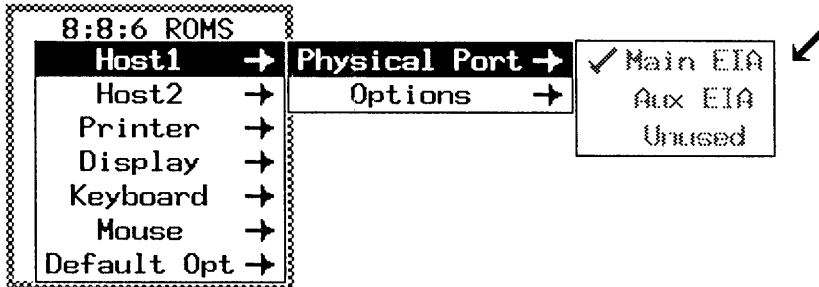

**Figure 7–3** First Level Setup Menu

‡ Setup uses *static* menus, which are discussed in Chapter 3. If terminal memory is insufficient to allow the creation of this menu, a message reading "No Memory: Free Memory to Continue" will be displayed in the bottom of the Setup window. Setup will try to allocate memory again when the window is made current or reshaped or if a button is clicked in the window.

---

## Viewing and Modifying Options

Terminal setup options are viewed or modified using the mouse; typing on the keyboard when the Setup window is current will cause the bell to ring. The current setting for an option is indicated by a check mark in the menu and may be viewed by positioning the mouse over the arrow to the right of the option in question. Values for terminal options are selected from the Setup menu by clicking Button 1 while the mouse cursor is over the desired value. The check mark will change to reflect the new value, confirming the selection. Available options are described below; changes in settings take effect immediately unless noted otherwise.

**Note:** Options which are marked with † apply only to Windowproc windows.

For each logical host device (Host1 and Host2):

- Physical Port - Defines which physical port will be associated with the logical host device. This option cannot be selected while any windows are active on the logical host device. Once a physical port is associated with a logical device, that physical port is unavailable to other logical devices. (See Chapter 1 for cable information on connecting the 630 terminal to a host.)
- Options - (Refer only to EIA ports: Main EIA, Main2 EIA, and Aux EIA)
  - Speed - Sets line speed (in bits per second) for the physical port. It should be matched with the speed of the attached modem/host.
  - Parity - Determines the state of the eighth or ninth bit (depending on the setting of the Bits/Char option). If "None" is selected, only the number of bits selected by the Bits/Char option is transmitted; no additional parity bit is transmitted. If set to "Odd" or "Even", an additional bit is transmitted that indicates the parity of the data. Parity should be set to "None" (the default)

for use with the AT&T Windowing Utilities package. A possible exception is when transmission is over a local area network which requires encoding; it may have different parity requirements.

- Bits/Char - Selects the size of the data portion of each character (i.e. does not include parity and start/stop bits). Bits/Char should be set to "8" (the default) for use with the AT&T Windowing Utilities package. A possible exception is when transmission is over a local area network which requires encoding; it may have different character size requirements.
- Rcv Flow - Selects whether DC3 (ASCII 0x13) and DC1 (ASCII 0x11) are to be treated as flow control characters on receipt. If this option is set to "On", receipt of DC3 will cause the terminal to halt transmission of characters until a DC1 is received. If "Off" (the default), DC3/DC1 are not treated specially. In the *layers* environment, this option is ignored unless the Encoding option is also enabled.

**Caution:** The Rcv Flow option should normally be set to "Off". An exception is if the terminal is attached to a local area network or host which generates DC1/DC3 flow control. A spurious DC3 character received when this option is enabled will cause the terminal to stop sending data to that host, creating a "deadlock" situation. Should this happen, setting the option back to "Off" will restart transmission to the host.

- Local Echo - When set to "Off", keystrokes are sent on-line but are not sent to the display, and data received from the line is displayed. Therefore, in order to view data transmitted from the keyboard, the host must be set to echo that data to the terminal. When set to "On", keystrokes are sent on-line and to the display simultaneously. Therefore, the host echo is not required to view data transmitted from the keyboard. UNIX System hosts generally require Local Echo Off (full duplex), which is the default. For non-UNIX hosts,

change this option only if you are certain your host requires it. In the *layers* environment, this option is ignored and the host line is always run in full duplex mode.

- **Encoding** - Selects whether the data communications path will reliably transmit all 8-bit ASCII characters. Certain local area networks use ASCII control characters for internal signalling, and will not reliably transmit these characters. Since the protocol used in the *layers* environment can embed these ASCII control characters within messages, the communications system must be prevented from interpreting these characters. If the "Encoding" option is "On", data transmitted by the terminal in the *layers* environment is encoded to prevent any ASCII control characters (ASCII code < 0x20) from occurring. Data arriving from the host when "Encoding" is "On" is assumed to be similarly encoded and is automatically decoded by the low-level terminal I/O system.

To determine whether "Encoding" should be "On", answer the following two questions:

- 1 Does the communications system always transmit *all* eight-bit ASCII characters?
- 2 Does the communications system use ASCII DC1/DC3 or ASCII ENQ/ACK for internal flow control?

If the answer to either of these questions is "yes", you should set the "Encoding" option "On". Otherwise, it should be set to "Off".

- **Gen Flow** - Selects whether the terminal should generate ASCII DC1/DC3 characters to halt transmission by the host or communications controller. If Gen Flow is "On" (the default), the terminal will automatically generate an ASCII DC3 character when the internal buffer nears capacity. An ASCII DC1 character is automatically transmitted when the buffer



is nearly empty. If it is set to "Off" or if the host does not recognize the DC1/DC3 characters, the host can overrun the terminal's input buffer, causing characters to be thrown away and the bell to ring. Gen Flow should be left "On" unless receipt of DC1/DC3 causes problems on the host.

The Gen Flow option only applies to the *non-layers* environment, since flow control is handled automatically by the protocol in the *layers* environment.

- Return - Selects the sequence sent by the "Return" key on the keyboard. "CR" sends a CR (ASCII 0x0d); "CR/LF" sends a CR followed by an LF (ASCII 0x0a); "LF" sends an LF. These correspond to the UNIX System stty flags of "-igncr icrnl", "igncr icrnl" and "-inlcr", respectively. The option should be set to CR (the default) in most cases.
- Received Newline - Selects the action caused by a received newline (ASCII 0x0a). "LF" (the default) causes an advance to the same position on the next screen line; "CR/LF" causes an advance to the beginning of the next screen line.
- Font Size† - Defines which resident font will be used in new windows. Three fonts are available: Small (7x14 pixels), Medium (9x14 pixels), and Large (11x16 pixels).
- Layers Window Cols† - Defines the number of columns of text that will be displayed in new layers windows. Also defines the number of columns used to derive the outline size for layers windows which are reshaped.
- Layers Window Rows† - Defines the number of rows of text that will be displayed in new layers windows. Also defines the number of rows used to derive the outline size for layers windows which are reshaped or peeled.
- Non-Layers Window Cols† - Defines the number of columns of text that will be displayed in a new non-layers window. Also defines the number of columns used to derive the outline size for non-layers windows

which are reshaped or peeled. Modifying the Non-Layers Cols option will cause some programs (those which rely on *terminfo*) to work incorrectly. Chapter 9 contains a description of how to write a local *terminfo* to correct this.

- Non-Layers Window Rows† - Defines the number of rows of text that will be displayed in a new non-layers window. Also defines the number of rows used to derive the outline size for non-layers windows which are reshaped or peeled. Modifying the Non-Layers Rows option will cause some programs (those which rely on *terminfo*) to work incorrectly. Chapter 9 contains a description of how to write a local *terminfo* to correct this.
- Fixed Non-Layers Window† - Determines if non-reshapability will be enforced in the non-layers window. For correct operation programs like *vi* require a window whose size is fixed and based on the UNIX *terminfo* description. This option is provided to prevent unintentional reshape of a window because doing so will cause such programs to work incorrectly. The default "Yes" will prevent the non-layers window from being reshaped by mouse operations. The window can be made reshapable (overriding this option) by receipt of the `ESC [ ? r` escape sequence and can in any case be reshaped by the `ESC [ ? s` escape sequence.

Use caution when setting the Fixed Non-Layers Window option to No. Subsequent Reshape operations on the *non-layers* window will cause programs which rely on *terminfo* to work incorrectly. (A local *terminfo* will not correct this problem.)

The Fixed Non-Layers Window option takes effect with the next reinitialization of *non-layers* on the host (at power , after selftest, or upon exit of *layers* or *non-layers* on that host).

For the Printer:

- Port - Determines whether or not the logical printer device will be assigned a physical port (the Aux EIA port).
- Options -
  - Speed - Sets line speed (in bits per second) for the physical port. It should be matched with the speed of the attached printer.
  - Parity - Determines the state of the eighth or ninth bit (depending on the setting of the Bits/Char option). If "None" is selected, only the number of bits selected by the Bits/Char option is transmitted; no additional parity bit is transmitted. If set to "Odd" or "Even", an additional bit is transmitted that indicates the parity of the data.
  - Bits/Char - Selects the size of the data portion of each character (i.e. does not include parity and start/stop bits).
  - Expand Tabs† - Determines whether or not to replace tabs sent to the printer with an equivalent number of spaces. If "Yes" (the default), detection of a tab in data being sent to the printer causes the following sequence of actions: the number of characters to the next tab stop is computed, that many spaces are inserted in the data, and the tab character is removed. Tab stops are assumed to be 8 spaces apart, at columns 8, 16, 24, 32, 40, 48, 56, 64, 72, 80, and 88. This option is ignored if the printer is in media copy mode.
  - Filter Escapes† - Determines whether or not to filter escape characters. If "Yes" (the default), all Esc characters (ASCII 0x33) will be removed in data sent to the printer. This option is ignored if the printer is in media copy mode.

**Display** - Used to set display-related options.

- **Background** - Determines whether screen background will be amber (light) or black (dark).
- **Cursor** - Determines whether or not the text cursor in Windowproc and PF Edit will blink.
- **Controls†** - Determines how control characters which produce no action will be displayed (visibly, invisibly, or as spaces). Control characters which are processed by the terminal in some way are not displayed. Control characters which are already on the screen are not affected by a change in this option setting.
- **Windows†** - Determines whether Windowproc will have local edit capability (enhanced) or not (basic). A change in this option takes effect the next time the terminal is powered on.
- **Buffer Enable †** - Determines whether or not Windowproc windows will have off-screen buffer. The default "Yes" causes up to 10,240 bytes of memory to be allocated for storage of character data for each new Windowproc window. Memory is first reserved to store on-screen data for the window; additional memory is allocated to store data which has scrolled out of the window. (This data can then be scrolled back into the window.) If this option is not enabled, only enough memory to store the on-screen characters is allocated.
- **Refresh rate** - Sets the display refresh rate to 50 or 60 Hz. Refresh rate should be set to 60 Hz (the default value).

**Keyboard** - Used to set keyboard-related options.

- **Key click** - Determines whether or not key depressions will produce an audible click.

- Volume - Determines volume of key click and bell.
- Repeat rate - Determines keyboard repeat rate (in characters per second).

Mouse - Used to set mouse-related options.

- Hand - Determines the orientation of the mouse buttons for either left- or right-handed use. The mouse buttons are "numbered" 1 through 3, with "button 1" always being associated with the index finger of either hand.
- Acceleration - Determines the speed of the mouse cursor movement in relation to the movement of the mouse itself. The "off" setting (default) causes the mouse cursor to move at the same rate as the mouse itself. The "on" setting enables the user to move the mouse cursor across the screen with less movement of the mouse.

Default Opt - Resets options to their factory default values. Because this selection causes a re-initialization of the terminal, it can only be chosen when no *layers* sessions are in progress. It will cause any current host sessions to be terminated and the screen to appear as it does after the terminal is powered on.

## Default Settings

The following table shows all Setup options and their default values. Unless noted otherwise, new option settings take effect immediately.

**Table 7-1** Setup Options

Level 1	Option	Choices	Default	Notes
Host1	Physical Port	Main EIA, Aux EIA, Unused	Main EIA	1,5
	Options			
	Speed	300, 1200, 2400, 4800, 9600, 19200	9600	
	Parity	None, Odd, Even	None	
	Bits/Char	8, 7	8	
	Rcv Flow	Off, On	Off	
	Local Echo	Off, On	Off	
	Encoding	Off, On	Off	
	Gen Flow	Off, On	On	
	Return	CR, LF, CR/LF	CR	
	Received Newline	LF, CR/LF	LF	
	Font Size	Small, Medium, Large	Large	7
	Layers Window Cols	2 to 140	80	6
	Layers Window Rows	2 to 69	24	6
	Non-Layers Window Cols	2 to 140	80	6
	Non-Layers Window Rows	2 to 69	60	6
	Fixed Non-Layers Window	No, Yes	Yes	2

Level 1	Option	Choices	Default	Notes
Host2	Physical Port	Main EIA, Aux EIA, Unused	Unused	1,3,5
Printer	Physical Port Options	Aux EIA, Unused	Aux EIA	
	Speed	300, 1200, 2400, 4800, 9600, 19200	9600	
	Parity Bits/Char	None, Odd, Even	None	
	Expand Tabs	8, 7	8	
Display	Filter Escapes	No, Yes	Yes	4
	Background Cursor Controls	Dark, Light No Blink, Blink Visible, Invisible, Spaces	Dark No Blink Visible	
Keyboard	Windows Buffer Enable	Basic, Enhanced	Enhanced	
	Refresh Rate	No, Yes 50Hz Refresh, 60Hz Refresh	Yes 60Hz Refresh	
Keyboard	Key Click	Off, On	Off	
	Volume	Off, Levels 1 to 6, Full Vol	Level 4	
	Repeat Rate	15cps, 20cps, 30cps, 60cps	15cps	
Mouse	Acceleration Hand	Off, On Right, Left	Off Right	
Default Opt	Confirm			

**Notes:**

- 1 Not allowed if any windows are active on the logical host.
- 2 Does not take effect until the next reinitialization of *non-layers* on the host (at power up, after selftest, or after an exit on that host).
- 3 Options for Host2 are the same as for Host1, but are only displayed if Host2 is assigned a physical port.
- 4 Does not take effect until next power up.
- 5 SSI and Main2 EIA will also appear as selections if the optional interface card is installed in the terminal. For the SSI Physical Port, only the Font Size, Window Cols, and Window Rows options are selectable.
- 6 Valid range depends on current font setting.
- 7 Valid selections depend on current rows and cols settings.

---

## **Exiting Setup**

To remove the Setup menu but retain the Setup window, click Button 1 outside the menu. Use the Delete command on the main terminal menu when you are ready to remove the Setup window.



---

## Notes on Use of Setup

A logical device cannot be associated with a physical port which is currently assigned to another logical device. (e.g., Printer must be made Unused before the Aux EIA physical port can be associated with Host2.)

Because options apply to the physical port selected, the physical port should be selected for a logical device *before* any options are set for it.

In some cases, Font Size must be made smaller before the Cols and Rows options can be set to given values. Cols and Rows values which are too large to be represented in the currently selected font are displayed in half-intensity font and are not selectable.

Similarly, Cols and Rows values may need to be made smaller before a larger Font Size can be selected.

Cables must be of the appropriate type for communication with the host or printer. See ordering information in Chapter 1.

---

## Power On Configuration

Terminal option settings determine the appearance of the screen after the terminal is powered on.

If logical Host1 is assigned to a physical port, then a *non-layers* window will be created for Host1 with its upper left corner positioned at the upper left corner of the screen. (This is the default case.)

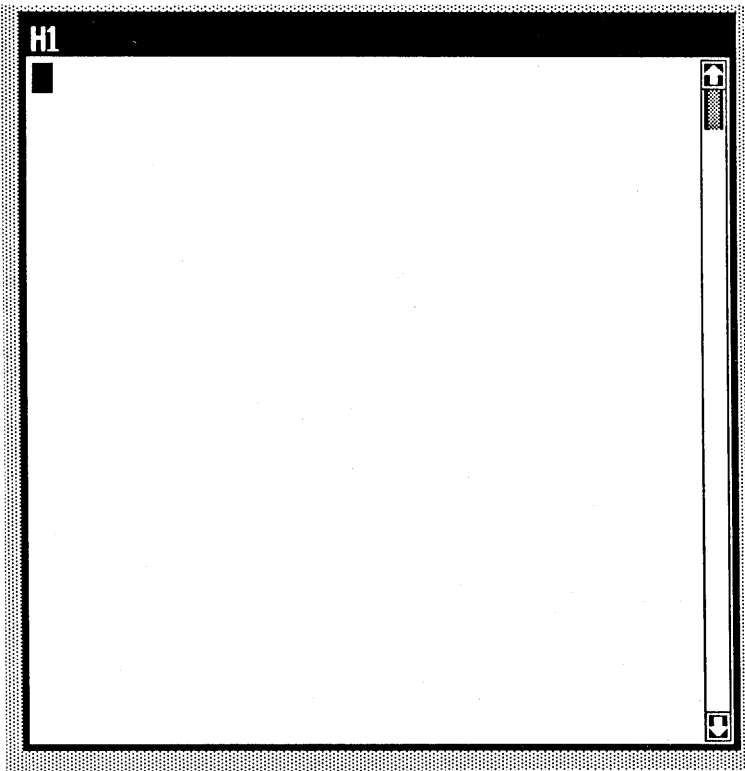

**Figure 7-4** Default Power On Window

---

Otherwise, if logical Host2 is assigned to a physical port, then a *non-layers* window will be created for Host2 with its lower right corner positioned at the lower right corner of the screen.

The window's size depends on the Font Size selection and the Non-Layers Window Rows and Cols options for the logical host device.

If neither logical host device has been assigned a physical port, no windows will be created.

---

## Sample Configuration 1 --- Changing Baud

Following is an example of a typical Setup session. The user wishes to connect the terminal to a host via the Main EIA port. The connection is to be made through a 1200 baud modem. Because the default baud setting is 9600, this option must be changed.

Assuming the terminal is currently configured with default settings for all options, the following sequence of operations will be necessary to configure the terminal as described:

- 1 Use Button 3 to choose Setup under More and position the window near the left side of the screen, as described under "Entering Setup".
- 2 Move the mouse cursor so that it is over the Setup icon.
- 3 Depress Button 1 over the icon until the icon is highlighted; release it to bring up the first level menu.
- 4 Host1 is already assigned to Main EIA, so only the data rate for Host1 needs to be adjusted. Slide the Mouse from Host1 to Options to Speed. Move the mouse to the right still further, clicking Button 1 over 1200.
- 5 Verify that the check mark is now beside 1200.
- 6 To exit Setup, click Button 1 outside the menu. Use the Delete command on the main terminal menu to remove the Setup window.

---

## Sample Configuration 2 --- Multiple Hosts

Following is an example of a more complicated Setup session. The user wishes to configure the terminal so that one host is connected to the Main EIA port, a second host is connected to the optional (Main2) EIA port, and a printer is connected to the Aux EIA port.

The requirements of the first host are 9600 baud, even parity, seven bit characters. The second host is accessed over a Local Area Network via a 1200 baud connection. The network uses ASCII control characters for internal flow control, and so the encoding option must be turned on. The user will run *layers* on the second host and wants to display the maximum number of characters possible in each layers window (so the default layers window should be full screen using the smallest resident font). The printer operates at 1200 baud.

Assuming the terminal is currently configured with default settings for all options, the following sequence of operations will be necessary to configure the terminal as described:

- 1 Use Button 3 to choose Setup under More and position the window.
- 2 Move the mouse cursor so that it is over the Setup icon.
- 3 Depress Button 1 over the icon until the icon is highlighted; release it to bring up the first level menu.
- 4 Host1 is already assigned to Main EIA, so only the Options under Host1 need to be adjusted. Slide the Mouse from Host1 to Options to Parity. Move the mouse cursor to the right still further, clicking Button 1 over Even. Note that the check mark has changed to reflect the new setting.
- 5 Position the mouse cursor over Bits/Char by moving it back to the left and down. Choose 7 by sliding to the right and clicking Button 1 over it.
- 6 Return to the main Setup menu. Position the mouse cursor over Host2 and slide to the right over the arrow beside Physical Port. If the optional host card is installed, the selections will appear as shown in Figure 7-5 on the next page.

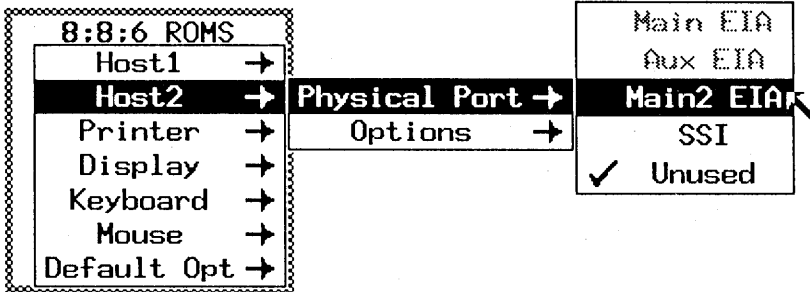

**Figure 7-5** Port Selections with Optional Host Card

---

Choose Main2 EIA using Button 1. Note that Main EIA and Aux EIA are grayed since they are both currently configured.

- 7 Adjust the options for Host2: speed to 1200, encoding to On, Font Size to Small, Layers Window Cols and Rows to 140 and 69, respectively.
- 8 Return again to the main Setup menu. Position the cursor over Printer, slide to the right over Options, and change Speed to 1200.
- 9 Make any desired adjustments to Display, Keyboard, and Mouse option settings.
- 10 To exit the Setup, click Button 1 outside the menu. Use the Delete command on the main terminal menu to remove the Setup window.

---

## Introduction

Eight programmable function keys allow user-definable strings to be sent at the touch of a key. Up to 80 characters may be stored for each PF key. (Keys are initially unprogrammed.)

PF keys depressed with Shift or Control transmit the same codes as they do when unshifted.

User PF key definitions can be viewed or modified using the built-in "PF Edit" program.

---

## Entering PF Edit

**Note:** See Chapter 3 for help using the mouse.

To initiate PF Edit:

- 1 Depress Button 3 on the mouse over the screen background and position the arrow cursor over "More".
- 2 Still holding Button 3 down, slide the mouse to the right until the mouse cursor is within the "More" submenu.
- 3 Position the cursor over "PF Edit" and release Button 3. The outline of the PF Edit window will appear.\*

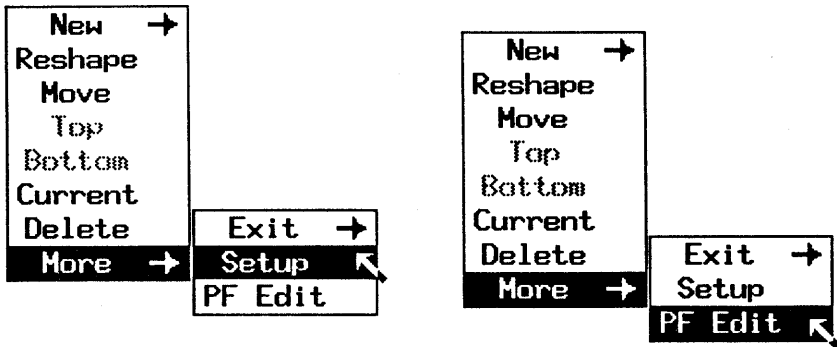

**Figure 8-1** Selecting PF Edit

---

\* Choosing PF Edit from the main terminal menu when the PF Edit window already exists will cause the PF Edit window to become Top and Current.



- 4 Move the mouse to position the window as desired. When the window is positioned, click Button 3.
- 5 The mouse cursor will change to the elongated "x" used for edit mode in Windowproc windows.

```
PF1=lf←  
PF2=echo "\033[?0;0;0x\c"  
PF3=echo "\033[?2;0;0xVi\c"  
PF4=echo "\033[?2;1;1xUpk\c"  
PF5=echo "\033[?4;1;1xDownj\c"  
PF6=echo "\033[?4;1;1xLefth\c"  
PF7=echo "\033[?4;1;1xRightl\c"  
PF8=echo "\033[?5;1;1xRightl\c"
```

Figure 8-2 PF Edit Window

---

---

## Using PF Edit

Current definitions of all eight PF keys are displayed within the PF Edit window. You can modify these definitions using local edit operations similar to those found in Windowproc.

The edit cursor is a caret which appears under and to the left of the current character position. It can be moved by clicking Button 1 or using the arrow keys. Typing will cause text to be inserted at the position of the edit cursor (before the current character). Hitting a PF key while in the PF Edit window will move the edit cursor to the beginning of the corresponding PF definition.

PF Edit uses the same global save buffer as Windowproc (See Chapter 5). Text can be swept using Button 1, pasted from the buffer, or saved or cut into the buffer. In PF Edit, as in Windowproc, the paste, save and cut menu items are on Button 2. To sweep out text in PF Edit or Windowproc do the following:

- 1 Position the mouse cursor at the beginning of the targeted text.
- 2 Depress Button 1.
- 3 Continuing to hold Button 1 down, move the mouse over the text so that it becomes highlighted in reverse video.
- 4 Once the entire text is highlighted, release Button 1.

This body of text can now be saved or cut into the global buffer by using the Save or Cut menu selections on Button 2. Text in the global buffer can be inserted at the position of the edit cursor by choosing Paste from the Button 2 menu.

---

## **Exiting PF Edit**

Changes to PF definitions take effect immediately. Use the Delete command on the main terminal menu when you are ready to remove the PF Edit window.

---

## An Example

Suppose that the user wishes to program each PF key to send "This is PFx", where x is the number of the key. The following series of operations would accomplish this, assuming the keys were not programmed to begin with:

- 1 Choose PF Edit under More and position the window.
- 2 Click Button 1 to position the mouse cursor at the beginning of line 1
- 3 Type "This is PF1".
- 4 Click Button 1 to position the mouse cursor again at the beginning of line 1, which is now just to the left of the "T".
- 5 Depress Button1 and hold it while moving the mouse to the right so that all of the first line except the last character (the "1") is highlighted in reverse video.
- 6 Release Button 1.
- 7 Depress Button 2, causing the PF Edit menu to be displayed. Select Save by positioning the mouse cursor over it and releasing Button 2. The text will be unhighlighted and the menu will disappear.
- 8 Position the edit cursor at the beginning of line 2.
- 9 Select Paste from the Button 2 menu. The second line now reads "This is PF".
- 10 Position the edit cursor after the last character on line 2.
- 11 Type "2".
- 12 Repeat steps 8 through 11 for the remaining keys.

To program a key with text from a Windowproc window:

- 1 Sweep out the text in the Windowproc window using Button 1.
- 2 Make the PF Edit window current by clicking Button 1 inside it. The previously swept text is automatically saved in the global text buffer.
- 3 Position the PF edit cursor at the beginning of the line to be programmed.
- 4 Choose Paste from the Button 2 PF Edit Menu.

---

## Host Software Installation

This section describes installation of the special software required for operating in layers, as well as for downloading and developing 630 application programs. Since this software is installed on the host computer, assistance from your system administrator may be necessary. If you plan to operate your 630 terminal only in the non-layers environment, you may skip the Host Software Installation section in this chapter.

### 630 MTG Software Development Package

The 630 MTG Software Development Package is required to download or develop 630 application programs. See Chapter 1 for ordering information. If you plan to install the 630 MTG Software Development Package, follow the installation instructions in the 630 MTG Software Development Guide rather than the installation instructions in this section.

### AT&T Windowing Utilities

The host software necessary to run layers is called the AT&T Windowing Utilities package. Users will often find that this package has already been installed on their computer. Type `layers` in a non-layers window. If no error message is displayed in response to this command, your host computer is already properly configured to support the layers environment.

If an error message is generated in response to the `layers` command, see the instructions below and consult your system administrator if necessary. The rest of this section describes installation of windowing utilities.

The AT&T Windowing Utilities package is a standard utilities package delivered with the UNIX Operating System beginning with UNIX System V Release 3 (System V Release 2.1.1 for the 3B20). If your computer is running a version of UNIX for which the AT&T Windowing Utilities package is available, install the package as described in your UNIX

documentation.

For earlier versions of UNIX where the AT&T Windowing Utilities package is not available, the same windowing functionality can be obtained by installing the 5620 DMD Core package. See Chapter 1 for ordering information and the 5620 Dot-Mapped Display Administrator Guide for installation instructions.

After you have installed the 5620 DMD Core package, a zero length file must be created in the directory `$DMD/lib/layersys` to inform the 5620 layers program of the 630 terminal version. The name of this file must be in the form:

```
lsys.TERMINAL_VERSION
```

where `TERMINAL_VERSION` is displayed in the 630 Setup window. For example, if the first line of your setup window says:

```
8;8;6 ROMS
```

your `TERMINAL_VERSION` is `8;8;6`, and the zero length file must be called `lsys.8;8;6`. To create the file, change to the directory `$DMD/lib/layersys` and type the command:

```
>"lsys.8;8;6"
```

If engineering modifications are made to the 630 MTG, changed functionality will be reflected in the `TERMINAL_VERSION`. One `lsys.TERMINAL_VERSION` must be created for each unique `TERMINAL_VERSION` type.

If the zero length file for a particular `TERMINAL_VERSION` is missing, the error message "5620 Software - Firmware mismatch. . ." will be displayed when attempting to execute the layers command.

An alternative to creating `lsys.TERMINAL_VERSION` files is to execute layers with the following command line:

```
layers /dev/null
```

---

## User .profile

### TERM variable

630 users should set the **\$TERM** shell variable to **630** by including the following lines in their .profile file:

```
TERM=630
export TERM
```

This is not strictly required to use 630 host software, but rather is required by some UNIX applications such as *vi* which use the UNIX terminfo facility (see the 630 Terminfo section).

### DMD and PATH variables

If you plan to operate your 630 terminal only in the non-layers environment, the rest of this section can be skipped. If you plan to use 630 MTG Software Development Package, refer to the 630 Software Development Guide for information on how to set your **\$DMD** and **\$PATH** variables.

The AT&T Windowing Utilities package is available starting with UNIX System V Release 3 (System V Release 2.1.1 for the 3B20). If your host computer is running a version of UNIX for which the AT&T Windowing Utilities package is available, the **\$DMD** variable does not have to be set and your **\$PATH** variable does not have to be modified.

If your host computer is running a version of UNIX for which the AT&T Windowing Utilities package is not available, you will be using the 5620 DMD Core package for windowing utilities (see previous section). With this configuration, the following host environment must be set to use the 630 in the layers environment:



- The shell variable **\$DMD** must be set to the root of the 5620 Core package tree. The root of the 5620 Core package is usually the directory **/usr/dmd**. If the directory **/usr/dmd** does not exist on your host computer, ask your system administrator where the 5620 Core package is installed.
- The directory **\$DMD/bin** must be added to the **\$PATH** variable.

What follows is an excerpt from a sample .profile which will set up a user's environment to operate a 630 MTG with the 5620 DMD Core package:

```
stty tabs ixon
DMD=/usr/dmd # or wherever the 5620 software is located
PATH=$PATH:$DMD/bin
TERM=630
export DMD PATH TERM
```

---

## 630 Terminfo

A *terminfo* entry for the 630 terminal must be installed in order to use certain visual programs such as *vi*. The 630 terminfo is distributed with UNIX System V Release 3.2. Therefore, this and future Unix releases do not require a special installation of *terminfo*\*. If you have a 630 MTG Software Development Package, a machine readable copy of the 630 terminfo is in the directory `$DMD/terminfo` (Refer to the 630 MTG Software Development Guide for setting up your `.profile` for terminfo). A printed copy of the 630 terminfo is provided on the following page in case you do not have access to the 630 terminfo and must install it on your system.

To test whether a 630 terminfo is already installed on your computer, execute the following command:

```
tput -T630 clear
```

This command will generate an error message saying *unknown terminal* if a 630 terminfo is not installed, otherwise it will clear your screen. If `tput` displays the error message, you will need to install a 630 terminfo. The 630 terminfo can be installed in the system terminfo as described in `tic(1M)` in the UNIX System V Administrator Reference Manual. Installation of the terminfo in the system terminfo may require assistance from your system administrator for root login permission, so an alternative is for users to install the terminfo individually as a local terminfo as discussed in the next section.

---

\* A 5630 terminfo is distributed with UNIX System V Release 3.1 and UNIX System V Release 3.1.1. This terminfo can be used in place of a 630 terminfo by setting the `$TERM` shell variable to 5630 in your `.profile`. In addition, the 5630 terminfo should be modified to resemble the 630 terminfo listed on the following page.

```
#
# 630 terminfo
#
#
630|att630|5630|5630DMD|630MTG|AT&T630 windowing (See Note 1)
terminal @(#)630.ti 1.4,
    am, da, db, mir, msgr, npc, xon,
    cols#80, it#8, lines#60, lm#0,
#
# short descriptions without \E
#
    bel=~G, cr=\r, ht=\t, nel=\r\n,
#
# cursor movement
#
    cuul=\E[A,    cudl=\E[B,    cuf1=\E[C,    cub1=\b,
    cuu=\E[%pl%dA, cud=\E[%pl%dB, cuf=\E[%pl%dC,
    cub=\E[%pl%dD,
    cup=\E[%i%pl%d;%p2%dH,
    home=\E[H,
    cbt=\E[Z,
#
# scrolling
#
    ind=\ED,      ri=\EM,
    indn=\E[%pl%dS, rin=\E[%pl%dT,
#
# character attributes
#
    smul=\E[4m,  rmul=\E[m,
    smso=\E[7m,  rmso=\E[m,
    rev=\E[7m,
    sgr=\E[0?%p2&t;4%;%?%pl%p3%|p4%|p5%|t;7%;m,
    sgr0=\E[m,
#
# clear
#
    el=\E[K, ell=\E[1K, ed=\E[J, clear=\E[H\E[J,
```

**Note 1:** Type this line and the line below as one line when entering the terminfo data.

```

#
# insert/delete
#
    dch1=\E[P, dll1=\E[M, ill1=\E[L,
    dch=\E[%p1%dP, dl1=\E[%p1%dM, il1=\E[%p1%dL, ich=\E[%p1@d@,
    smir=\E[4h, rmir=\E[4l,
#
# pf string
#
    pfx=\E[%p1%d;%p2%l%dq%p2%s,
#
# set/reset
#
    sc=\E7, rc=\E8,
    is2=\E[m, rs2=\Ec,
#
# printer
#
    mc4=\E[?4i, mc5=\E[?5i,
#
# keyboard definitions
#
    kbs=\b, kclr=\E[2J, kent=\r, khome=\E[H, kcbt=\E[Z,
    kcuul=\E[A, kcud1=\E[B, kcufl=\E[C, kcubl=\E[D,
    kf9=\ENo, kf10=\ENp, kf11=\ENq,
    kf12=\ENr, kf13=\ENs, kf14=\ENT,
#
# the following keys are used only by the 122 key keyboard
#
    kdch1=\E[P, kdll1=\E[M,
    kich1=\E[@, kill1=\E[L,
    kf15=\ENU, kf16=\ENV, kf17=\ENw,
    kf18=\ENx, kf19=\ENy, kf20=\ENZ,
    kf21=\EN{, kf22=\EN|, kf23=\EN},
    kf24=\EN~,

```

630-24|att630-24|5630-24|630MTG-24|AT&T 630 (See **Note 2**)  
 windowing terminal 24 lines, @(#)630.ti 1.4,  
 lines#24, use=630,

**Note 2:** Type this line and the line below as one line when entering the terminfo data.

---

## Local Terminfo

If the 630 *terminfo* is not already installed on your system, an alternative to installing it in the system *terminfo*, which may require assistance from your system administrator, is to create a local *terminfo* in your directory. A local *terminfo* will also be required for changing the default size of the non-layers windows (Refer to the Changing the Default Fixed Non-layers Windows section in this chapter).

- 1 Edit your `.profile` to include the lines:

```
TERM=630
TERMINFO=$HOME/.dmdterminfo
export TERM TERMINFO
```

- 2 Log off and then log back on to cause your `.profile` to be executed.
- 3 Execute the following commands:

```
cd
mkdir .dmdterminfo
cd .dmdterminfo
```

- 4 Copy the 630 *terminfo* description (see previous section) into a file called `630terminfo` in your current directory (`.dmdterminfo`).
- 5 Execute the command:

```
tic 630terminfo
```

The above `tic` command will create a local *terminfo* in the directory `$HOME/.dmdterminfo`. For more information about local *terminfo* descriptions, see *tic(1M)* in the UNIX System Administrators Reference Manual.

---

## Changing the Default Fixed Non-Layers Window

The size of the *non-layers* window can be changed from the 60x80 character default in Terminal Setup. If this is done, the above *terminfo* must be changed to reflect the new size of the *non-layers* window.

The following steps will change the default sized *non-layers* window and create an updated *terminfo*:

- 1 In Setup, change Non-Layers Window Cols and/or Non-Layers Window Rows to your desired values. Remember the values you choose.
- 2 Edit the 630 *terminfo*, changing the variable *cols* to the value you set for Non-Layers Window Cols and the variable *lines* to the value you set for Non-Layers Window Rows.
- 3 Create a local *terminfo* from this edited description as described in the previous section of this chapter.

The *non-layers* window will be the new default size the next time it is created, either as a result of exiting layers or by re-initializing the *non-layers* host through Selftest, exiting *non-layers* and doing a New, or cycling the power. The outline used in Reshape and Peel will also reflect the new default size the next time it appears.

# **Chapter 10: Maintenance and Troubleshooting**

---

## **Contents**

---

**Care of the Terminal** 10-1

---

**Testing Operability** 10-2

Automatic Selftest 10-2

User-Initiated Selftest 10-2

Testing the Mouse 10-3

Testing the Keyboard 10-3

---

**Problems/Suggestions** 10-4

# Chapter 1: Overview

---

## Contents

---

**About This Manual** 1-1

---

**Introducing the 630** 1-2

---

**Dependencies** 1-5

Hosts 1-5

UNIX Releases 1-5

---

**Software** 1-6

---

**Hardware** 1-7

---

**Documentation** 1-10



---

## Care of the Terminal

Clean the display screen when needed by dusting with a dry, soft cloth. Heavier contaminants such as fingerprints may be removed with detergent or glass cleaner. Scouring pads, abrasive cleaners, acid, and chlorinated solutions will damage the screen and should not be used. Adhesives may also damage the screen. The terminal's painted surfaces should be protected from harsh cleaning products, ink, adhesives, and cosmetics.

---

## Testing Operability

Selftest is a test of basic terminal operability. It is performed automatically when the 630 is powered on or can be initiated from the keyboard.

### Automatic Selftest

Automatic Selftest is executed every time the 630 is powered on. Included are tests of terminal control software, program memory, and communication ports.

When the test begins, the messages "Selftest" and "630 MTG: COPYRIGHT 1986 - AT&T" will be displayed. The entire test takes approximately 5 seconds. If the test is successful, the message "Selftest Passes" will appear briefly on the screen and then the background pattern will be displayed. Depending on the Terminal Setup option settings, a window may be created (See Chapter 7).

If Selftest fails, an error message describing which part of the test failed will flash five times and then remain displayed until Selftest is complete. If possible, the terminal will resume normal operation, creating a window based on Terminal Setup option settings.

### User-Initiated Selftest

The User-Initiated Selftest performs the same tests as the Automatic Selftest described above and, in addition, tests option storage memory. It can be initiated by simultaneously depressing Shift, Control (Ctrl), and Escape (Esc).

When the test is completed, the terminal screen will appear as it does after power up.

**Note:** The user initiated selftest causes a reset of the terminal. The reset will terminate all operating Host programs.

## Testing the Mouse

**Note:** See Chapter 3 for help using the mouse.

To test that the mouse is operational, do the following:

- 1 Move the mouse back and forth on your work surface. The arrow cursor on the screen should mimic the movement of the mouse.
- 2 Move the mouse cursor so that it is positioned over the screen background.
- 3 Depress and hold Button 3; the main terminal menu will appear.
- 4 Continuing to hold Button 3, move the mouse so that the arrow cursor is outside the menu.
- 5 Release Button 3. The menu will disappear.

## Testing the Keyboard

To test the keyboard, click Button 1 of the mouse over a Windowproc\* window to make it current. Then click Button 1 in that window again to place the window in local edit mode (indicated by the edit icon in the label area). Typed characters will be echoed in the window if the keyboard is operational. Control characters will be displayed only if the "Controls" option under "Display" in Setup is set to "Visible". Press the Escape key (Esc) to return the window to normal operating mode.

---

\* See Chapter 5 for a complete description of Windowproc.

---

## Problems/Suggestions

- Screen is blank
  - press Shift key (sleep mode)
  - adjust brightness and contrast controls
  - check that AC power switch is On
  - check that AC power cord is connected to terminal base
  - check that AC power cord is connected to outlet
- No response to typing in power-up window
  - check that keyboard is connected to terminal base
  - check that modem cable is connected to selected physical port
  - check that logical host is assigned to selected physical port
  - check that scroll lock is off (LED not on)
- No response to typing in other window
  - peel any windows to that host that contain text you want to preserve, then try Exit on Button 3.
  - if Exit fails, disconnect the I/O cable at the rear of the terminal
  - as a last resort, cycle the power
- Get "Terminal is not a 5620 or 5620 failed to respond : Device busy" message after typing layers
  - check that Parity option is set to "None"
  - check that Bits/Char option to set to "8"

- Get "5620 Software - Firmware mismatch. . ." message after typing layers
  - see discussion in Chapter 9 for instructions.
- Bell rings when typing
  - check that there is a current window
  - be sure Setup window is not current
  - check to be sure Scroll Lock is off
- Process exception message at bottom of window
  - make the window current and press any key to continue
- System exception message at bottom of screen
  - press any key to reinitialize the terminal (This terminates all host sessions and any programs which are running.)

# **Chapter 11: Options and Accessories**

---

## **Contents**

---

**Expansion Cards and Accessories** 11-1

---

## Expansion Cards and Accessories

Use this section to file pages which accompany optional 630 expansion cards and accessories.

Currently available expansion cards and accessories are listed below. Additional ones will be offered in the future.

**Table 11-1** Expansion Cards and Accessories

---

<b>Item</b>	<b>Comcode</b>	<b>PE Code</b>
122-Key Keyboard	501004881	33537
SSI/EIA Interface Card and Documentation	524594306	33535
512K RAM Card	501002166	33422
98-Key Keyboard Modification Kit	524604121	33538





---

## Appendix A: Control Characters and Escape Sequences

---

### Control Characters

In the following table, "No action" implies that the control character is displayed, but not acted on by the terminal. The way in which control characters are displayed depends on the "Controls" Setup option.

**Table A-1** CONTROL CHARACTERS

---

CHARACTER	ACTION
NUL	no action
SOH	no action
STX	no action
ETX	no action
EOT	no action
ENQ	no action
ACK	no action
BEL	ring the bell
BS	backspace
HT	horizontal tab
LF	action depends on Received Newline option setting

CHARACTER	ACTION
VT	action depends on Received Newline option setting
FF	action depends on Received Newline option setting
CR	carriage return
SO	no action
SI	no action
DLE	no action
DC1	resume data flow; not acted on if Rcv Flow is No
DC2	turn printer on-line
DC3	stop data flow; not acted on if Rcv Flow is No
DC4	turn printer off-line
NAK	no action
SYN	no action
ETB	no action
CAN	no action
EM	no action
SUB	no action
ESC	begin escape sequence parsing
FS	no action
GS	no action
RS	no action
US	no action

---

## Escape Sequences

### Attributes

Set character attributes (**ESC [ ps1; ps2; ... m**)

**ps** = 0 - normal

**ps** = 2,5,7 - highlight

**ps** = 4 - underscore

Attributes are only guaranteed at the time of display.

### Clear

Clear Line (**ESC [ ps K**)

**ps** = 0, Clear from the cursor, inclusive, to the end of the line.

**ps** = 1, Clear from the beginning of the line to the cursor, inclusive.

**ps** = 2, Clear the entire line.

Clear Screen (**ESC [ ps J**)

**ps** = 0, Clear from the cursor to the end of the buffer.

**ps** = 2, Clear the entire screen and buffer.

### Cursor

Absolute (**ESC [ ps1; ps2 f or H**)

Move the cursor to row **ps1**, column **ps2**. Default is row 1, column 1.

Index (**ESC D**)

Move the cursor down one row (in the same column), scrolling if needed.

Reverse Index (**ESC M**)

Move the cursor up one row (in the same column), scrolling if needed.

Up (**ESC [ ps A**)

Move the cursor up **ps** lines (in the same column), stopping at the top of the window. Default is 1 line.

**Down (ESC [ ps B)**

Move the cursor down **ps** lines (in the same column), stopping at the bottom of the screen. Default is 1 line.

**Right (ESC [ ps C)**

Move the cursor right **ps** columns (in the same row), stopping at the window's edge. Default is 1 column.

**Left (ESC [ ps D)**

Move the cursor left **ps** columns (in the same row), stopping at the window's edge. Default is 1 column.

**Back Tab (ESC [ pn Z)**

Back tab **pn** times on current line. Default is 1.

## Delete

**Characters (ESC [ ps P)**

Delete **ps** characters at the cursor position. All characters to the right of the cursor move **ps** positions to the left.

**Lines (ESC [ ps M)**

Delete **ps** lines at the cursor position. All lines below the cursor to the end of the buffer are moved up **ps** lines.

## Download

Applies only to the *non-layers* environment. (ESC [ ps1; ps2 v)

**ps1** = 0, error; reserved for 5620 download applications

**ps1** = 1, error; reserved for 5620 download applications

**ps1** = 2, enter layers

**ps1** = 3, start non-layers download

**ps1** = 4, start takeover download

**ps2** = 0, set encoding off

**ps2** = 2, set encoding on

**Note:** Because downloading involves "handshaking" between the terminal and host, this sequence should only be invoked by application programs (NOT directly by the user).

## Font

Inquire/Set Terminal Fonts (**ESC [ ? ps1;ps2 u <font name>**)

**ps1** indicates whether this is a font inquiry (**ps1=0**)  
or a command to set the current font (**ps1=1**).

**ps2** is the length of the font name.

If **ps2** is **0**, the name of the font currently being  
used in the window is used.

For a font inquiry, the terminal responds with  
**ESC [ ? ps1;ps2 w <font name>**

where:

**ps1** = 0, font is not in the terminal

**ps1** = 1, font is in the terminal

**ps1** = 2, font is currently in use in the window

**ps2** = length of <font name>

## Insert

Characters (**ESC [ ps @**)

Insert **ps** characters at the cursor position. All characters shifted  
beyond the right window border are lost. Default is 1.

Lines (**ESC [ ps L**)

Insert **ps** lines at the cursor position. Text above the cursor line is  
pushed down by **ps** lines. All data on lines pushed out of the  
buffer is lost.

Insert Mode On (**ESC [ 4 h**)

Enter insert mode. Any character to be displayed is then inserted  
in front of the cursor position and all characters to the right of the  
cursor (inclusive) are moved 1 position to the right.

Insert Mode Off (**ESC [ 4 l**)

Exit insert mode.

## Printer

### Printer On (ESC [ ? 5 i)

Turn the printer on line. (Same as DC2)

### Printer On Request (ESC [ ? 5;1 i)

Same as Printer On, but responds with

**ESC [ ? ps i** where:

**ps = 0** indicates printer was not granted

**ps = 1** indicates printer was granted

### Printer Off (ESC [ ? 4 i)

Turn the printer off line. (Same as DC4)

### Media Copy On Request (ESC [ ? 5;2 i)

Same as Media Copy On, but responds with

**ESC [ ? ps i** where:

**ps = 0** indicates printer was not granted

**ps = 1** indicates printer was granted

### Media Copy On (ESC [ 5 i)

Turn the printer on line. Text will be sent to the printer, but will not be displayed in the window. Tab Expand and Filter Escapes Setup options will be ignored (all escapes will be sent and tabs will not be expanded).

### Media Copy Off (ESC [ 4 i)

Turn the printer off line. (Same as DC4)

## Program

### Program Enter Key (ESC [ 25 ; ps2 | <String>)

Set the enter key definition to the ps2 characters (maximum of 4 characters) in the string following this escape sequence. Handled independently for each window.

### Program PF Key (ESC [ ps1;ps2 q <String>)

Set User PF key definition, where ps1 is the key number (1 - 8) and ps2 is the length of the string (up to 80 characters) to be downloaded into the key.

### Program Menu (ESC [ ? ps1;ps2;ps3 x <item> <string>)

Program a menu entry with the name <item> that sends the string <string> when chosen; entries are appended to the root of the Button 2 Windowproc menu.

ps1 is the length of <item>, ps2 is the length of <string>, and ps3 is the menu depth (0 - 3) the item appears on. The first item must be at depth 0, which will make it a root item (i.e., items cannot be appended to existing Windowproc submenus) If ps1, ps2, ps3 are 0, all previously programmed menu items at all depths are cleared.

### Program Label Area (ESC [ ? ps1;ps2 v <text>)

Put text in the label area of the window;

ps1 is the length of <text>, and ps2 indicates placement.

ps2 = 0, left justify

ps2 = 1, center

ps2 = 2, right justify

If the string is longer than can be displayed in the window's label area, it will be clipped to fit.

## Request

Request Terminal Type (**ESC [ c**)

Terminal responds with **ESC [ ? 8;8;6 c**

Request Terminal Configuration (**ESC [ > c**)

**Terminal responds with ESC [ > ps1;pn1;pn2;ps2 c** where:

**ps1** - keyboard type

0 = none

2 = 98 keys

3 = 122 keys

**pn1** - always 0; reserved for future use

**pn2** - always 0; reserved for future use

**ps2** - RAM size in kilobytes

Request Rows and Cols (**ESC [ ? 10 n**)

The terminal responds with **ESC [ ? ps1;ps2 R** where **ps1** is the number of rows and **ps2** the number of columns in the current window.

Request Cursor Position (**ESC [ 6 n**)

The terminal responds with **ESC [ row;column R**.

Request if encoding is set (**ESC [ F**)

The terminal responds with **ESC [ ps F** where

**ps** = 0 if encoding is not set and

**ps** = 1 if encoding is set.

This sequence is not compatible with the ANSI 3.64 standard.

## Reset

Reset window (**ESC c**)

Reset the window as though it were just created.



## Reshape

### Affect Reshapability (ESC [ ? ps r)

Make the window reshapable/non-reshapable.

**ps** = 0, make the window non-reshapable

**ps** = 1, make the window reshapable

**ps** = 2, inquire if the window is reshapable

If **ps** = 2, the terminal responds with:

**ESC [ ? ps r** where

**ps** = 0 indicates non-reshapable and

**ps** = 1 indicates reshapable.

### Reshape Window (ESC [ ? lines;columns s)

Reshape the window to **lines** by **columns**.

## Restore

### Restore (ESC 8)

Restore from **ESC 7**. The cursor moves to the saved position, and the attributes and font are set to the saved values.

## Save

### Save (ESC 7)

Save the cursor position, character attributes, and font in use.

## Scroll

### Up (ESC [ ps S)

Scroll up **ps** lines. If the bottom of the buffer is reached, empty lines will be scrolled in.

### Down (ESC [ ps T)

Scroll down **ps** lines. If the top of the buffer is reached, empty lines will be scrolled in.



---

## Appendix B: 98-Key Keyboard

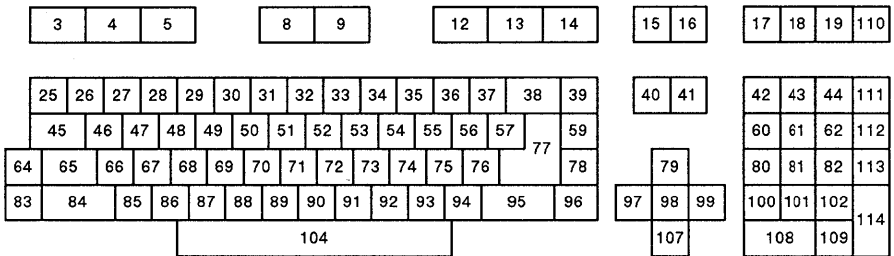

**Figure B-1** Key Position Numbers

---

**Table B-1** Key Codes

98-Key Keyboard Transmitted Codes					
Description	Position	Raw Code*	Hexadecimal Codes Sent		
			Unshift	Shift	Control
F1	3	20	Up to 80 programmed characters		
F2	4	26	Up to 80 programmed characters		
F3	5	05	Up to 80 programmed characters		
F4	8	3e	Up to 80 programmed characters		
F5	9	50	Up to 80 programmed characters		
F6	12	42	Up to 80 programmed characters		
F7	13	03	Up to 80 programmed characters		
F8	14	2c	Up to 80 programmed characters		
F9	15	06	ESC No	ESC NO	ESC NO
F10	16	0d	ESC Np	ESC NP	ESC NP
F11	17	67	ESC Nq	ESC NQ	ESC NQ
F12	18	7d	ESC Nr	ESC NR	ESC NR
F13	19	72	ESC Ns	ESC NS	ESC NS
ESC	25	62	1b	1b	1b
1 !	26	68	31	21	
2 @ NUL	27	6e	32	40	00
3 #	28	22	33	23	
4 \$	29	15	34	24	
5 %	30	63	35	25	
6 ^ RS	31	74	36	5e	1e
7 &	32	02	37	26	
8 *	33	08	38	2a	
9 (	34	24	39	28	
0 )	35	2a	30	29	
- _ US	36	30	2d	5f	1f
= +	37	2b	3d	2b	
BACK SPACE	38	64	08	08	08
DLETE	39	18	7f	7f	7f
BREAK DISCON	40	0e	break		disconnect
CLEAR RESET	41	5b	ESC [2J		ESC c
= ( (pad)	42	49	3d	28	28
* ) (pad)	43	11	2a	29	29
/ (pad)	44	61	2f	2f	2f

98-Key Keyboard Transmitted Codes					
Description	Position	Raw Code*	Hexadecimal Codes Sent		
			Unshift	Shift	Control
TAB	45	4a	09	ESC [Z	ESC [Z
Q DC1	46	56	71	51	11
W ETB	47	1c	77	57	17
E ENQ	48	0f	65	45	05
R DC2	49	5d	72	52	12
T DC4	50	57	74	54	14
Y EM	51	7a	79	59	19
U NAK	52	1a	75	55	15
I HT	53	0c	69	49	09
O SI	54	1f	6f	4f	0f
P DLE	55	25	70	50	10
[ { ESC	56	10	5b	7b	1b
] } GS	57	5e	5d	7d	1d
' -	59	55	60	7e	
7 (pad)	60	32	37	37	37
8 (pad)	61	12	38	38	38
9 (pad)	62	2f	39	39	39
CAPS LOCK	64	71			
CTRL	65	44			
A SOH	66	5c	61	41	01
S DC3	67	4c	73	53	13
D EOT	68	09	64	44	04
F ACK	69	69	66	46	06
G BEL	70	4b	67	47	07
H BS	71	3f	68	48	08
J LF	72	14	6a	4a	0a
K VT	73	37	6b	4b	0b
L FF	74	19	6c	4c	0c
::	75	0a	3b	3a	
' "	76	16	27	22	
RETURN	77	6a		CR or LF or CR-LF	
\   FS	78	3d	5c	7c	1c
↑	79	17	ESC [A	ESC [A	ESC [A
4 (pad)	80	1b	34	34	34
5 (pad)	81	75	35	35	35
6 (pad)	82	23	36	36	36
SCROLL LOCK	83	27			
SHIFT	84	41			
Z SUB	85	01	7a	5a	1a
X CAN	86	6f	78	58	18
C ETX	87	51	63	43	03
V SYN	88	45	76	56	16

98-Key Keyboard Transmitted Codes					
Description	Position	Raw Code*	Hexadecimal Codes Sent		
			Unshift	Shift	Control
B STX	89	33	62	42	02
N SO	90	21	6e	4e	0e
M CR	91	28	6d	4d	0d
, < NUL	92	70	2c	3c	00
. > RS	93	58	2e	3e	1e
/ ? US	94	52	2f	3f	1f
SHIFT	95	34			
ENTER	96	04	Up to 4 programmed characters		
←	97	13	ESC [D	ESC [D	ESC [D
HOME	98	31	ESC [H	ESC [H	ESC [H
→	99	4f	ESC [C	ESC [C	ESC [C
1 (pad)	100	6d	31	31	31
2 (pad)	101	6b	32	32	32
3 (pad)	102	78	33	33	33
SPACE	104	5f	20	20	20
↓	107	76	ESC [B	ESC [B	ESC [B
0 (pad)	108	53	30	30	30
. (pad)	109	2e	2e	2e	2e
F14	110	7e	ESC Nt	ESC NT	ESC NT
+ (pad)	111	7f	2b	2b	2b
- (pad)	112	73	2d	2d	2d
, (pad)	113	35	2c	2c	2c
ENTER (pad)	114	00	Up to 4 programmed characters		

\* Raw codes shown are for upstrokes of a key. Downstroke codes have the eighth bit set to 1. These codes are for use with the NOTRANSLATE mode.

---

## Glossary

Following are terms and definitions commonly associated with terminal operation.

**AC**

Alternating current

**ANSI**

American National Standards Institute

**ASCII**

American Standard Code for Information Interchange

**asynchronous**

A type of serial communication that does not require that the host and terminal be operating at synchronized frequencies. The 630 MTG is an asynchronous terminal.

**AT&T**

American Telephone and Telegraph

**Aux**

Auxiliary (Port)

**backspace**

This function, when operated from the keyboard, will cause a cursor left function on the display.

**bit**

One of eight pulses (or spaces) used to generate a character.

**bracket**

Left = " [ ", Hex 5B Right = " ] ", Hex 5D

---

**buffer**

Character storage to or from the display

**byte**

Character space

**Char**

Character

**character attribute**

Any character feature such as blink, underscore, subdued intensity, reverse video, or blanking.

**Checksum**

Number adding routine

**Col**

Column(s)

**Comcode**

Commercial ordering code

**Controller**

Terminal logic processor

**Ctrl**

Control key

**CSA**

Canadian Standards Association

**cursor**

An indicator (on the screen) of where the action takes place.

**DC1-4**

Device control or flow control

**default**

The beginning or original settings

**Display**

Cathode ray tube, the enclosure, and the electronics inside

**DMD**

Dot Mapped Display



---

<b>DTR</b>	Data Terminal Ready
<b>EC</b>	Display symbol for the ASCII character (ESCAPE, Hex 1B).
<b>EIA</b>	Electronic Industries Association, an organization responsible for setting industry standards, one of which is a widely used telecommunications voltage interface, EIA RS-232-C (CCITT V.24)
<b>ESC</b>	Keytop symbol for the ASCII character (ESCAPE, Hex 1B). When shown on the screen, the letters EC are shown
<b>FCC</b>	Federal Communications Commission
<b>FF</b>	Form Feed - advance to next page
<b>Firmware</b>	Stored software (ROM, PROM, EPROM)
<b>Fkey</b>	Function key (F1, F2 etc)
<b>flow control</b>	The ability to stop and start data transmission, such as DC1 and DC3 or pin voltage levels.
<b>font</b>	Alphanumeric group of characters and symbols.
<b>full duplex</b>	Simultaneous send/receive of data.
<b>gen</b>	Generate
<b>home</b>	Line one, column one position on the display.

---

<b>Host</b>	Customer provided processor, computer, or terminal.
<b>Hz</b>	Hertz (or cycles)
<b>H1/H2</b>	Window designator for Host1 or Host2
<b>icon</b>	Visual symbol
<b>I/O</b>	Input/Output
<b>Kbyte</b>	Kilobyte
<b>layers</b>	Window environment to Hosts
<b>login</b>	Sign in routine
<b>menu</b>	A screen presentation of the option or edit selection
<b>mnemonic</b>	Program code
<b>modem</b>	Line converter, digital-to-tone signal or a digital-to-digital signal (modulator - demodulator)
<b>mouse</b>	Button operated selection device
<b>MTG</b>	Multi-tasking Graphics
<b>multi-tasking</b>	Operating in simultaneous multiple programs
<b>parity</b>	An accuracy check for transmitted data that uses the eighth bit of each transmitted character.

---

<b>PE</b>	Price Element (code)
<b>PFKey</b>	Program Function
<b>pixel</b>	Screen dots
<b>pn</b>	Numeric Parameter - refers to a whole number (0-9) used in an escape or control sequence, that signifies the corresponding numeric value.
<b>ps</b>	Selective Parameter - refers to a numbered list of defined options used in an escape or control sequence.
<b>Raster</b>	Background area of the screen.
<b>RAM</b>	Random Access Memory
<b>RCV</b>	Receive
<b>ROM</b>	Read Only Memory
<b>RS-232-C Standard</b>	A common EIA serial interface
<b>screen</b>	The glass viewing area
<b>SSI</b>	Standard Serial Interface
<b>terminal</b>	A generic name for the display unit, the keyboard, and the cables.
<b>terminfo</b>	Terminal information file

---

**vac**

Volts alternating current

**UNIX**

A trademarked AT&T operating system

**User's Guide**

A document that describes the terminal operation

**Windowproc**

A terminal emulator program between the host and the user.  
Defines the terminal's response to ANSI 3.64 ASCII sequences.  
Refer to page 5-1 for details.

**Windows**

Viewing area of a workspace

**w/o**

Without

**XON/XOFF**

Transmitter on or off

**Ya, Yb**

Low voltage signal identification

**Za, Zb**

Low voltage signal identification

---

# Index

**5310/5320 Teleprinters** 6-6  
**630 MTG Software Development Package** 9-1  
**630 Native Terminal Emulator** 5-1  
**630 Terminfo** 9-5  
**98-Key Keyboard**  
Appendix B: 98-Key Keyboard B-1

## A

**About This Manual** 1-1  
**AC Power Cord** 2-8  
**Adjustments** 2-10  
Brightness 2-10  
Contrast 2-11  
Swivel 2-12  
Tilt 2-11  
**An Example** 8-6  
**Appearance** 5-2  
Label Area 5-3  
Scroll Area 5-5  
Text Area 5-3  
**Appendix A: Control Characters and Escape Sequences** A-1  
**Appendix B: 98-Key Keyboard** B-1  
**AT&T 475 and AT&T 476** 6-8  
**AT&T Windowing Utilities** 9-1  
**Attaching the Base to the Display** 2-6  
**Attributes** A-3  
**Automatic Selftest** 10-2

## B

**Bottom** 4-19  
**Brightness** 2-10

**Buffer** 5-20  
**Buffer Enable** 5-7  
**Button 1** 5-9  
**Button 2** 5-12  
**Button 3** 5-12  
**Button Definitions** 3-3

## C

**Care of the Terminal** 10-1  
**Changing the Default Fixed Non-Layers Window** 9-9  
**Clear** A-3  
**Configuration** 2-13  
**Connections** 2-8  
AC Power Cord 2-8  
Interface Cables 2-9  
Keyboard Cable 2-9  
Mouse Cable 2-9  
**Contrast** 2-11  
**Control Characters and Escape Sequences**  
Appendix A: Control Characters and Escape Sequences A-1  
Control Characters A-1  
Escape Sequences A-3  
**Control Characters** A-1  
**Controller Base** 2-4  
**Current** 4-19  
**Cursor** A-3  
**Cut** 5-15

---

## D

**Default Settings** 7-14  
**Delete** 4-21, A-4  
**Dependencies** 1-5  
    Hosts 1-5  
    UNIX Releases 1-5  
**Display** 2-5  
**DMD and PATH variables** 9-3  
**Documentation** 1-10  
**Download** A-4

## E

**Edit** 5-13  
    Cut 5-15  
    Global Save Buffer 5-14  
    Mode 5-15  
    Paste 5-15  
    Save 5-15  
    Send 5-14  
    Typing in Edit Mode 5-13  
    Using Local Edit 5-16  
**Entering PF Edit** 8-2  
**Entering Setup** 7-2  
**Escape Sequences** A-3  
    Attributes A-3  
    Clear A-3  
    Cursor A-3  
    Delete A-4  
    Download A-4  
    Font A-5  
    Insert A-5  
    Printer A-6  
    Program A-7  
    Request A-8  
    Reset A-8  
    Reshape A-9  
    Restore A-9  
    Save A-9  
    Scroll A-9  
**Exit** 4-21  
**Exiting PF Edit** 8-5  
**Exiting Setup** 7-16  
**Expansion Cards and Accessories** 11-1

## F

**Fixed Non-Layers Window** 5-8  
**Font** 5-18, A-5  
**Font Size** 5-8

## G

**Global Save Buffer** 5-14  
**Glossary** GL-1

## H

**Hardware** 1-7  
**Host Software Installation** 9-1  
    630 MTG Software Development  
    Package 9-1  
    AT&T Windowing Utilities 9-1  
**Hosts** 1-5

## I

**Index** IN-1  
**Insert** A-5  
**Installation**  
    Adjustments 2-10  
    Attaching the Base to the Display -  
    2-6  
    Connections 2-8  
    Keypop Replacement 2-14  
    Packaging 2-1  
    Power On 2-13  
**Interface Cables** 2-9  
**Introducing the 630** 1-2  
**Introduction** 3-1, 4-1, 6-1, 7-1, -  
    8-1

## K

**Keyboard** 2-1  
**Keyboard Cable** 2-9  
**Keypop Replacement** 2-14

---

## L

- Label Area** 5-3
- Layers Automatic Screen Configuration** 4-7
- Layers Window Manager** 4-4
- Local Termino** 9-8
- Local Windows** 4-23

## M

- Main Terminal Menu** 4-10
- Maintenance and Troubleshooting**
  - Care of the Terminal 10-1
  - Problems/Suggestions 10-4
  - Testing Operability 10-2
- Mode** 5-15
- Mouse** 2-3
- Mouse and Menu Operation**
  - Button Definitions 3-3
  - Introduction 3-1
  - Mouse Menus 3-4
  - Using the Mouse 3-2
- Mouse Cable** 2-9
- Mouse Cursor** 4-11
- Mouse Menus** 3-4
- Mouse Operations in Windowproc** 5-9
  - Button 1 5-9
  - Button 2 5-12
  - Button 3 5-12
- Move** 4-17

## N

- New** 4-13
- Notes on Use of Setup** 7-17

## O

- Options and Accessories**
  - Expansion Cards and Accessories - 11-1
- Overview**
  - About This Manual 1-1
  - Dependencies 1-5

- Documentation** 1-10
- Hardware** 1-7
- Introducing the 630** 1-2
- Software** 1-6

## P

- Packaging** 2-1
  - Controller Base 2-4
  - Display 2-5
  - Keyboard 2-1
  - Mouse 2-3
- Paste** 5-15
- Peel** 5-20
- PF Keys**
  - An Example 8-6
  - Entering PF Edit 8-2
  - Exiting PF Edit 8-5
  - Introduction 8-1
  - Using PF Edit 8-4
- Power On Configuration** 7-18
- Power On** 2-13
  - Configuration 2-13
  - Verifying Operability 2-13
- Print** 5-22
- Printer** A-6
- Printer Cables** 6-11
- Printing**
  - Introduction 6-1
  - Printer Cables 6-11
  - Printing Using Escape Sequences - 6-4
  - Printing Using Windowproc Menus 6-2
  - Supported Printers 6-6
- Printing Using Escape Sequences** 6-4
- Printing Using Windowproc Menus** 6-2
- Problems/Suggestions** 10-4
- Program** A-7
- Programming in Windowproc** 5-23
  - Programming the Label Area 5-23
  - Programming the Menu 5-24
- Programming the Label Area** 5-23
- Programming the Menu** 5-24

---

## R

**Request** A-8  
**Reset** A-8  
**Reshape** 4-15, A-9  
**Restore** A-9

## S

**Sample Configuration 1 --- Changing**  
  **Baud** 7-20  
**Sample Configuration 2 --- Multiple**  
  **Hosts** 7-21  
**Save** 5-15, A-9  
**Scroll** A-9  
**Scroll Area** 5-5  
**Send** 5-14  
**Software** 1-6  
**Software Support**  
  630 Termino 9-5  
  Changing the Default Fixed Non-  
  Layers Window 9-9  
  Host Software Installation 9-1  
  Local Termino 9-8  
  User .profile 9-3  
**Supported Printers** 6-6  
  5310/5320 Teleprinters 6-6  
  AT&T 475 and AT&T 476 6-8  
**Swivel** 2-12

## T

**TERM variable** 9-3  
**Terminal Setup**  
  Default Settings 7-14  
  Entering Setup 7-2  
  Exiting Setup 7-16  
  Introduction 7-1  
  Notes on Use of Setup 7-17  
  Power On Configuration 7-18  
  Sample Configuration 1 ---  
    Changing Baud 7-20  
  Sample Configuration 2 --- Multiple  
    Hosts 7-21  
  Viewing and Modifying Options 7-6

**Testing Operability** 10-2  
  Automatic Selftest 10-2  
  Testing the Keyboard 10-3  
  Testing the Mouse 10-3  
  User-Initiated Selftest 10-2  
**Testing the Keyboard** 10-3  
**Testing the Mouse** 10-3  
**Text Area** 5-3  
**Tilt** 2-11  
**Top** 4-19  
**Typing in Edit Mode** 5-13

## U

**UNIX Releases** 1-5  
**User .profile** 9-3  
  DMD and PATH variables 9-3  
  TERM variable 9-3  
**User-Initiated Selftest** 10-2  
**Using Local Edit** 5-16  
**Using PF Edit** 8-4  
**Using the Mouse** 3-2

## V

**Verifying Operability** 2-13  
**Viewing and Modifying Options** 7-6

## W

**What is a Window?** 4-2  
**Window Commands** 4-13  
  Bottom 4-19  
  Current 4-19  
  Delete 4-21  
  Exit 4-21  
  Move 4-17  
  New 4-13  
  Reshape 4-15  
  Top 4-19  
**Window Size** 5-8  
**Windowing Operations**  
  Introduction 4-1  
  Layers Automatic Screen  
  Configuration 4-7



---

- Layers Window Manager 4-4
- Local Windows 4-23
- Main Terminal Menu 4-10
- Mouse Cursor 4-11
- What is a Window? 4-2
- Window Commands 4-13
- Windowproc**
  - 630 Native Terminal Emulator 5-1
  - Appearance 5-2
  - Mouse Operations in Windowproc - 5-9
- Windowproc Operations** 5-13
  - Buffer 5-20
  - Edit 5-13
  - Font 5-18
  - Peel 5-20
  - Print 5-22
- Windowproc**
  - Programming in Windowproc 5-23
- Windowproc Setup Options** 5-7
  - Buffer Enable 5-7
  - Fixed Non-Layers Window 5-8
  - Font Size 5-8
  - Window Size 5-8
  - Windows 5-7
- Windowproc**
  - Windowproc Operations 5-13
  - Windowproc Setup Options 5-7
- Windows** 5-7

